

M

IBM

Reference Manual

305 RAMAC

IBM Reference Manual

305 RAMAC

CONTENTS

	<i>Page</i>		<i>Page</i>
INTRODUCTION	5	Tape-Controlled Carriage	108
Random Access Method of Accounting and Control.....	5	Operating Features	113
IBM Punched-Card Approach	5	Form Control	115
IBM 305 RAMAC Approach.....	7	Multiple Line Printing	120
System Organization	9	Timing Chart	123
PROGRAMMING	13	323 CARD PUNCH.....	125
Loading the Program	21	Feed and Punch Unit	126
Arithmetic Operations	30	Operating Keys and Lights	126
Clearing Disk Storage	39	323 Control Panel	127
Loading Disk Storage	41	Timing Chart	132
Unloading Disk Storage.....	44	ERROR CORRECTION PROCEDURES.....	134
Other Logic Elements	45	Processing Errors	134
DISK STORAGE ORGANIZATION.....	49	Printer Errors	136
Indirect Addressing	50	Punch Errors	137
INTERNAL CHECKING	63	WIRING AND OPERATING SUGGESTIONS.....	139
380 CONSOLE	68	Wiring Rules	139
CONSOLE OPERATING PROCEDURES.....	78	Wiring and Programming Suggestions	144
Start-Stop Procedures	78	Operating Hints	148
Inquiries	79	SPECIAL FEATURES	149
Alterations to Drum Tracks	80	323 Punch	149
Testing Procedures	80	Printer Output Track.....	153
380 CONSOLE TYPEWRITER.....	82	305 Process Unit	153
Typewriter Control Panel	82	Division	155
Operating Features	91	Additional 350 Disk Storage	160
370 PRINTER	99	Dual Access	160
Operating Keys and Lights	100	CONTROL PANEL SUMMARY	167
Printer Control Panel	101	SYSTEMS SUMMARY	177

RAMAC[®] is a registered trademark that has been coined from the expression Random Access Method of Accounting and Control. The IBM 305 is the first of a series of machines designed to approach in-line accounting on a mechanized basis. This approach requires the use of a storage device that permits rapid access to any of several million characters of data comprising the accounting records.

The IBM 305 RAMAC consists of the following machine units:

- | | |
|---------------------|------------------|
| 305 Processing Unit | 350 Disk Storage |
| 323 Card Punch | 370 Printer |
| 340 Power Supply | 380 Console |

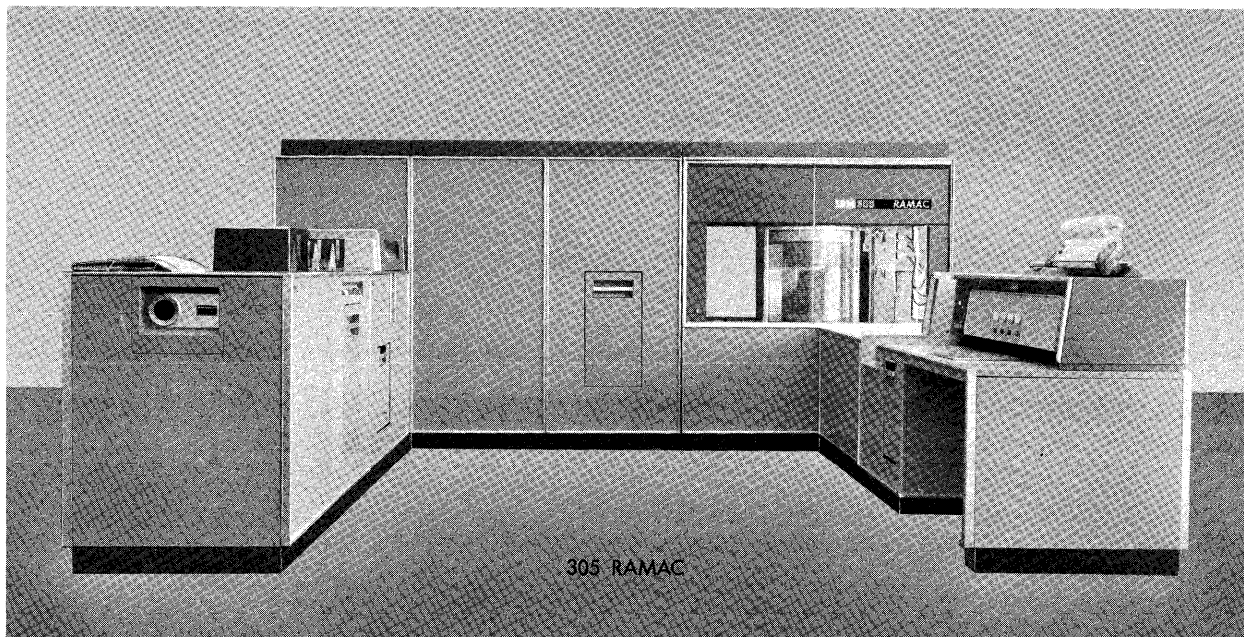

RANDOM ACCESS METHOD OF ACCOUNTING AND CONTROL

BEFORE the development of mechanized accounting, business records were maintained in a series of ledgers by clerks who posted each transaction to the proper accounts. For example, if a manufacturing company bought raw material, the clerk subtracted the cost of the material from the cash account and added the cost to the raw material account. This system of accounting was slow, and subject to clerical errors, but it had the inherent advantage that the accounts were constantly maintained in balance.

An important feature of this system of bookkeeping is that the clerk had access to all the accounts in random order. In the example just mentioned, the clerk changed the balances in the cash account and the raw material account. The next transaction could reflect the fact that some of the raw material had entered the manufacturing process, in which case the clerk would subtract this amount from the raw material account and add it to the material-in-process account. However, it is more probable that the next transaction would affect entirely different accounts. Perhaps some of the finished products were sent to the wholesaler. This transaction would affect the inventory and accounts receivable balances. Because the clerk has direct access to all of these accounts, he can complete the posting of each transaction before beginning the posting of the next. This accounting method is called *in-line processing*. In-line processing has previously not been practical in automatic accounting systems because of the difficulty of reaching and changing single records in large files. However, with the introduction of the IBM 305 RAMAC which is built around a random-access disk storage unit that permits the storage of 5,000,000 characters of business facts (the equivalent of 62,500 80-column IBM cards), in-line processing is now a practical reality.

The storage is organized into 50,000 100-character records which are used to store master information, and previous balances. For processing, the machine can obtain any of these 50,000 records without scanning through the intervening records.

These master and balance records may be considered roughly analogous to the ledgers used in the manual systems of accounting. Each record may contain the equivalent of the last entry to an open-item account. In general, the records should be thought of as the master files used in punched-card accounting. Repetitive information and balances are stored in the disk storage unit. The detail information is usually maintained on IBM cards. The machine performs all bookkeeping functions in posting transactions to the proper accounts. This facility, and the ability to reach any of the records directly, permits the machine to perform in-line processing.

IBM PUNCHED-CARD APPROACH

FIGURE 1 shows a simplified flow-chart for the offset card order method of inventory control and invoicing, using conventional punched-card equipment. The orders, receipts and other transactions that will change the inventory are punched into IBM cards and verified. All orders are given a manual credit check. The stock editor determines whether an order can be filled, and files the transaction cards behind the corresponding balance cards in an oversize card tray, with the balance card and the transaction cards offset from the body of the file. At the end of the filing operation, the offset cards are manually removed from the file and run through an accounting machine that produces a transaction register and summary punches a new inventory balance card. The revised inventory card is interpreted and refiled in the inventory balance file.

The order cards and returns cards are sorted out and run through a calculator to obtain extensions. The cal-

IBM PUNCHED CARD APPROACH

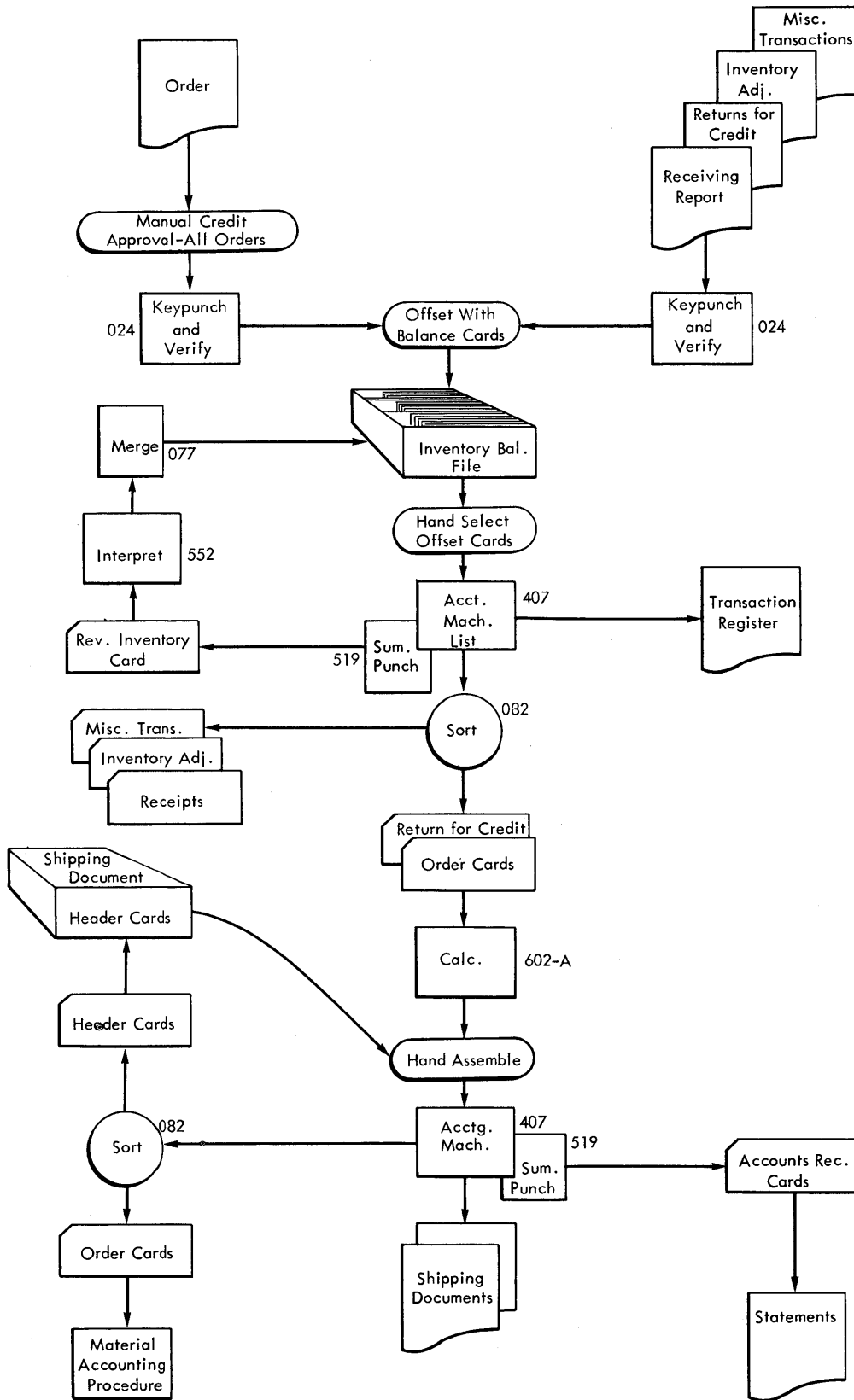

Figure 1. Flow Chart of Inventory, Billing and Accounts Receivable

culated cards are assembled by hand with heading cards and run through the accounting machine to produce the invoice and other shipping documents. Simultaneously, accounts receivable cards are punched which are later used for billing. The source cards are sorted; the heading cards are returned to the file while the order cards enter the material accounting procedure.

This method of inventory control has been extremely successful. However, a considerable amount of manual editing and filing is required, and cards must be processed through seven different machines.

IBM 305 RAMAC APPROACH

BECAUSE the files are located *in the machine*, most of the preceding manual steps are eliminated when the same application is done on the IBM 305. Figure 2 shows the RAMAC approach. The cards are punched and verified as before, but because the machine will do the editing and credit checks, these steps are eliminated. The cards are placed in the input hopper, and the machine, through programming,

1. determines availability of each item ordered,
2. prices each item,
3. adjusts stock balances in the memory,
4. prints out an invoice,
5. punches transaction cards from which a transaction register can be listed,
6. punches accounts receivable cards which can be combined with the transaction cards to list detailed statements,
7. punches a warning card whenever the balance of an inventory item drops below a predetermined level,
8. punches a back-order card for each item back-ordered, and
9. accumulates usage data, which can be unloaded at intervals for sales analyses.

Using the offset punched-card system, all the filing must be done before the cards are run through the accounting machine. Under the RAMAC system, the cards may be inserted at any time, without sorting.

The console, which is part of the RAMAC system, contains a keyboard and a typewriter that allow an operator to make inquiries into the status of any account in the disk storage unit. Because the accounts are constantly being posted, this inquiry allows the operator to obtain a truly *current* balance almost instantly.

Because the machine can perform logical operations under the control of its program, such routine clerical functions as determining whether there is enough stock to fill an order, whether the stock has dropped below the re-order point, or whether the customer has exceeded his allowed credit can be performed automatically by the machine. For example, as each invoice is written, a credit check can be made to determine if the sale causes the customer's credit maximum to be exceeded. If the maximum is exceeded, the machine can be programmed to print a signal on the margin of the form to indicate that the order requires the approval of the credit manager. In this way, only the exceptions must be reviewed manually.

Because of the huge storage capacity, it is possible to store entire price or rate tables in the machine for rapid reference. This facility allows the machine to price items or services on the basis of quantity ordered or amount used.

It is possible in many instances to store all the accounts of a business in the machine. The machine will perform all accounting functions on these records, updating them for each transaction. For example, the machine could handle inventory control and billing as its primary application, producing accounts receivable records and sales analyses at intervals. The costs of new material added to inventory could be distributed to vendor accounts, which would be referred to at intervals for the determination of accounts payable. Periodically, the machine could prepare the payroll and distribute labor costs to the proper accounts.

Advantages

Transactions are posted as they occur. This leads to the availability of more timely information and closer control over business transactions. For example, in the inventory control application just presented, receipts are immediately entered into the inventory accounts and issues are immediately extracted. The item account therefore constantly reflects the current balance of items on hand. Closer control over inventory results in reduced inventory charges and increased service to customers by reduced back orders.

Continuous in-line processing eliminates the need for transactions of a like kind to accumulate before making a run. This makes possible a continuous flow of orders through the office and warehouse, resulting in a much smoother operation and better service. The procedures made possible by the ability to store five million char-

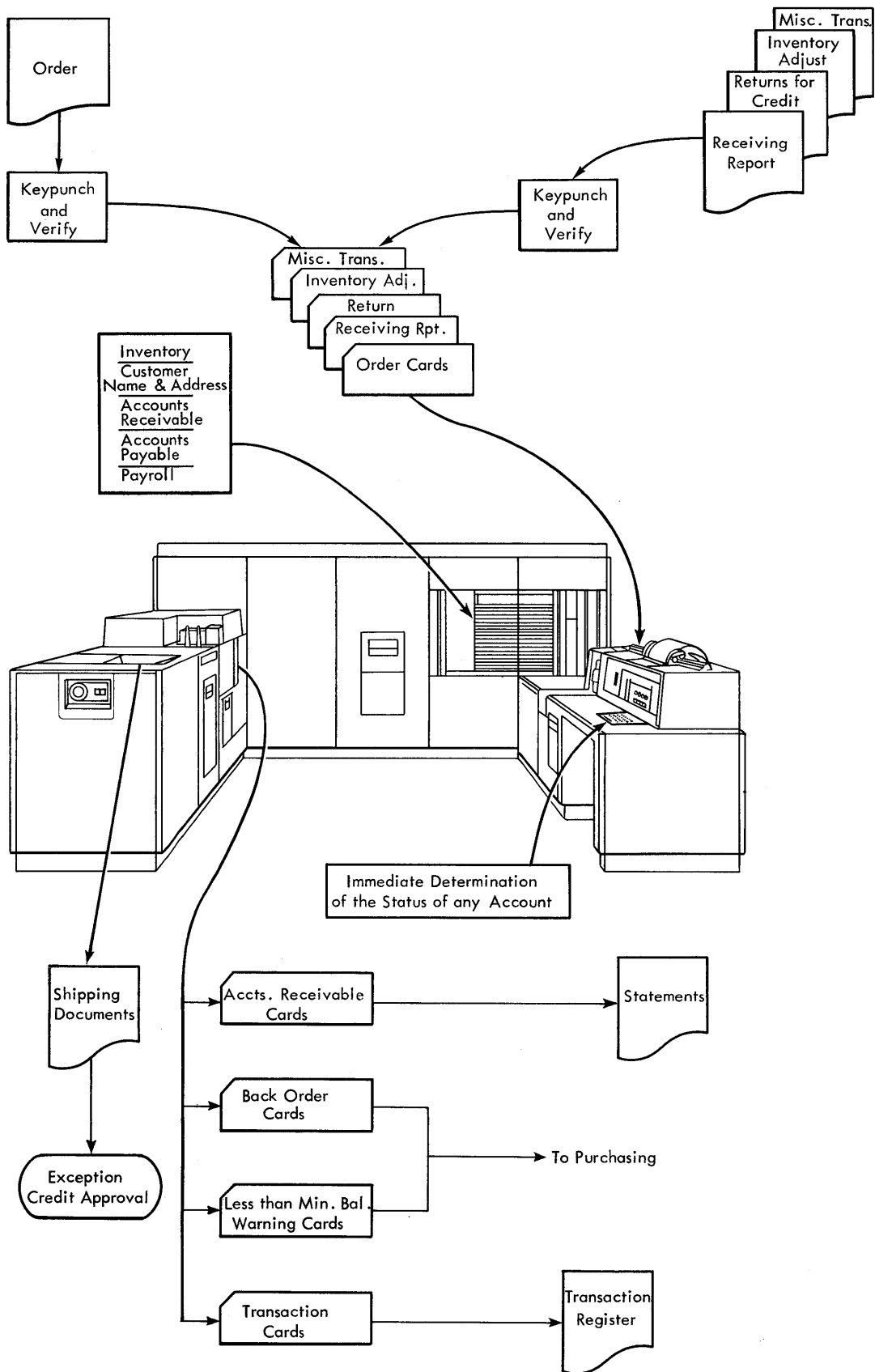

Figure 2. Flow Chart of Inventory, Billing and Accounts Receivable on RAMAC

acters of information and to obtain them from storage at a high rate of speed may eliminate the need for sorting, collating and successive runs.

Random inquiry to any part of the stored record allows a truly current balance to be obtained for any account almost instantaneously by an operator.

Current processing of minute-by-minute data means dynamic accounting instead of a history for management to review.

SYSTEM ORGANIZATION

ANY processing machine of this type has three general types of elements: input, processing and output. Raw information is fed into the machine through input units. It is processed and digested in the processing unit, and the results are obtained from the machine through the output units. These elements are present in all accounting machines.

It is usual for the processing unit to have a control section that determines the sequence of processing. An example of this type of control is the wired control panel, where the pattern of the wires determines the operations that are performed. Another type of control is the *stored program* that will be discussed later.

Figure 3 is a general diagram of the 305 system. Information is entered into the system through an input card reader. When called for by the control unit, this information enters the processing unit. Processing consists of assembling information for output documents, making logical decisions, and maintaining and updating the accounting records that are stored in the machine in the random-access storage. The results from the processing unit may be punched into IBM cards in the 323

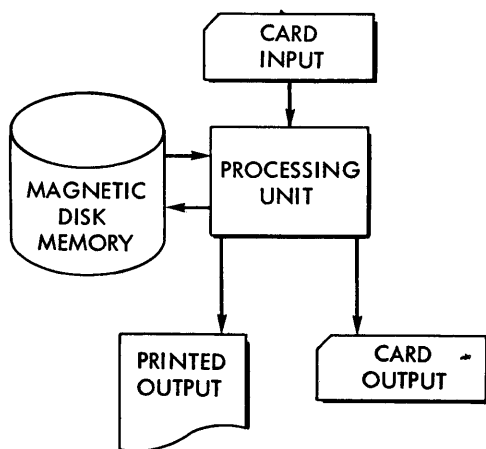

Figure 3. General Diagram of the 305 System

Punch, printed on the forms passing through the 370 Printer, typed on the 380 Typewriter, and stored in the 350 Disk Storage Unit.

Operating Speeds

The operating speeds of the machine units will be quoted when the individual units are discussed. Some of the operating times will appear slow in comparison with other electronic machines. However, it should be remembered that the 305 is an *accounting machine* with calculating ability. Most operations may be overlapped, so the actual processing time has almost no relation to the time obtained by adding up the operating times of the individual components. For example, at a given instant the machine may be printing a line on an invoice, punching a transaction card, assembling the detail of the following transaction in the processing unit, seeking a record in the random-access storage, and reading in information from a card for later processing.

To determine the time required for a given program, it will be necessary to consider not only the component speeds but also the amount of overlapping that can be obtained. This can be determined accurately only when the application has been programmed. However, an indication of the over all speed may be obtained from the programming of a number of typical applications in which the machine would completely process about 10,000 transactions in an 8-hour day. Methods of determining the exact processing time and of obtaining maximum overlapping of operations will be discussed later.

Machine Components

Processing Unit. The processing unit contains a magnetic drum, on which there are storage tracks for program instructions, arithmetic and logic, and information being processed. The processing unit also contains a 100-character magnetic-core unit, that is used for all transfers of information, and the control circuits for the processing operations.

Card Reader. In general, the information to be entered into the system is punched into IBM cards and entered through the card reader. The card reader is a parallel-type card feed containing two reading stations of 80 reading brushes each. Cards are fed face-down, 9-edge first. The feed hopper can hold up to 800 cards.

The card feed operates independently of all other input-output units. Cards are fed under the control of

the program. The maximum rate of feeding is 125 cards per minute.

As the cards pass through the reader, the 80 columns of information are read from the card, translated into the code used in the machine, and recorded on the input storage track on the magnetic drum in the processing unit.

Output Printer. The 370 Printer may be used to prepare documents while the transactions are being posted in the machine. The printer is a serial printing device that prints from a single, octagonal type stick that moves rapidly across the form from left to right. The complete alphabet, the numbers 0-9, and 11 special characters may be printed. Horizontal spacing is 10 characters per inch, and an 8-inch line (80 characters) may be printed. To print an 80-character line requires approximately two seconds. Shorter lines are printed in less time.

The information to be printed is taken from an output track on the processing drum. A control is provided on the printer to allow the character stored in any output track position to be printed in any printing position. Line program selectors are provided on the control panel to allow a number of different printing arrangements (formats) to be selected. The control panel also provides such functions as zone elimination, variable line-spacing, and special character insertion.

Tape-Controlled Carriage. A tape-controlled carriage controls the vertical movement of forms in the 370 printer. The forms tractors are adjustable horizontally to accommodate forms with a hole-to-hole width of up to 16 $\frac{1}{4}$ inches. Continuous form paper with standard marginal punching must be used. The maximum length of a form to allow proper feeding is 17 inches.

Card Punch. The 323 Card Punch is used only as an output device, and punches up to 100 cards per minute, depending on the program. The punch receives its information from the same output track that is used by the printer; it is possible to print and punch at the same time. Separate format control is provided for the punch, and by control panel wiring any 80 characters of the possible 100 characters on the output track may be punched. A complete 80-column card is punched in 600 milliseconds. It is possible to perform gangpunching, double-punch and blank-column detection, and operations involving column-splitting and character emitting.

Magnetic Disk Storage. To perform in-line processing, the machine must automatically obtain any record it requires in a minimum of time. This ability is provided by the magnetic disk storage. This unit consists of

50 metal disks, two feet in diameter, that are coated on both sides with a ferrous oxide recording material. These disks are mounted on a vertical shaft, and are slightly separated from one another. They revolve at 1200 rpm.

Information is stored in the form of magnetized spots in tracks around the disks. There are 100 concentric tracks on each disk. These tracks occupy the outer five inches of the disk surface.

At the side of the stack of disks there is an access arm that moves under electronic control to any desired track on any disk (Figure 4). Magnetic recording heads mounted on the access arm read or write information on the disks. The access arm is forked. When the fork enters the stack of disks it carries a recording head to both sides of the disk. When the arm is positioned on a disk it is possible to read or write on either side of the disk; therefore, a disk track may be thought of as existing on both the top and bottom of a disk.

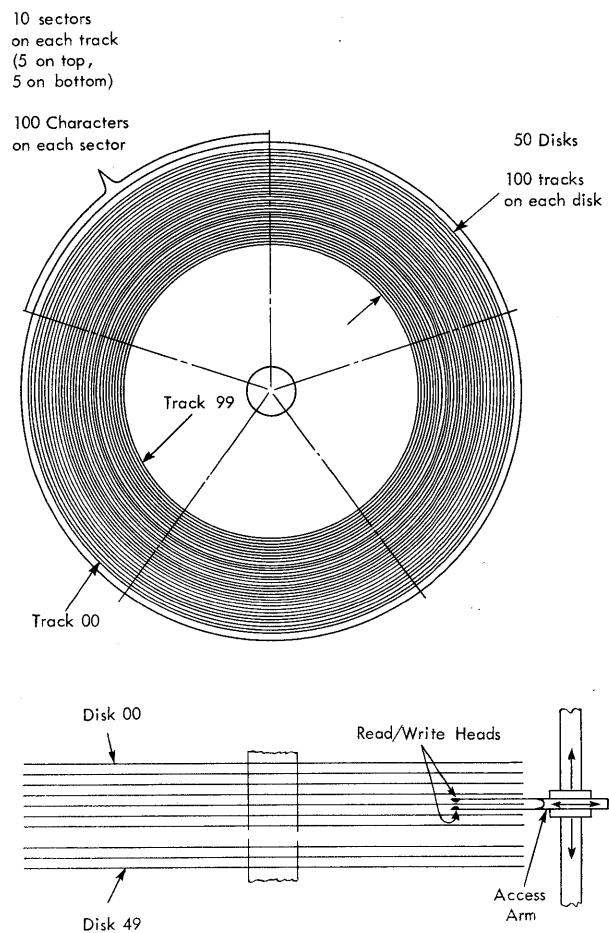

Figure 4. Schematic Disk Storage

The disk tracks are subdivided into sectors. There are ten sectors on a track; five on the top of the disk and five on the bottom. Each sector can store a 100-character accounting record. The record is stored as a series of magnetic spots recorded in the sector on the track. By storing ten 100-character records on each of 100 tracks on each of 50 disks, it is possible to store 5,000,000 alphabetic, numerical or special characters in the unit.

The magnetic disks can be used repetitively to store new information. Each time new information is stored in a sector it erases the information that was formerly stored there. Records may be read from the disks as often as desired, provided they are not written over or erased by the program.

Console. The console provides manual and semi-automatic control of the machine. The console consists of a keyboard, typewriter, signal lights and control keys. The typewriter may be used for output of inquiries from the disk storage and process drum storage, or it may be used as a supplementary printer under the control of the program. The typing speed is 10 characters per second.

Associated with the typewriter is a control panel that

establishes format control for the records that are typed on the typewriter.

The keyboard is similar to that of a typewriter. Through the use of the keyboard, inquiries for records are entered into the machine. The desired record is transferred from disk storage to the typewriter track on the processing drum. From this track, the record is typed under the format established by the typewriter control panel.

The console contains a panel of indicator lights that continually display the status of the program in the machine. This indicator panel serves as a valuable aid for checking and verifying the logic of the stored program. There are also lights that inform the operator that the machine has detected an error in the transfer of information through the system. The checking of information is discussed in a later section.

Overall Machine Schematic. The overall machine configuration and data flow through the RAMAC system is shown in Figure 5. Each component (including track addresses which are shown adjacent to the arrows and indicated on the processing drum) will be described in detail in later sections.

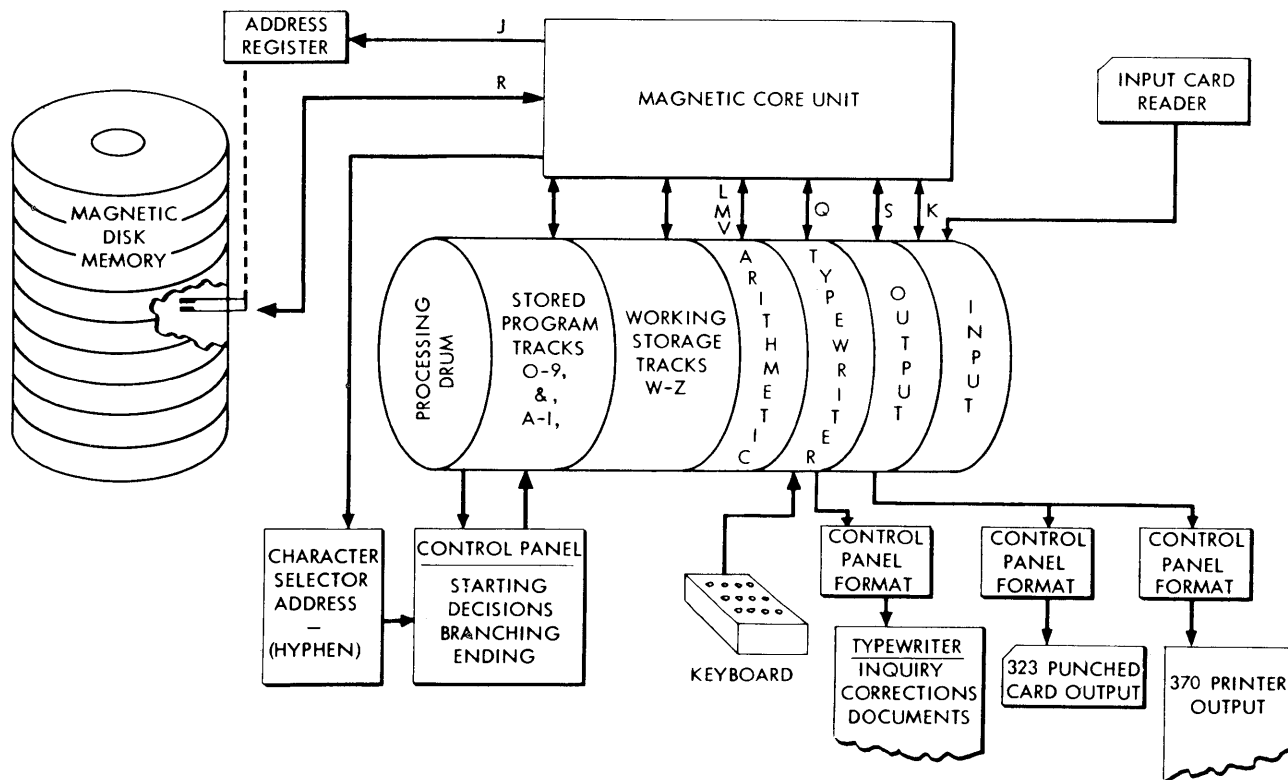

Figure 5. Summary of the 305 System

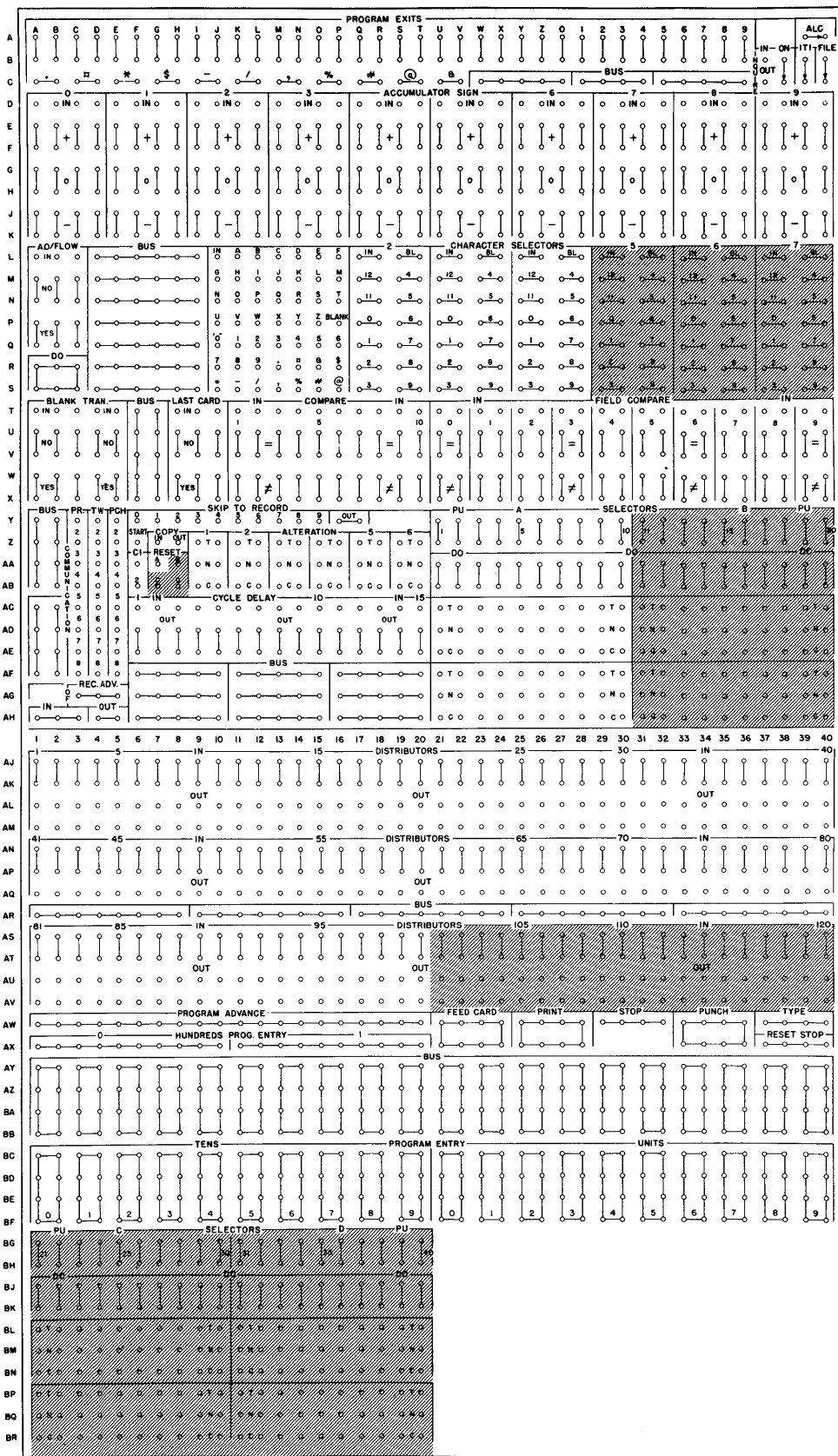

Figure 6. Process Control Panel

Programming

FOR THE GREATEST FLEXIBILITY of operation, the sequence of processing is controlled by a stored program that is modified on the basis of logical decisions made through control-panel wiring.

Stored Program

The transmission of information through the machine is controlled by a sequence of instructions called program instructions, each of which performs some basic, necessary operation. As an example, suppose the machine has stored the information that 500 gallons of white paint are in stock. An order arrives for 15 gallons of white paint. In a manual system, a stock clerk would look at the paint and decide that the order could be filled. The machine makes the same decision by arithmetic. The way the machine makes this decision may be diagrammed as follows:

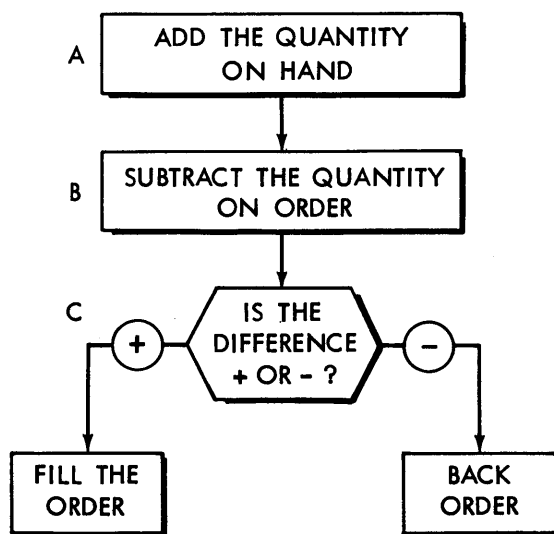

This sequence of instructions can be understood by anyone who reads English. However, the machine reads

a much more concise language called stored program coding. Instead of the English phrase, "add the quantity on hand," the machine reads a coded instruction or word something like W22L4905 that causes it to perform the required operation. The programmer can express as a series of these coded instructions all the steps that the machine must take to process the order. These program instructions are then loaded into the machine, and the machine reads the instructions and performs the sequence of operations each time an order is to be processed.

Process Control Panel

When it is necessary to make decisions, the process control panel is used. The process control panel is shown in Figure 6. To facilitate reference to specific hubs on the control panel, the rows are numbered 1 through 40 horizontally and lettered A through BR vertically. Shaded hubs indicate possible additional capacity for special features.

The decision elements, sometimes called logic elements, of the machine are arranged as selectors on the process control panel. Whenever the machine must make a decision, the control of the program may be brought to the control panel as an electrical impulse. This impulse is wired through the selectors to perform logical decisions.

For example, there are ten accumulators each of which has a sign selector arranged as shown in Figure 7. In each vertical row of hubs there is an IN hub, a pair of hubs marked +, a pair marked 0, and a pair marked -. When the accumulator is reset, or when it contains a zero balance, an internal connection is made between the IN hub and the 0 hubs. When an amount is added into the accumulator, the accumulator takes on a positive sign, and a connection is made between the IN hub and the +

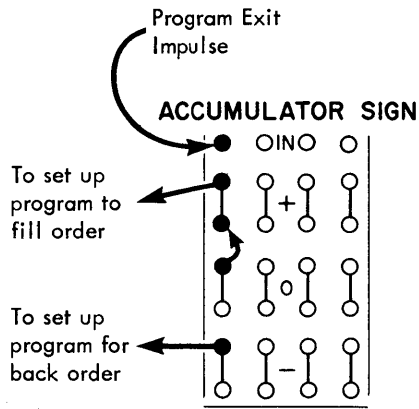

Figure 7. Method of Branching by Control Panel Wiring

hubs. When a greater negative amount is entered, the accumulator takes on a negative sign, and a connection is made between the IN hub and the - hubs. Only one of these three connections is made at any one time.

In the example previously discussed, the program would be arranged so that after the stored program step, "subtract the quantity on the order," was completed, the control would be brought to the control panel as a Program Exit impulse. This impulse would be wired to the IN hub to test the sign of the accumulator. If the accumulator were positive (50 - 15 gallons = 35 gallons) it would indicate that the order could be filled, and the test impulse, emerging from the + hub, would be wired to set up the first step of a sequence of instructions that would result in filling the order.

A zero accumulator would indicate that there is exactly enough paint to fill the order, so this hub may be connected to the + hub to cause the same program step to be set up. A negative accumulator would indicate that there is not enough paint to fill the order; so if the test impulse emerges from the - hub, it is wired to set up the first step of a sequence of instructions that causes the item to be back-ordered.

Automatic selection of machine routines in this manner is called branching. Note that the logic elements of the machine may be tested in combination, by wiring the test impulse through several selectors to set up one of a number of alternate program sequences.

Processing Drum

The processing unit contains a magnetic drum, on which the program instructions are stored. The drum also contains storage space for records being processed and updated, for input and output, and for other functions that will be described later. The drum revolves at 6000 rpm; it takes one revolution in 10 milliseconds (.010 seconds).

A number of magnetic reading and recording heads are arranged along the length of the drum. Each of these is designed to read and write magnetic spots in a narrow band around the drum. These bands are called drum tracks. Each track is divided into 100 positions, and a single character of information may be stored in each position. Figure 8 shows a graphic representation of a drum track where the track has been cut at the starting

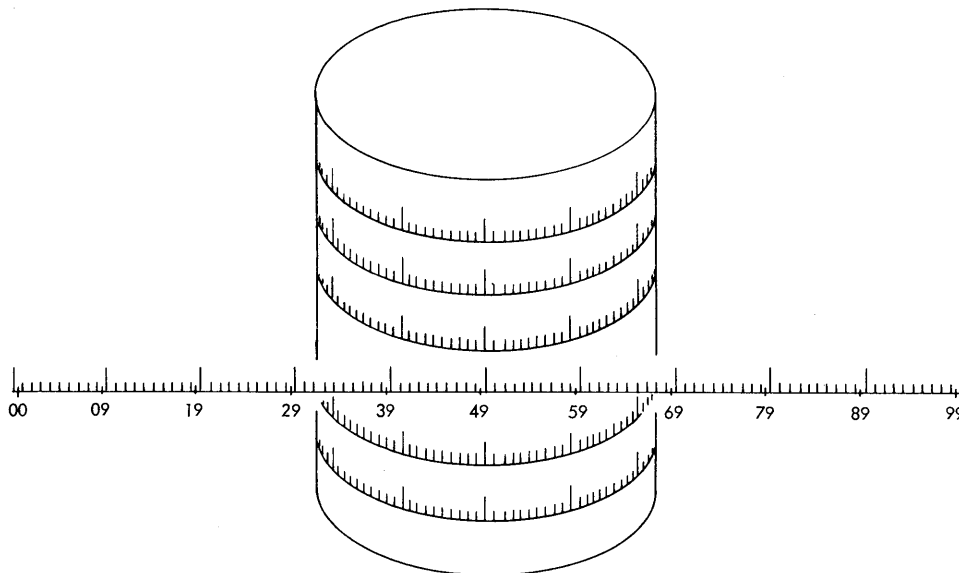

Figure 8. Graphic Representation of Drum Tracks

point and unrolled from the drum. The 100 possible recording positions have been given addresses from 00 to 99. (An address is a group of characters specifying a location in the machine.) The first character on the track is recorded in position 00; the second character is recorded at 01, etc., and the 100th character is recorded at position 99.

Each position of a track will retain its information until new information is written in that position.

PROCESSING TRACKS

Four tracks on the drum are designed specifically for the storage of information being processed. These four tracks have the addresses W, X, Y, and Z. Each of these tracks contains 100 positions with addresses which range from 00 to 99. Therefore, the address W05 locates the sixth character on process track W, and the address Z99 locates the last (100th) character on process track Z.

PROGRAM AND GENERAL STORAGE TRACKS (Figure 9)

Twenty tracks on the processing drum are arranged to store program instructions. Because each instruction

requires ten characters, ten instructions are stored on each track. Up to 200 instructions may be stored on these 20 tracks at any one time. When they are not required for the storage of program instructions, these tracks may be used as general storage tracks for the storage of other information.

The 200 instructions are given numbers between 000 and 199 to correspond with the order in which the machine executes them. After executing any instruction, the machine proceeds automatically to the next higher-numbered instruction unless it is desired to skip to some other instruction. In this way, the program may advance from step 000 to step 199. After step 199, the program returns to step 000 unless it is transferred elsewhere. The method of making these transfers is explained later.

The program tracks are given the track addresses 0, 1, 2, 3, 4, 5, 6, 7, 8, 9, &, A, B, C, D, E, F, G, H, and I. Program steps 000 to 009 are recorded on track 0, steps 010 to 019 on track 1, etc. The chart shown in Figure 9 gives the locations of all of the instructions on the program tracks.

CARD, TRACK, OR RECORD										
TRACK 0	STEP 00	01	02	03	04	05	06	07	08	09
TRACK 1	STEP 10	11	12	13	14	15	16	17	18	19
TRACK 2	STEP 20	21	22	23	24	25	26	27	28	29
TRACK 3	STEP 30	31	32	33	34	35	36	37	38	39
TRACK 4	STEP 40	41	42	43	44	45	46	47	48	49
TRACK 5	STEP 50	51	52	53	54	55	56	57	58	59
TRACK 6	STEP 60	61	62	63	64	65	66	67	68	69
TRACK 7	STEP 70	71	72	73	74	75	76	77	78	79
TRACK 8	STEP 80	81	82	83	84	85	86	87	88	89
TRACK 9	STEP 90	91	92	93	94	95	96	97	98	99
TRACK &	STEP 100	101	102	103	104	105	106	107	108	109
TRACK A	STEP 110	111	112	113	114	115	116	117	118	119
TRACK B	STEP 120	121	122	123	124	125	126	127	128	129
TRACK C	STEP 130	131	132	133	134	135	136	137	138	139
TRACK D	STEP 140	141	142	143	144	145	146	147	148	149
TRACK E	STEP 150	151	152	153	154	155	156	157	158	159
TRACK F	STEP 160	161	162	163	164	165	166	167	168	169
TRACK G	STEP 170	171	172	173	174	175	176	177	178	179
TRACK H	STEP 180	181	182	183	184	185	186	187	188	189
TRACK I	STEP 190	191	192	193	194	195	196	197	198	199

Figure 9. Location of the Instructions on the Program Tracks

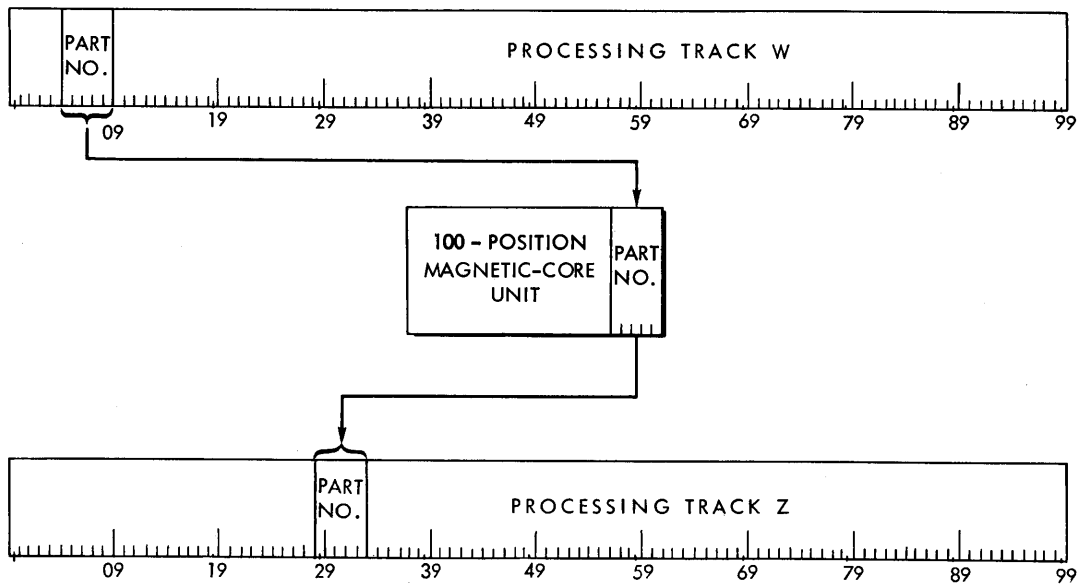

Figure 10. Schematic of a Normal Transfer Operation

Magnetic Core Unit

The stored program instructions control the flow of information through the machine much as a switchman controls the flow of trains through a railway junction. By the same analogy, the magnetic-core unit corresponds to the junction. The machine assembles information from various sources into a form that may be used for output by making a series of transfers of "pieces" of information. These transfers are accomplished by directing data through the intermediate magnetic-core unit.

This unit is arranged to store from 1 to 100 characters. Under control of the stored program, the desired information is read from a source track into the magnetic cores on one revolution of the processing drum and on the following revolution, the information is read from the cores and recorded in the specified positions of the receiving track. The cores serve as an intermediate storage unit on each transfer.

Unlike the processing drum tracks, data is transferred to the core unit starting with position 99 and extending for the number of positions being transferred. As the new information is read into the core unit, old information in those positions is erased. For example, a block of data 40 positions in length would have its units position in position 99, and its high order position in position 60. Positions 00-59 of the core unit retain their original data. As described in a later section under *Program Instruction*, the core may be addressed by the designation hyphen (-).

Program Instruction

The ten-character instructions are arranged as follows:

FROM		TO		No. Characters	Control
Track	Position	Track	Position		

The character in the first (left hand) position of the instruction specifies the track on which the desired information is stored. The next two positions specify the position of the low order character of the information on the track. These three positions are called the FROM address of the instruction. In a similar manner, the next three positions are called the TO address and specify the track and units position to which the information is being transferred. The next two positions of the instruction define how many characters (NO. CHARACTERS) are to be transferred. The ninth and tenth positions are control positions of the instruction. Any of the 47 characters recorded in the ninth position will cause an impulse to be emitted on the process control panel for testing and branching. The ninth position is also called the PROGRAM EXIT position. Specific characters recorded in the tenth position will modify the instruction for special operations such as comparing.

As an example, suppose that it is desired to transfer a part number, recorded in positions 05-09 of processing track W, into position 29-33 of process track Z. A field of five positions are read from track W into the magnetic cores, and then transferred from the cores onto track Z (Figure 10). The low-order position of track W is 09, and the low-order position of track Z is 33; therefore, the necessary program instruction is:

FROM		TO			No. Characters		Control	
Track	Position	Track	Position	Position				
W	09	Z	33	05				

A normal transfer operation in the processing unit requires 30 milliseconds (three drum revolutions) for completion. During the first 10 milliseconds, the instruction is read from the program track into an instruction register, analyzed, and used to set up the required paths for the transfer of information. This is called the *Instruction cycle*. During the second ten milliseconds, the information from the sending track is loaded into the magnetic-core unit. This is called the *From cycle*. The final 10 milliseconds are required to read out the core unit and record the contents on the receiving track. This is called the *To cycle*. In terms of the usual stored program concept, the first 10 milliseconds constitute the *instruction cycle*, and the next 20 milliseconds are the *execute cycle*. If there is no control code in the ninth position of the instruction, the machine immediately reads the next instruction, and the sequence is repeated.

Note that each transfer passes through the core unit with the units position of the transferred data in the units position of the core unit (position 99). Each position of the magnetic-core unit retains the last character transferred until a new character passes through that position. Data in the cores may be transferred by using a FROM address of -99 (other than hyphen 99 will cause incorrect operation).

Control Codes

If a control code is added to a program step in the ninth position, an additional 20 milliseconds is added to the 30 just described. During this 20 milliseconds, the control is brought to the control panel as an electrical impulse, which is used to test the logic elements and perform other functions. The additional 20 milliseconds

are required for the machine to step through two additional cycles, a 10-millisecond *delay* and a 10-millisecond *exit* cycle.

The ninth position control code may be any letter, number or special character. When a control code is added to an instruction (in the ninth character of the instruction), after the instruction has been performed an impulse is emitted from the correspondingly-marked hub on the process control panel. The control codes may be used in any order.

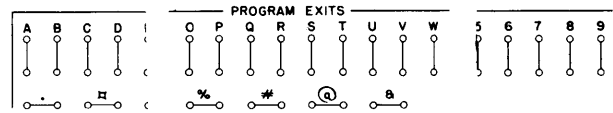

A-B, 1-36
C, 1-22

Program Exits. When a control code is placed in the ninth position of an instruction, an electrical impulse is emitted from the correspondingly marked PROGRAM EXIT hubs. Simultaneously, the program sequence is halted. The impulse is used to test the logic elements on the control panel, and a new sequence of instructions must be initiated by the impulse on the basis of their setting. The new sequence is established by wiring the impulse to the desired PROGRAM ENTRY hubs.

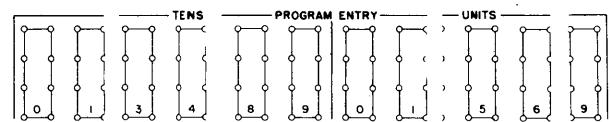

BC-BF, 1-40



AW, 1-20
AX, 1-20

Program Entry. These hubs accept a Program Exit impulse to set up the first step of a new sequence. Unless a new sequence is started in this manner, or by impulsing PROGRAM ADVANCE, programming will stop with the DELAY and EXIT lights at the console on.

The new stored program step is set up by impulsing a TENS hub and a UNITS hub that corresponds to the number of the desired program step, provided that the step is in the same hundred steps (000-099 or 100-

199) as the step that caused the program exit. For example, to transfer the stored program from step 32 to step 68, the instruction for step 32 would have a control code added, giving the instruction the form:

FROM			TO			No. Characters	Control	
Track	Position		Track	Position				
W	1	5	M	2	9	0	2	B

When the instruction is completed, an impulse is emitted from the PROGRAM EXIT B hub, and the program sequence is halted. The impulse would be wired (through distributors) to the PROGRAM ENTRY hubs, impulsing TENS hub 6 and UNITS hub 8. This sets up step 68 as the next step. The TENS and UNITS hub must be impulsed simultaneously.

If the program is to be skipped to step 168, it would also be necessary to impulse simultaneously the HUNDREDS PROGRAM ENTRY 1 hubs. Similarly, to skip the program from step 132 to step 68, the impulse emitted as a result of the control code on step 132 would be wired to impulse the HUNDREDS hub 0, the TENS hub 6 and the UNITS hub 8. It is not necessary to impulse the HUNDREDS PROGRAM ENTRY when the program remains within the same hundred program steps. Figure 11 shows how these transfers are wired on the control panel.

Program Advance. When the program sequence is halted by the presence of a control code in the ninth position of an instruction, it is frequently desirable to return to the next program step. If the PROGRAM ADVANCE hubs are impulsed instead of PROGRAM ENTRY, the stored program resumes control on the next program step. Figure 11 shows wiring in which the control code K tells the machine to print the record stored on the output track and advance to the next program step.

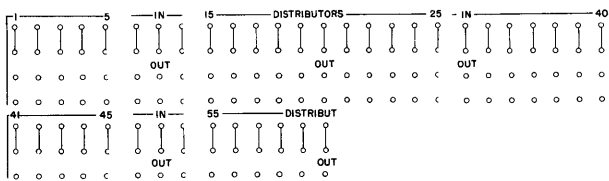

AJ-AM, 1-40
AN-AQ, 1-20

Distributors. Impulses that are used to perform several functions are wired through distributors, which serve the same function as split wires, but prevent possible back circuits. The impulse wired to the IN hub of a distributor is available at the associated OUT hubs, but impulses cannot travel between OUT hubs, or from an OUT hub to the IN hub. Any impulse except that from the OUT hub of another distributor may be wired through a distributor. Whenever an impulse is directed to more than one function, it should be wired through a distributor.

Input Track

Cards fed into the card reader are recorded on the input track in positions 00-79. Positions 80-99 are written as blanks. When the input has been checked, the data on the input track may be processed. The input track has the address K. This track is addressed in the same manner as the other storage tracks, for transfers under stored program control. Thus, to transfer the entire input track to the processing track Y, the instruction is:

FROM			TO			No. Characters	Control	
Track	Position		Track	Position				
K	9	9	Y	9	9	0	0	

NOTE: A NO CHARACTERS of 00 denotes 100 characters.

To transfer the first 50 positions of the input track to the last 50 positions of program track 9, the instruction is:

FROM			TO			No. Characters	Control	
Track	Position		Track	Position				
K	4	9	9	9	9	5	0	

NOTE: The instruction just shown indicates that the input track may be used as a processing track, because it is possible to transfer part of the track without taking the entire 100 characters. However, when the input track is used in this manner it is not possible to feed the next card until the use of the input track has been com-

pleted. Usually the entire input track is transferred to another processing track, and the feeding of another card is started while the first card is being processed. In this way, the time required to read the next card is overlapped by the processing of the preceding card.

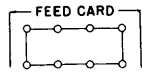

AW-AX, 21-24

Feed Card. Impulsing these hubs causes the card reader to feed a card past each station. The card passing first reading is automatically coded and recorded on one input track. This recording is later transferred to another input track so that the recording may be compared against the reading of that same card as it passes second reading. If the two recordings compare (identical), the input track data may be processed. (See *Internal Checking. Read Check.*)

Output Track

The output track has the address S. When information is transferred to the output track, it may be printed on the 370 Printer or punched into IBM cards in the 323 Card Punch or both. Format control on these units determines the arrangement of the printing or punching.

The instruction to transfer the entire processing track Z to the output track is:

FROM		TO		No. Characters	Control
Track	Position	Track	Position		
Z	9 9	S	9 9	0 0	

The instruction to transfer the first 32 positions of processing track Y to the last 32 positions of the output track is:

FROM		TO		No. Characters	Control
Track	Position	Track	Position		
Y	3 1	S	9 9	3 2	

NOTE: This instruction indicates that the output track may be used as a processing track, because it is possible to assemble records on the output track. However, some loss of time may occur, because the output track cannot be altered while printing or punching is in progress. This facility is mentioned here because it may be of value when, due to a very involved program, all program and processing tracks are required for other storage. It is possible to read *from* the output track while printing or punching is taking place, but writing must wait until the track is *released* after printing or punching is completed.

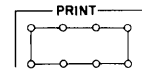

AW-AX, 25-28

Print. Impulsing these hubs causes the printer to print from the output track. The arrangement of the printing is determined by the printer control panel. The rearrangement of data as it passes through the control panel from the machine to a printed or punched document is called *format control*. If two or more successive impulses are directed to the Print hub without an intervening transfer to the output track, the second line will not print if the first line has not been completed at the time of the second print impulse.

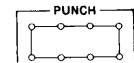

AW-AX, 33-36

Punch. Impulsing these hubs causes the output punch to punch from the output track. Format control on the punch allows control of the columns that are being punched.

Typewriter Output

The typewriter may be programmed to type out instructions to the operator or signals that unusual conditions have been encountered. For example, the typewriter may type out records that are out of stock or have fallen below minimum balance. It may also print out legends such as "item record not in memory."

To cause the typewriter to operate from the program, the program instruction transfers the desired output



Figure 13. Program Load Button

The Program Load button (Figure 13) is used to feed Program Load cards into RAMAC. When the first card has passed the second reading stations and all input

checking has been satisfied, an automatic transfer occurs which moves the input data to the I track (an automatic K99I9900).

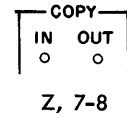

As soon as this transfer has been completed, an impulse is available (30 milliseconds later) from the COPY OUT hub on the Process Control Panel which is wired to feed a new card, and programming is directed to step 190 (track I, Figure 14). Step 190 will contain the same instruction that was in columns 1-10 of the input card. This instruction will cause the five steps on track I in position 30-79 to be transferred to the proper program

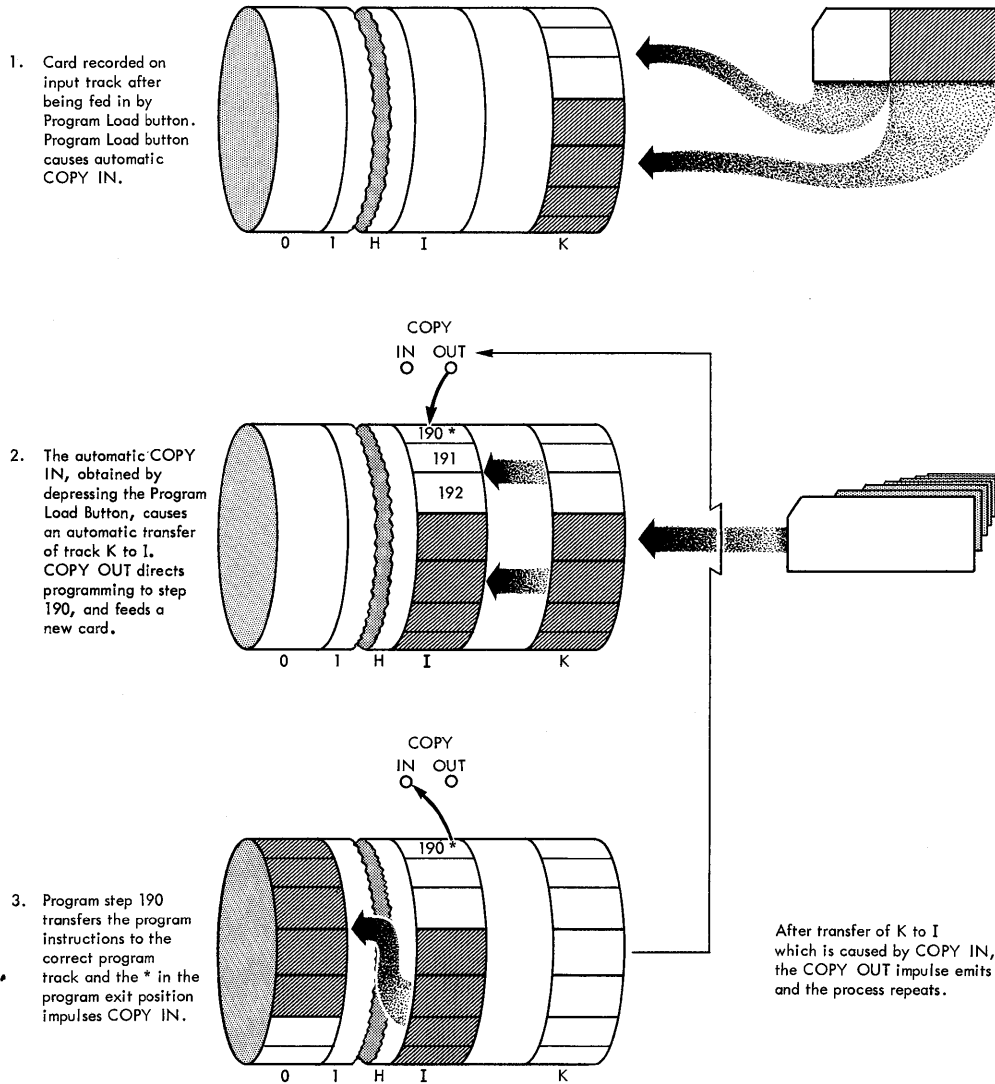

Figure 14. Program Loading

track. For example, if the card contained instructions 00-04, step 190 would be:

FROM			TO			No. Characters	Control
Track	Position		Track	Position			
I	7	9	0	4	9	50	*

This instruction would transfer 50 characters from track I to track 0.

Instruction 190 also contains an * in the ninth position. This program exit is wired to COPY IN. The COPY IN hub has the same function as the Program Load button and when impulsed, causes an automatic transfer from track K to I after the first card. By impulsing COPY IN, the next card is transferred to track I and the routine repeats itself.

It is usually desirable to type out a listing of the instructions as they are loaded to verify the load routine. In order to accomplish this, the * is deleted from the instruction in column 1-10 of the second card. After instruction 190 has been executed, the program advances to step 191 which corresponds to columns 11-20. This instruction transfers the assembled program from the program track to the typewriter track and a program exit of "&" causes a TYPE and COPY IN (099Q9900&).

The following sequence is then established:

1. The first card assembles five instructions in the first five instruction positions of program track 0.
2. The next card assembles the remaining five instructions on track 0, and then transfers all ten instructions from 0 to the Q track so that they can be typed out on the Console typewriter.
3. Subsequent cards load program instructions onto track 1-9, &, A-I, and, as these tracks are com-

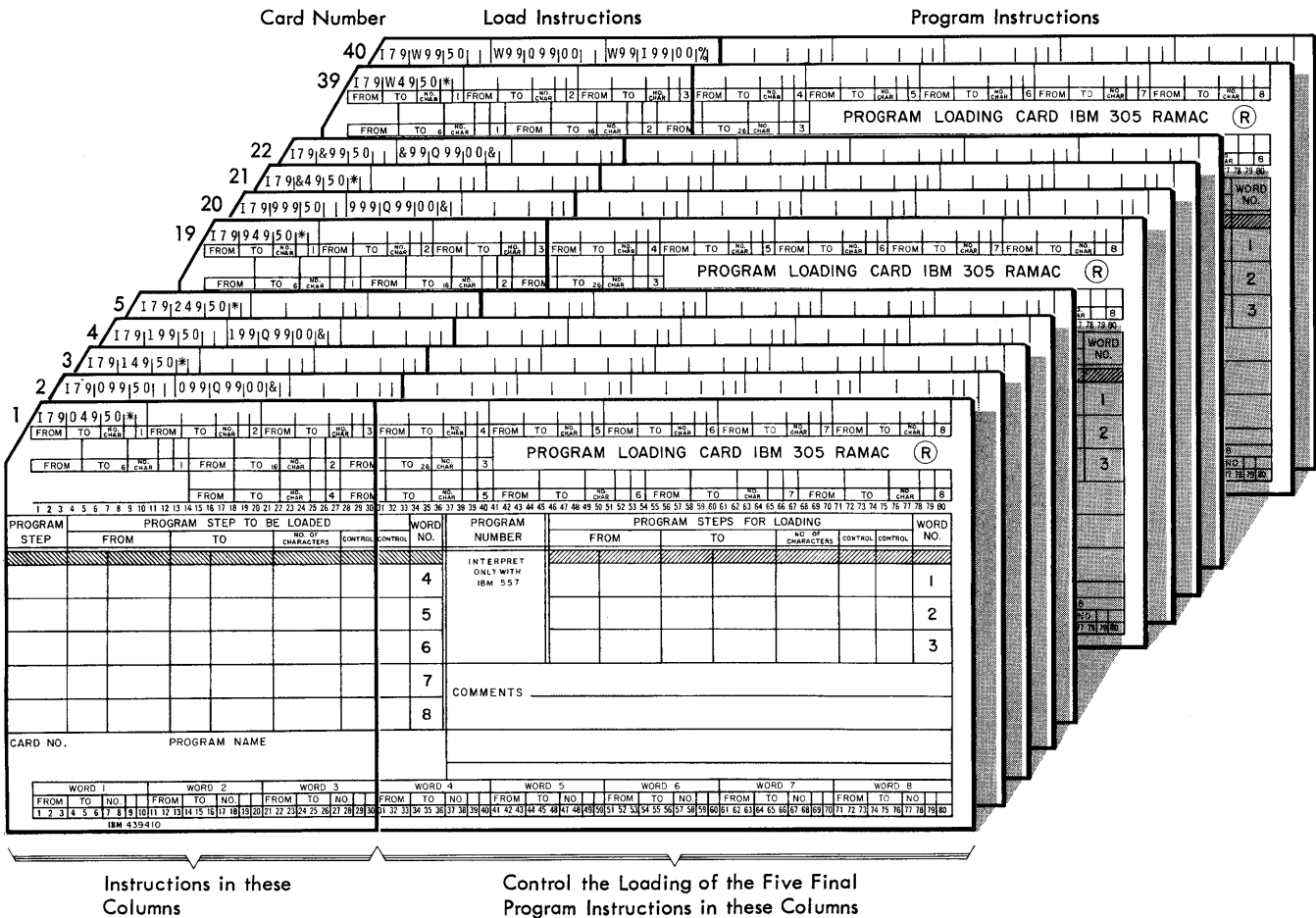
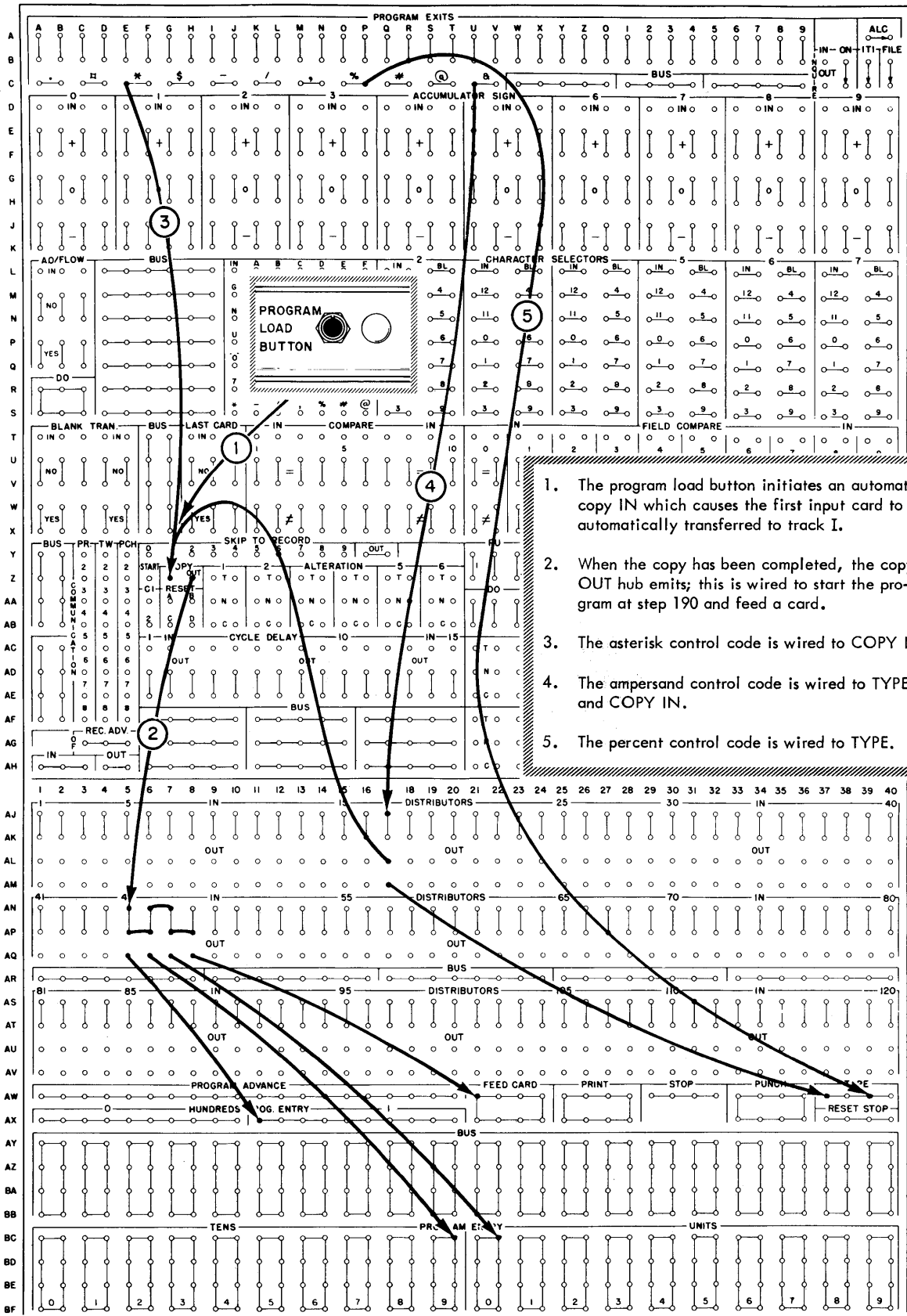

Figure 15. Program Instructions for Loading the Program



1. The program load button initiates an automatic copy IN which causes the first input card to be automatically transferred to track I.
2. When the copy has been completed, the copy OUT hub emits; this is wired to start the program at step 190 and feed a card.
3. The asterisk control code is wired to COPY IN.
4. The ampersand control code is wired to TYPE and COPY IN.
5. The percent control code is wired to TYPE.

Figure 16. Control Panel Wiring for Loading the Program

pleted, they are typed out to prove that the program is loaded correctly.

Figure 15 shows the load card arrangement. Every other card transfers the assembled instructions from the program track for typing.

To load the full 200 program steps, cards 39 and 40 (Figure 15) assemble steps 190-199 on processing track W. On step 191, track W is transferred to the typewriter track (Q), and on step 192 track W is transferred to track I, erasing the control instructions. The control code “%” on the last step brings the control to the control panel, where it is wired to type the last 10 instructions, but because no new program step is initiated by impulsing Program Entries, the machine will stop after this instruction. The necessary control panel wiring for program loading is shown in Figure 16.

Disk Storage

Two steps are required to read or write information in disk storage. First, the access arm must be moved from wherever it happens to be standing to the disk, track and sector that contains the desired record. When the access arm reaches the record, the record must be transferred through the magnetic-core unit to the process drum if the record is to be read, or from the process drum to the disk if the record is to be written in the disk storage (Figure 17).

ADDRESSING

Records stored in disk storage are located through an associated 5-position address register, that may be

thought of as a “phone number” for the information. The 5-position address is arranged thus:

DISK NUMBER		TRACK NUMBER		REC. NO.
0	0	0	0	0
4	9	to 9	9	9

The two high-order digits specify which of the 50 disks is to be used. The disks are numbered from top to bottom with the addresses 00 to 49. The next two digits specify which of the 100 tracks on the disk is desired. The tracks are numbered 00-99 from the outside in. These four digits are used to position the access arm.

Because the arm is forked, when it is positioned on a disk and track it can read any of the ten records (five on the bottom and five on the top of the disk) that may be stored on the track. The low order digit of the address specifies which one of the 10 sectors available at that physical location is to be used. The sectors are numbered 0-4 on the top of the disk and 5-9 on the bottom. This addressing arrangement provides 50,000 sectors having addresses from 00000 to 49999. Thus, the address 12345 causes the access arm to move to disk number 12, track number 34, and read out record number 5. Transmission of the address to the address register initiates the movement of the access arm.

The address register has the address “J” in the stored program coding structure. To move the access arm to a desired record, the address of the record is transferred to

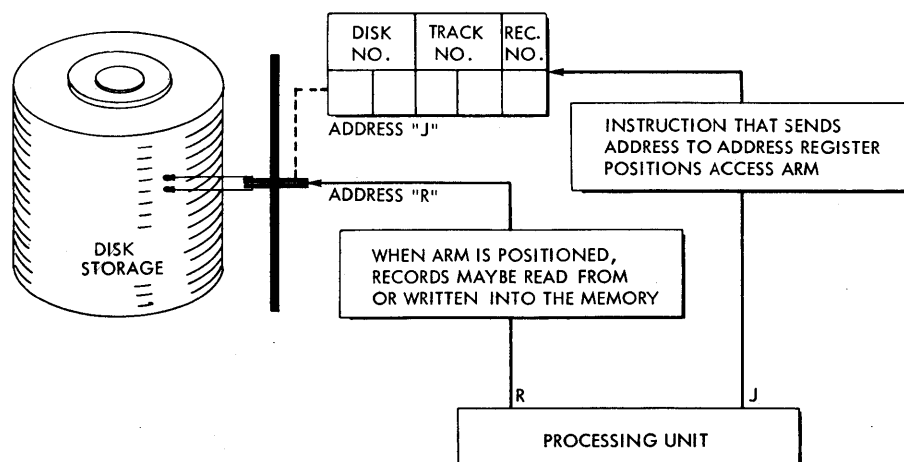

Figure 17. Method of Addressing, Reading and Writing in Disk Storage

the address register. For example, if the address of the desired record is recorded on the first five positions of process track W, the instruction to move the access arm to that record is:

FROM		TO		No. Characters	Control
Track	Position	Track	Position		
W	0 4	J	9 9	0 5	

This instruction transmits the address of the desired record (sector) to the address register and causes the arm to start moving toward the disk, track, and sector specified by the address. This instruction which is called a "seek" instruction requires 50 milliseconds. If a program exit is added to the seek instruction, the time required to execute the instruction remains the same—50 milliseconds.

Addresses J95 through J99 will address the corresponding positions of the address register. Addresses less than J95 will cause incorrect machine operation.

If less than five characters are transferred, all positions except those receiving digits will be set to zero. For instance, an instruction:

FROM		TO		No. Characters	Control
Track	Position	Track	Position		
A	0 4	J	9 8	0 2	

will cause an address register configuration of:

Disk	Track	Rec.
00	XX	0

If the high order position receives a digit over 4, a 5 is automatically subtracted from this position. The zone portion of alphabetic characters are ignored and the characters are recognized as numerical digits 1 through 9 in all address positions. Special characters are treated as follows:

&&&&&	appear as	00000
-----		00000
//////		11111
□□□□□		48888
%%%%%%%%%		48888
*****		48888
@@@@@@		48888
#####		49999
\$\$\$\$\$		49999
,, , , ,		49999
.....		49999

The access arm will seek the same location whether the address is sent to the address register by the program, or by an inquiry from the Console Keyboard. Alphabetic and special characters are decoded in the same manner in both cases.

An instruction of R to J is invalid and will cause a machine stop.

READ FROM AND TO DISK STORAGE

When the access arm has moved to the desired address, the record may be transferred to any other track by the address "R99." To transfer the record to the X processing track, the instruction would be:

FROM		TO		No. Characters	Control
Track	Position	Track	Position		
R	9 9	X	9 9	0 0	

If it is desired to transfer a record from the processing unit to the sector, the instruction is:

FROM		TO		No. Characters	Control
Track	Position	Track	Position		
X	9 9	R	9 9	0 0	

When transferring information to or from disk storage, the machine automatically transfers 100 positions of data between the magnetic core unit and the file.

Consequently, all file transfer instructions should contain R99 and call for 100 characters of information to be transferred.

An instruction which calls for less than 100 characters of information to be transferred *to* the file will transfer the specified number of positions to the magnetic-core unit (with the units position of the field being transferred aligning with position 99 of the core); however, the entire contents of the core unit will automatically be read to the file record.

An instruction calling for less than 100 positions to be transferred *from* the file will transfer the entire contents of the record to the core unit, then the specified number of positions will transfer from the core unit to the drum track. The transfer from the core will, however, begin with position 99 of the cores.

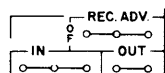

AG, 4-5
AH, 1-5

Record Advance. When successive records on the same magnetic-disk track are desired, it is not necessary to move the access arm physically. The number in the address register may be advanced, one address at a time, by control-panel wiring. A program exit is wired into the Record Advance IN hubs to increase the units position of the number in the address register by 1. When this operation is completed, an impulse is emitted from the OUT hubs; it is wired to set up the next program step. If the arm has previously been sent to address 12345, impulsing the IN hub will advance the address register to 12346. Successive impulses will set 12347, 12348, 12349, 12340, 12341, 12342, etc., in the address register. This makes it possible to obtain records that are spread over several sectors without the necessity of sending a new address to the address register.

When the record is advanced from 9 to 0, an impulse is emitted from the OVERFLOW hub instead of the OUT hub. This provides a control for branching to a record on another track by programming a new seek.

Note that this operation only affects the low-order position of the address register and does not carry over into the other positions. To do so requires the relocation of the access arm; this is accomplished only by transmitting an address to the address register.

When a program exit impulsed Record Advance IN, an additional 30 milliseconds is added to the 50 millisecond instruction. These 30 milliseconds are divided into two 10 millisecond *delay* cycles and a 10 millisecond *exit* cycle during which the Record Advance OUT or OVERFLOW hubs emit.

Comparing

A comparing unit is provided to allow fields from various tracks to be compared for control purposes. Comparing is controlled by placing the character "1" in the tenth position of an instruction. For example, to compare positions 00-04 of track W with positions 05-09 of track Z, the instruction

FROM		TO		No. Characters	Control
Track	Position	Track	Position		
W	0 4	Z	0 9	0 5	A 1

does not transfer information from track W to track Z, but causes the two fields W00-04 and Z05-09 to be compared. The program exit "A" causes the control to emerge on the control panel as an electrical impulse to test the compare selector. The test does not have to be on the same instruction. The compare selectors retain their setting until the next compare instruction.

On a compare instruction, during the first 10 milliseconds the instruction is read from the program track and used to set up the required paths (Figure 18). During the second 10 milliseconds, the field specified by the FROM address is read from the track into the magnetic-core unit. During the third 10 milliseconds, instead of being written on the track specified by the TO address the contents of the magnetic-core unit are sent to the comparing unit. Simultaneously, the contents of the TO address are sent to the comparing unit. The FROM and TO fields are compared bit-by-bit, character-by-character and *any* difference in the two fields of characters will be recognized as an unequal condition. If the two fields contain exactly the same characters, an equal condition will be indicated.

The disk file (R99), core unit (-99), or the accumulator track (L or M) must always be the FROM address on a compare operation. If these addresses are used as the TO address during a compare operation, incorrect results will be obtained. The multiplicand track (V99) can be used as the TO address only if the NO. CHAR-

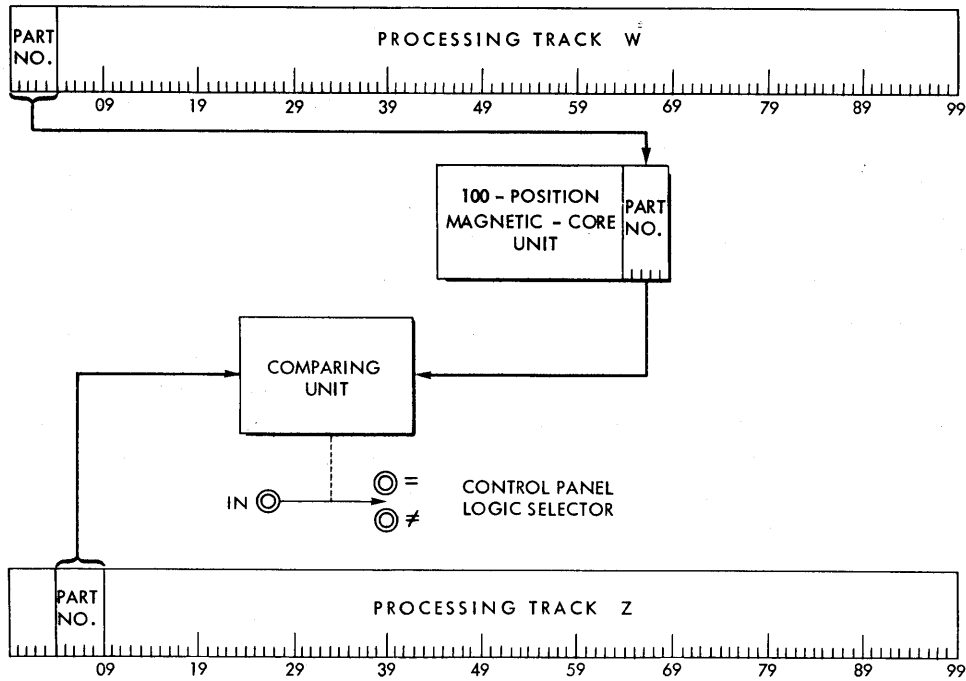
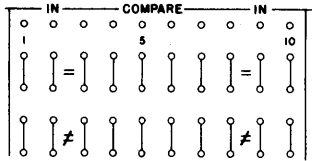

Figure 18. Schematic of a Comparing Operation

ACTERS positions of the instruction specifies 100 characters.



T-X, 11-20

Compare. When two fields are compared, this selector is set to indicate the result of the comparison test. If the fields are equal, an internal path is set up between each IN hub and the = (equal) hub beneath it. If the field fails to compare, a connection is made between each IN hub and the ≠ (not equal) hub beneath it. A PROGRAM EXIT impulse wired into the IN hub will emerge from the equal hub if the fields compare, but it will emerge from the not-equal hub if the fields fail to compare. The internal path remains set up until the next programmed compare instruction.

Field Compare

The field compare feature allows, with one instruction, from one to ten fields on the track specified by the FROM address to be individually compared with the fields of a track specified by the TO address.

Field comparing is controlled by placing the character 2 in the tenth position of an instruction. When this control character is read, the characters specified by the TO address are sent to the comparing unit, where they are compared bit-by-bit and character-by-character from right to left with the characters specified by the FROM address. The results of this comparison will be indicated in the ten selectors associated with the field compare device.

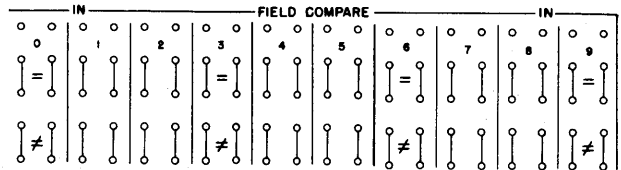

T-X, 21-40

Each selector indicates an equal or unequal condition, depending on the results of comparison of the characters in a specific 10-position field at the TO address. Selector 0 is always controlled by positions 00-09 at the TO address; selector 1 by positions 10-19; selector 2 by positions 20-29, etc. When a comparison is made involving any or all of the characters in one of these 10-position fields at the TO address, the corresponding selector is activated.

For example, the instruction

FROM		TO		No. Characters	Control
Track	Position	Track	Position		
B	4 6	C	6 3	1 5	2

causes the 15 characters on track B positions 32-46 to be compared to the 15 characters on track C positions 49-63. Three field compare selectors register the results of the comparison (Figure 19). Selector 4 indicates the result of the comparison of the single digit at B 32 with the single digit at C 49; selector 5 indicates the result of the comparison of B 33-42 with C 50-59; and selector 6 indicates the result of the comparison of B 43-46 with C 60-63.

A maximum of 100 characters, divided into ten 10-position fields, may be compared on one step. When fewer than 100 characters are to be compared, the fields at the FROM address may appear in any adjacent positions on the track. In general, the fields at the TO location should be set up in adjacent 10-position segments of the track which correspond to the 10-position fields controlling the comparison selectors.

The machine sequence for field compare is as follows:

1. Any Program Exit cycle (EXIT cycle) will prepare (condition) all ten selectors to restore to an equal setting. The selectors are not restored at this time, however.
2. Then, during the INSTRUCTION cycle of the next field compare instruction, all ten selectors are restored to equal. The selectors affected by the compare are then set to unequal where applicable during the TO cycle of the compare instruction. Once a field compare selector is set to unequal, it cannot be restored to an equal condition until a program exit conditions all ten selectors for restoring, and a field compare instruction is initiated.

If it is necessary to set each field compare selector individually (for example, when fields do not align properly), extreme caution must be exercised. The several individual field compare instructions must not be interrupted by an instruction which contains a Program Exit, because this instruction will condition any selectors which had been previously set to be restored on the following field compare instruction.

A problem may arise during restart procedures (error correction procedures) because any track read or write, Check Reset or Program Set operation (see *Console Operating Procedures*) will have the same effect on the field compare selectors as a Program Exit cycle. If a restart

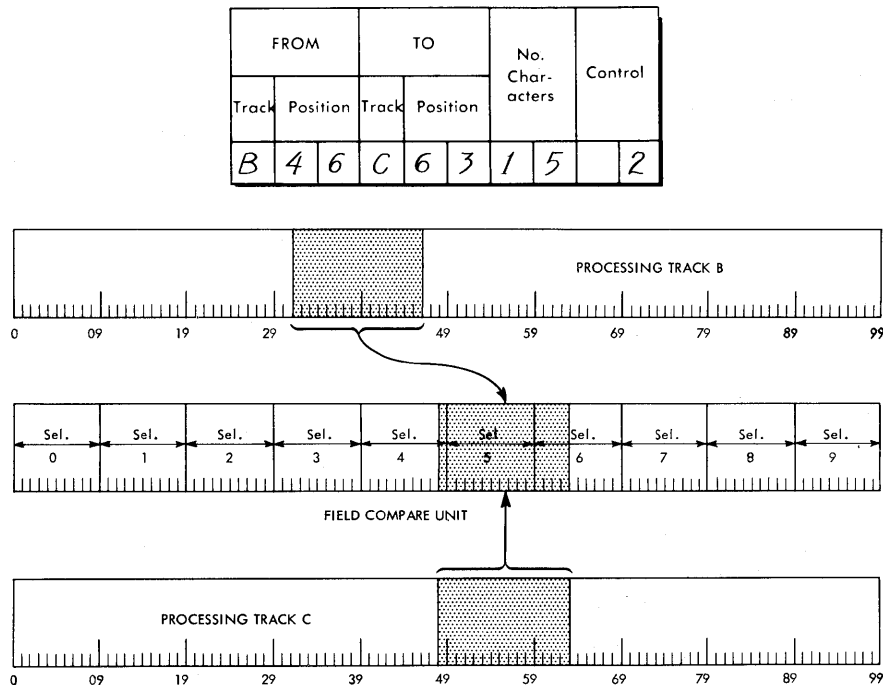

Figure 19. Schematic of a Field Compare Operation

condition arises during a sequence of field compare instructions, the program must be restarted on the first of the field compare instructions.

The FROM address of a field compare instruction may refer to a process drum track, a disk record, or the Magnetic-Core unit. The core unit (-99), or the disk file (R99), and the accumulator track (L-M) may not be used as a TO address.

When the multiplicand track is to be used as the TO address, V99 should be used and the NO. CHARACTERS must be a multiple of 10. Furthermore, when the field comparison is made, the machine automatically compares the entire contents (100 positions) of the core unit with the multiplicand track. If the NO. CHARACTERS is less than 100, only the high order field compare selectors (9, 8, 7, etc.) will indicate a true comparison. This occurs because the units position of the drum track field that is being compared aligns with position 99 of the core unit. For example, the instruction W69V9930h2 would indicate a true setting only in selectors 9, 8, and 7. Selectors 0-6 would indicate the results of a comparison made between data previously contained in core positions 00-69 and multiplicand track positions 00-69. Field compare selectors should not be set up in sequence if one of the instructions in the sequence uses V99 as a TO address because all field compare selectors are affected.

Combined Compare — Code 3

If a 3 is placed in the tenth position of an instruction, both compare and field compare are activated. For example, with the instruction

FROM			TO			No. Characters	Control
Track	Position		Track	Position			
A	1	9	B	4	9	20	A 3

both the compare selectors and the field compare selectors are set up. The control code A may then be wired to test both comparing devices. The field compare unit would register the results of the comparison in selectors three and four, and the other compare unit would register the results of the entire 20-digit comparison.

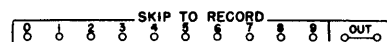

Y, 6-17

Skip-to-Record. The record skip feature is arranged with ten SKIP-TO hubs (0-9) and two common OUT hubs. When one of the numbered hubs is impulsed, the access arm remains on the same disk and track, but the disk address register is advanced so that the units position of the disk address (sector) corresponds to the number of the hub impulsed.

After the corresponding address has been set up in the address register, the OUT hub emits. This impulse is used in the same manner as a Program Exit impulse to transfer the program to any desired step, and it must be used to restart the program. The major use for this feature will be in conjunction with the field compare unit when indexing techniques are used to locate a particular record. Indexing is explained in a later section under *Disk Storage Organization*. Figure 20 illustrates Field Compare and Skip-To-Record.

The timing of the Skip-To-Record operation is the same as Record Advance. An additional 30 milliseconds is added to the 50 millisecond instruction to allow the OUT impulse to advance programming. These 30 milliseconds are divided into two 10-millisecond delay cycles and a 10-millisecond SKIP TO OUT impulse cycle.

ARITHMETIC OPERATIONS

ARITHMETIC operations such as add, subtract, multiply and divide are discussed in this section.

Accumulators

One track on the magnetic drum in the processing unit is designed for accumulation. The track is divided into ten sections of ten positions each. Each of these sections is a separate accumulator. The positions of the accumulators are addressed in the same manner as the positions of any other track. The layout of the accumulator track is shown in Figure 21.

The maximum size field that may be entered into one accumulator is ten digits. It is not possible to couple the accumulators on the control panel in order to obtain one accumulator with a capacity greater than 10 positions. If an accumulated amount exceeds the 10 positions of the accumulator, the Accumulator Overflow Selector is trans-

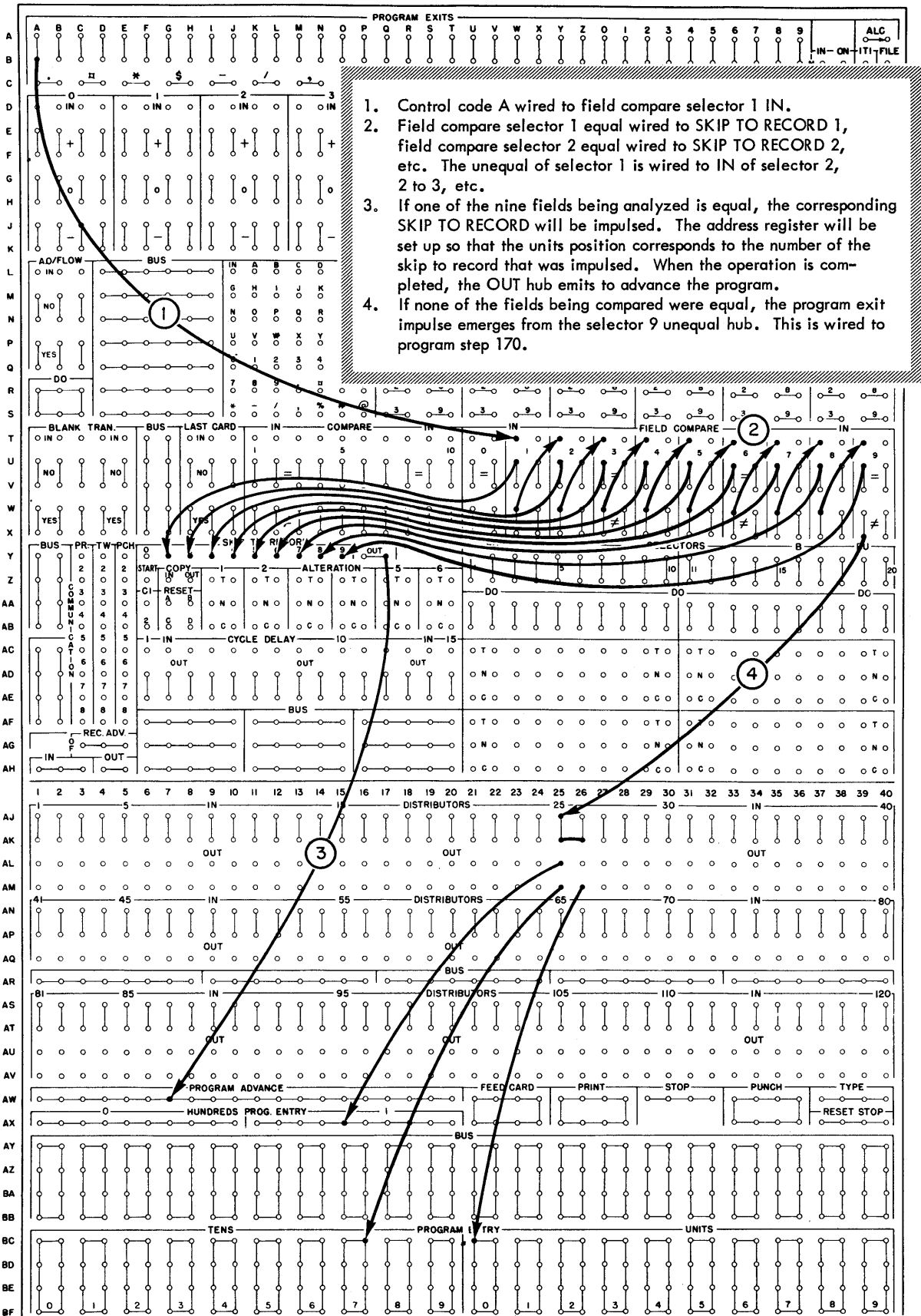

Figure 20. Field Compare and Skip-To-Record

ferred on the control panel and the Accumulator Overflow light at the 380 Console is turned on. Depending on the wishes of the programmer, the machine may be caused to stop, or branch to a routine that takes account of the overflow.

Two or more adjacent fields of information may be entered into a similar number of adjacent accumulators on one program step. Normally, the low-order positions of the succeeding fields must be separated by ten positions to agree with the low-order positions of the accumulators.

The accumulator track is addressed by the stored program characters L and M as follows:

	FROM TRACK	TO TRACK
Accumulator add		L
Accumulator subtract		M
Accumulator read out	L	
Read out and reset	M	

Examples: To add the six-digit number located in positions 54-59 of track W into accumulator 2, the instruction is:

FROM		TO		No. Characters	Control
Track	Position	Track	Position		
W	5 9	L	2 9	0 6	

To subtract the three-digit number located in positions 13-15 of track X into the same accumulator, but shifted to the left two places, the instruction is:

FROM		TO		No. Characters	Control
Track	Position	Track	Position		
X	1 5	M	2 7	0 3	

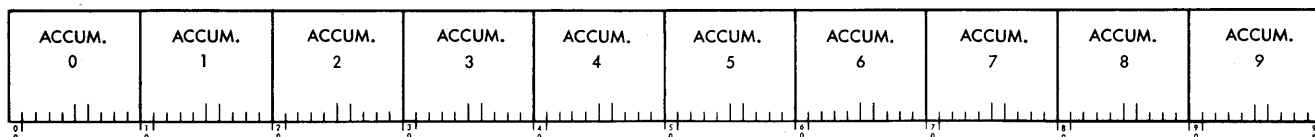

Figure 21. Layout of the Accumulator Track

This arrangement allows records to be entered with shifting to align the decimal points.

RESET-ADD, RESET-SUBTRACT

The accumulators may be caused to reset and then add or subtract on a single instruction by placing a 5 in the tenth position of the instruction. For example, to reset accumulator 8 and then add the quantity standing in positions 51-55 of track W, the instruction would be:

FROM		TO		No. Characters	Control
Track	Position	Track	Position		
W	5 5	L	8 9	0 5	5

To reset the accumulator and subtract the same quantity, the instruction would be

FROM		TO		No. Characters	Control
Track	Position	Track	Position		
W	5 5	M	8 9	0 5	5

A reset-add or reset-subtract operation takes the same length of time as a normal transfer—30 milliseconds.

NOTE: Reset multiply is explained later.

READOUT

Readout from the accumulator is the same as a normal transfer operation. To read out the difference developed in accumulator 2 by the instructions in the examples just shown, transferring the answer to positions 60-65 of track W, the instruction would be:

FROM			TO			No. Characters	Control
Track	Position		Track	Position			
L	2	9	W	6	5	06	

After the instruction is completed the result remains in the accumulator.

READ OUT AND RESET

To read out the difference in accumulator 2 and reset the accumulator, the instruction is:

FROM			TO			No. Characters	Control
Track	Position		Track	Position			
M	2	9	W	6	5	06	

When two or more accumulators are read out and reset on the same instruction, all accumulator positions of the affected accumulators are reset. For example, the instruction

FROM			TO			No. Characters	Control
Track	Position		Track	Position			
M	5	4	Y	7	2	10	

reads out the five high-order positions of accumulator 5 and the five low-order positions of accumulator 4, transferring these two fields to track Y. Although only five digits are read from each of them, both accumulators will have all 10 positions restored to zero. Figure 22 illustrates the effect of this instruction on the accumulators.

BEFORE	5 8 7 0 0 1 2 3 4 5										6 7 8 9 0 6 1 0 4 5									
M54Y7210	READOUT					1 2 3 4 5					6 7 8 9 0					RESET				
AFTER	0 0 0 0 0 0 0 0 0 0										0 0 0 0 0 0 0 0 0 0									
	ACCUMULATOR 4										ACCUMULATOR 5									

Figure 22. Effect of Readout-Reset Instruction on the Accumulators

A negative number stands on the accumulator track in a tens complement form. When the accumulator is read out, the number is converted to its true value and the sign is placed over the units position read out. No additional time is necessary for conversion to read out or read out and reset a minus accumulator.

SIGN CONTROL

For algebraic addition and subtraction, sign control is maintained by overpunching the low-order position of each negative field with an 11 (X) punch. The coding of the 12-Zone (X and 0 bits) causes the machine to recognize a 12-overpunch as a negative sign. The negative low-order positions thus stand on the processing tracks as alphabetic characters; for example, the amount -12.45 stands on track W as 124N. When this field is transmitted to the accumulator, the N is sent first, and then the 4, etc. If the instruction requires that this amount be added into the accumulator, the negative overpunch will cause the true amount, 1245, to be subtracted. If the instruction requires that this amount be subtracted into the accumulator, the presence of the negative overpunch will condition the accumulator to add the amount, thus maintaining the algebraic sign control.

When more than one field is transmitted to the accumulators on a single instruction, the machine looks for a sign overpunch on the first character transmitted. This low-order digit need not be read into the units position of the accumulator. The add-subtract controls are conditioned by the sign of the operation and the sign of the transmitted number. The machine looks for a sign overpunch at each in-coming position that enters the low-order position of each subsequent accumulator, and reconditions the add-subtract controls accordingly. Figure 23 shows the effect of a transfer of this type on the accumulators. Although the negative numbers stand on the accumulator track as ten's complements, only true figures are read out.

When a negative accumulator is read out, the sign overpunch is automatically attached to the first digit read out of the accumulator, regardless of its position.

Only the numerical portions of the characters sent to the accumulator track are retained. The signs associated with each of the 10 accumulators are available on the accumulator sign selectors on the process control panel. The accumulator status is also displayed on the console.

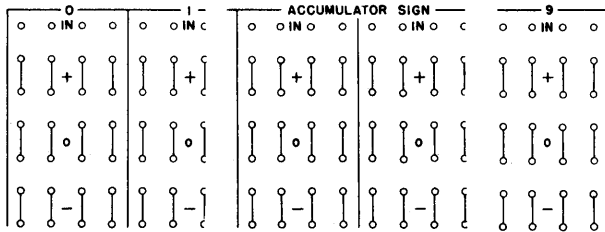

D-K, 1-40

Accumulator Sign. Each accumulator has an associated selector that shows its sign. By using a program exit impulse, the sign selector may be tested to determine if the accumulator is positive, stands at zero, or has a negative balance. A test impulse, wired into the IN hub, emerges from the + hub if the accumulator is positive, from the 0 hub if the accumulator is zero, and from the - hub if the accumulator is negative.

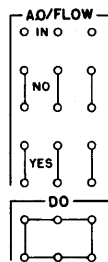

L-S, 1-3

Overflow. If an accumulated amount overflows an accumulator, the accumulator overflow selector is transferred and the overflow light at the console is turned

on. The overflow selector is a latch-type selector; once transferred it remains in that condition until impulsed to drop out on the control panel. When the selector is dropped out, the console light goes out. The programmer may make use of this selector to stop the machine if an overflow occurs, by wiring a PROGRAM EXIT impulse into the IN hub, and from the NO hub to the following program step. If an overflow occurs, the following step will not be set up, and the program will stop. This practice is recommended where there is a possibility that the capacity of an accumulator may be exceeded.

Multiplication

Programming a multiplication is a two-step operation. First, the multiplicand must be loaded on the multiplicand track in the processing unit by a normal transfer instruction. The maximum-length multiplicand is 9 digits, so the number-of-characters part of the instruction must always be coded 09 or less. Ten digits may be loaded for programmed addressing as described later.

The second step is to move the multiplier into the magnetic-core unit and perform the actual multiplication as described below. The product is developed in accumulators 0 and 1; therefore these accumulators should not contain any information needed later. These accumulators should normally be reset before a multiplication is programmed. The multiplier may be as large as desired, however, the maximum size of the product is 20 digits, obtained when the multiplicand contains 9 digits. If the multiplier is greater than 11 digits, the least significant positions of the product will be dropped unless the multiplicand is positioned at the left or high-order positions of each multiplicand track field.

Assume that it is desired to multiply the 9-digit number in positions 82-90 of track W by the 11-digit number in positions 71-81 of track Z. The multiplicand is loaded by transferring positions 82-90 of track W to the multiplicand track, using the T0 address V99 (*other than V99 will cause incorrect operation.*

TRACK X	90					X	99				
	1	2	3	4	5	1	2	3	4	5	
BEFORE	0	0	0	0	0	0	0	0	0	0	
X99L5410	ADD					X					
						1	2	3	4	5	
AFTER	9	9	9	9	8	1	2	3	4	5	
	ACCUMULATOR 4					ACCUMULATOR 5					

Figure 23. Effect of Sign Control Overpunch on the Accumulators

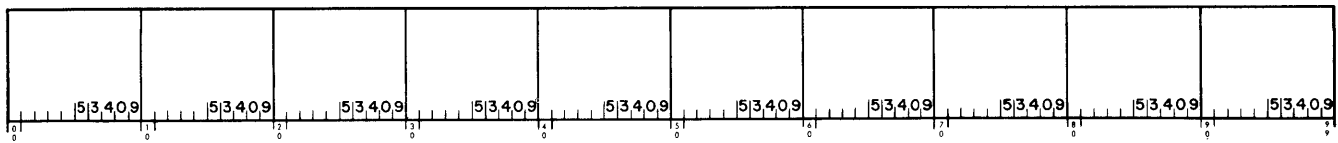

Figure 24. Layout of the Multiplicand Track

FROM		TO		No. Characters	Control
Track	Position	Track	Position		
W	9 0	V	9 9	0 9	

Loading the multiplicand is a normal 30-millisecond transfer operation. The transmitted multiplicand is written around the multiplicand track 10 times, corresponding to the 10 accumulator fields. The multiplicand is always written in the low-order positions of each field of 10 characters, and the remainder of the field is reset to blank. Any character transmitted to the multiplicand track is carried in full; zones and sign marks remain on the multiplicand track but are not used in the multiplication. A single multiplicand may be carried through

several multiplications for group multiplication (Figure 24).

Multiplication begins when the machine receives an instruction with the TO address N99 (*other than N99 will cause incorrect operation*). The transmitted multiplier is automatically sent to the magnetic-core unit. Under the control of successive multiplier digits, the multiplicand is read out and added into accumulator 0. The partial product from each digit of the multiplier is developed in one drum revolution (10 milliseconds).

During each 10-millisecond cycle, the partial product previously developed is shifted one place to the right in accumulators 0 and 1, and the multiplicand is added into accumulator 0 the number of times specified by the multiplier digit. During these operations all sign control is inactive, and the product is always positive.

The product is developed in accumulators 0 and 1. If this product results from a 1-digit multiplier, the product will be entirely in accumulator 0. For each additional

INSTRUCTION	OPERATION	PARTIAL PRODUCT	ACCUMULATORS	START	TIME MILLISECONDS
				END	
Z05L0701b5	Reset add 5 for half-adjustment		0000000500	0000000000	30
W90V9906	Load 6-digit multiplicand		0000000500	0000000000	30
W84N9905	Load 5 digit multiplier, multiply X 9	0007346961	0000000050 0007347011	0000000000 0000000000	30
	Multiply X 1	0000816329	0000734701 0001551030	1000000000 1000000000	10
	Multiply X 4	0003265316	0000155103 0003420419	0100000000 0100000000	10
	Multiply X 3	0002448987	0000342041 0002791028	9010000000 9010000000	10
	Multiply X 5	0004081645	0000279102 0004360747	8901000000 8901000000	10
L11W5009	RO Product		0004360747	8901000000	30

Figure 25. Method of Multiplication

multiplier digit programmed, the low-order digit of the product is shifted one position into accumulator 1. The total number of multiplier digits programmed is specified by the number-of-characters part of the program step that starts multiplication:

FROM		TO		No. Characters	Control				
Track	Position	Track	Position						
Z	8	I	N	9	9	I	I		

If the multiplier exceeds 11 digits, the excess low-order digits of the product developed will be lost by shifting out of the low-order position of accumulator 1 unless the multiplicand is positioned at the left or high-order positions of each multiplicand track field. For example, 15 digits can be multiplied by five digits if the five digits representing the multiplicand are loaded on the multiplicand track so that each field contains four zeros in the low-order positions.

The position of the low-order digit of the product in accumulator 1 is given by the formula:

$$\text{no. of digits in multiplier including high-order zeros} + 8 = \text{address of low-order position of product}$$

For example, when the multiplier is four digits, the address of the low-order product digit is L (or M) 12.

RESET-MULTIPLY

A 5 in the tenth position of a multiply instruction, causes accumulator 0 and 1 to be reset before the product is formed. If the product is not being half-adjusted, the reset-multiply instruction can be used to insure that accumulator 0 and 1 are clear before the product is formed.

HALF-ADJUSTMENT

When decimals are dropped from a product, it may be necessary to correct the number that is retained to the nearest remaining decimal value. For example, to retain two decimal places from the product 12.7945, the value is 1279; but from the product 12.7954 the value is 12.80. The last decimal retained in a multiplication may be half adjusted by adding a 5 into the highest-order position dropped. In this example, the 5 is added into the thousandths decimal position. When the product is 12.7945, adding the 5 raises it to 12.7995, and the last two decimal places are dropped, leaving 12.79. When the product is 12.7954, adding the 5 raises it to 12.8004, and

when the last two decimal places are dropped, 12.80 is left. The method of programming a half-adjustment is shown in the example of Figure 25, which also shows how the product is built up through repetitive adding into accumulators 0 and 1.

For half adjustment, note that the 5 is placed in accumulator 0 one position higher than the number of places to be dropped. Because the accumulators shift to the right before the first multiplication occurs, the 5 is shifted to the correct position before the first partial product is added.

The position to half-adjust can be readily determined by using the formula:

$$(09) - (\text{the number of decimals to be dropped}) = \text{position to half-adjust.}$$

Programmed Division

Direct division is available as a Special Feature and is discussed in the *Special Feature Section*. If this device is not installed, division can be programmed. Three approaches that may be used are: multiplying by reciprocals, trial divisor, and successive subtraction.

The division special feature has the advantage of speed and programming simplicity; however, if the number of divisions executed are few, programmed division by one of the above mentioned systems may be practical.

Division by successive subtraction is presented to demonstrate one method of programmed division.

In this routine, the divisor is subtracted from the dividend in successive steps starting with the high-order position of the dividend. Each subtraction cycle is counted to develop the quotient, and the accumulator is tested for a minus condition. When the accumulator turns minus, the divisor is added back to the dividend one time, and the quotient count is corrected. The remainder and quotient are then shifted one column to the left, and the routine is continued.

A blank track (30 positions) is required to carry the divisor, quotient count (-1), and a constant (1) which is referred to as a housekeeping count. These factors can be entered on this track from an emitter track in positions corresponding to the accumulator track where they will be used. The high-order position of the divisor is in position 1 of the blank track, the quotient count (-1) in position 29, and the housekeeping count (1) in position 30.

NOTE: The last two items are shown as being set up during the division routine; however, they could be

Prog. Step	FROM		TO		No. Characters	Control
	Track	Position	Track	Position		
00	W	3 4	Z	*0 *5 *0 *4		
01	X	*2 *1	Z	2 9 0 1		
02	X	*3 *9	Z	3 0 0 1		
03	W	2 5 L	*1 *0 *0 *6	6 5		
04	X	*4 *1	L	3 0 0 1		
05	Z	2 9 M	2 9 2 9	A		
06	Z	3 0 L	3 0 3 0	B		
07	M	2 9 L	2 8 2 9			
08	Z	2 9 M	2 9 2 9	C		

I SET-UP ROUTINE

Transfer divisor to working storage track (Z) with high-order position to correspond with position 1 of accumulator 0.

Set up quotient count as a -1 on working track (Z) so that it will correspond with the low-order position of accumulator 2. Note that when the divisor is subtracted from the dividend in later steps, the quotient count is subtracted (added) as a -(-1) in accumulator 2. Track X is a constant or legend track used for setting up track Z.

Set up the housekeeping count by emitting a "1" onto storage track Z adjacent to quotient count so that it can be added into the high-order position of accumulator 3 on the restore cycle as described later.

Reset--add dividend in accumulator 0-1 in proper position according to rule.

Add a factor in the high-order position of accumulator 3 of 9 minus the number of quotient digits desired. The housekeeping count is added to this figure on each restore cycle, and the accumulator overflow selector on the control panel can be used to signal the end of divide routine.

Subtract divisor from accumulator 0 and subtract (add) the quotient count to accumulator 2. Test accumulator 0 on the control panel to see that factors are correct. If accumulator 0 is plus or zero, this indicates improper factors such as 0000 divisor, and the program should be stopped to indicate an impossible condition to the operator. If accumulator 0 is minus, proceed to the basic loop of the routine in step 06.

II RESTORE--TEST FOR END--SHIFT

Restore cycle. Add the divisor back to the dividend to restore accumulator 0 to plus. Add (subtract) quotient count to restore the over count of the previous step. Add housekeeping counting to accumulator 3. Test the overflow selector on the control panel. If an overflow exists (which will occur only on the succeeding passes through this loop), it signals the end of divide routine for return to the regular program. If no overflow, continue through basic loop on step 07.

Shift dividend or remainder and quotient one column to left in accumulators 0-1-2.

III SUCCESSIVE SUBTRACTION

Subtract divisor from dividend and subtract (add) quotient count in accumulator 2. Test accumulator 0 on control panel. If plus or zero, repeat step 8. When accumulator 0 is minus, return to step 06 to restore the over-subtraction and the quotient count, and adjust the housekeeping count. Steps 06 through 08 are repeated until the end of the routine, and step 08 is repeated within this basic loop as many cycles as are required.

NOTE: * These items vary with application

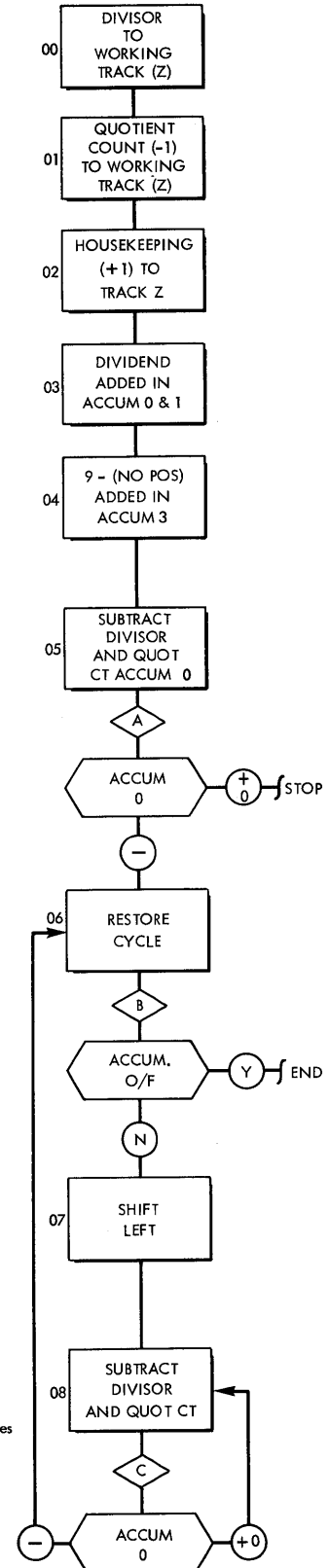

Figure 26. Division by Successive Subtraction (Program)

established during the original program loading. This would eliminate these two steps on each division operation.

The dividend may be up to 19 digits. It is added into accumulators 0-1 with the high-order position shifted left as far as possible based on the application. This location is dependent on the size of the divisor, as well as the quotient to be developed. In the simplest situation, a 4-digit divisor (in positions 1-4) would require that the high-order position of the dividend be entered in position 05 of accumulator 0. This provides for a divisor of 0001 and prevents division by zero.

Using the preceding rule for locating the dividend may, in many cases, cause a waste of process time. For example, to divide total earnings by hours worked to determine actual hourly rate on a payroll application, the maximum hours (divisor) may never exceed 110.00, and the maximum earnings (dividend) may never exceed 999.99. If, however, past experience shows that the hourly rate never exceeds 12.75 (four digits), strict adherence to this rule would waste processing cycles, because the maximum quotient would be developed as 00012.75. In this situation, therefore, the dividend should overlap the divisor by three digits to save excess

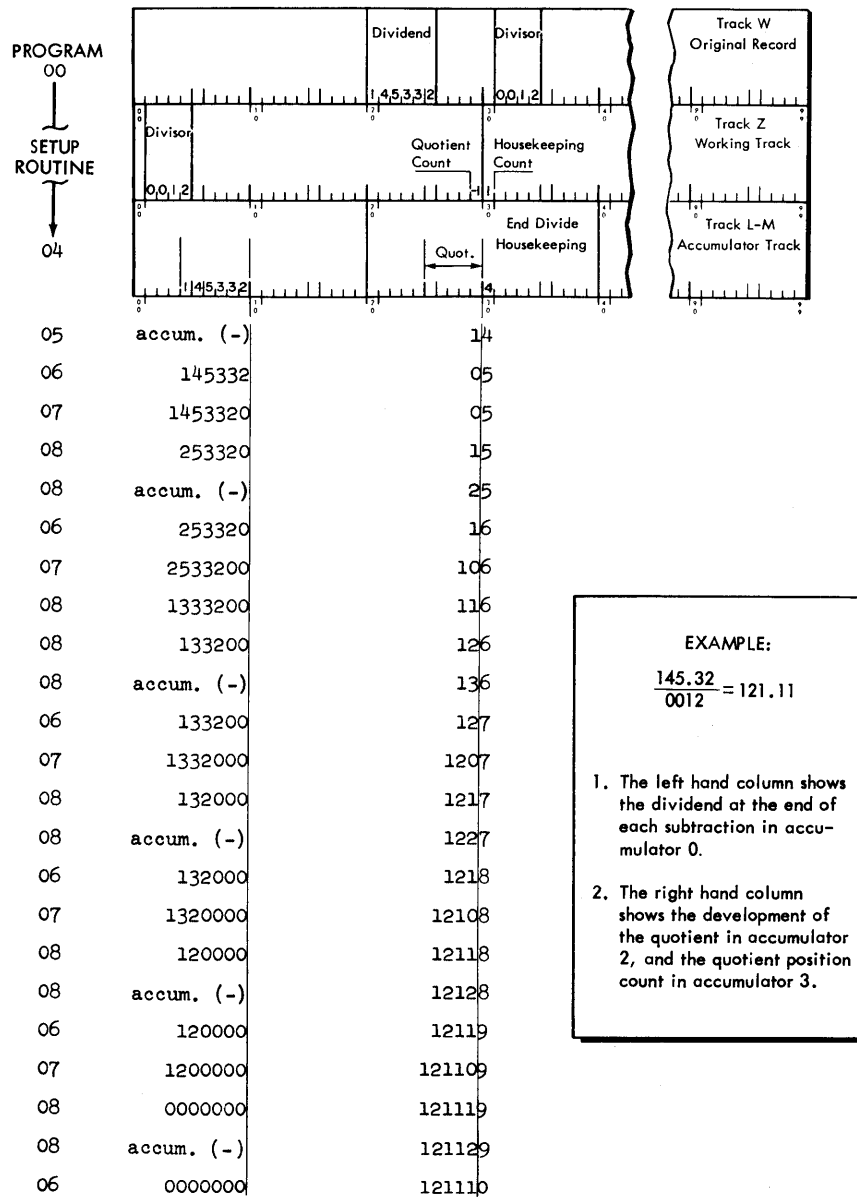

Figure 27. Division by Successive Subtraction (Example)

cycles. This requires that the dividend be entered in accumulator 0-1 with the high-order position located in position 03.

The following rule has, therefore, been developed to determine the location of the dividend to meet the requirements of a specific application.

NOTE: The numbers illustrate the preceding hourly rate situation:

Digits to left of decimal in divisor plus 1	4
Add maximum number of possible digits to left of decimal in quotient	2
	6
Subtract digits to left of decimal in dividend	-3
	3
Enter high order position of dividend in position . . .	3

Accumulator 2 develops the quotient in the low order positions. Accumulator 3 is used for housekeeping (to count the number of positions in the quotient and the divide routine). The difference between 9 and the number of quotient digits (9's complement) is entered in the high-order position of the accumulator. An accumulator overflow signals the end-of-divide routine.

Figure 26 shows the block diagram and program for dividing total value by total quantity to arrive at average cost.

$\frac{\text{Total Value}}{\text{Total Quantity}}$	=	Average cost per item
$\frac{\$XXXX.XX}{XXXX}$	=	\$XXX.XX/item
$\frac{\$1453.32}{0012}$	=	\$121.11/item

Figure 27 shows the track layout and the accumulators at the end of each step as the division program is executed. The factors on track Z are aligned to provide simultaneous addition and subtraction in the accumulators.

CLEARING DISK STORAGE

IN PREPARING to load new records into the file, it may be desirable that each disk record have its disk address recorded on it. This allows a comparison to be made as the new record is loaded to insure that it is being placed in the correct file position.

In order to clear the disk records and write the five digit address in positions 00-04 of each record, the block diagram and program shown in Figures 28 and 29 may be executed. The Program Load key is used to feed the instruction load card and the COPY OUT hub is wired to set programming to step 190. The starting address (punched in columns 71-75 of the disk clear card) is

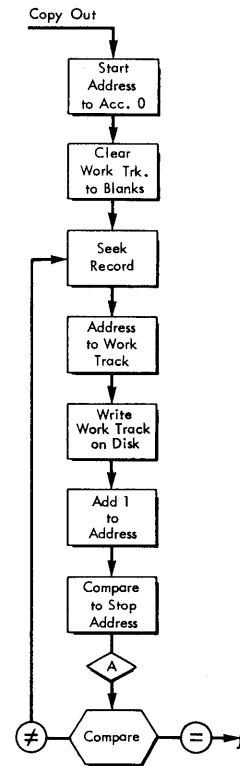

Figure 28. Block Diagram for Clearing Disk Storage

read to an accumulator and a working track is cleared to blanks. The address of the first record is sent to the address register to start the seek. While the arm is moving to this record, the address is also recorded in the first five positions of a blank working track. When

Prog. Step	FROM		TO		No. Characters	Control
	Track	Position	Track	Position		
190	I	7 4	L	0 4	0 5	5
191	6	9 9	W	9 9	0 0	
192	L	0 4	J	9 9	0 5	
193	L	0 4	W	0 4	0 5	
194	W	9 9	R	9 9	0 0	
195	I	6 9	L	0 4	0 1	
196	L	0 4	I	7 9	0 5	A 1

This instruction transfers the starting address which is in columns 71-75 of the card into accumulator 0 in positions 00-04.

A working track (W) is cleared to blanks.

The address of the first record is transferred to the address register to move the access arm to the desired location.

The address is transferred to positions 00-04 of the working track.

The assembled record on W is written on the disk record.

The address is increased by 1 by adding a constant from instruction 196, the tenth position.

The new address is compared with the stopping address. If the stop address and the new address are equal, the program is stopped. If they are still unequal, the program re-enters at step 192 to seek the next record.

Figure 29. Program for Clearing Disk Storage

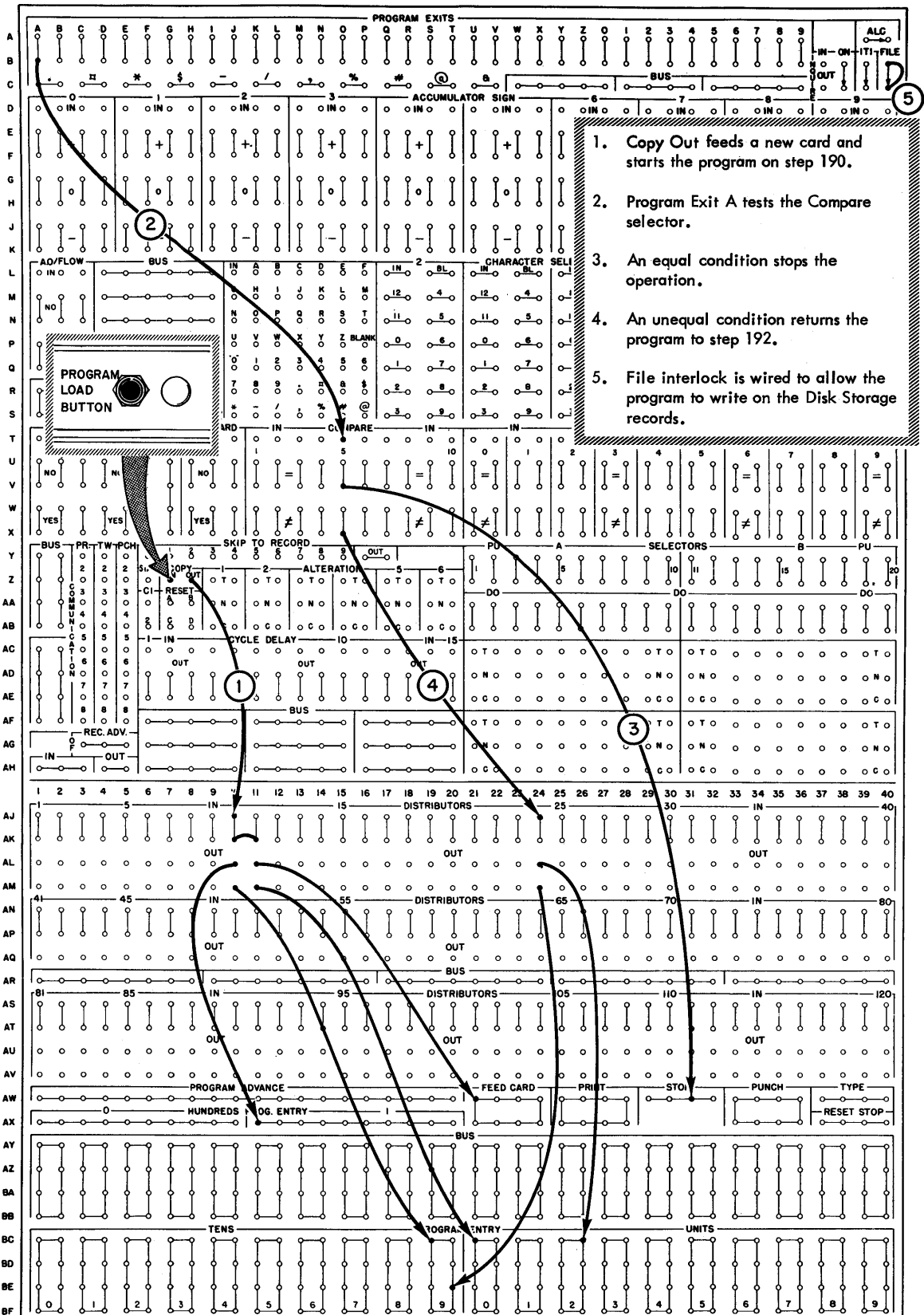

Figure 30. Control Panel Wiring for Clearing Disk Storage

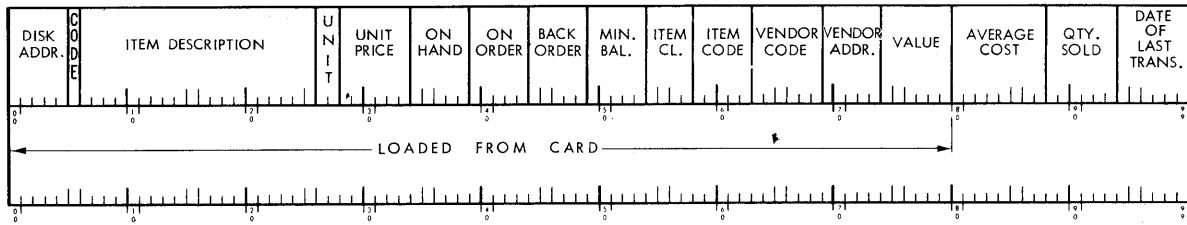

Figure 31. Track Layout of an Item in Disk Storage

the record has been found, the assembled working track is written in the file. The address in the accumulator is increased by one and if the stopping address (last record to be cleared plus one, columns 76-80) has not been reached, the procedure is repeated with the new address. Figure 30 shows the control panel wiring necessary to clear disk storage.

If it is desirable to clear only certain records which are distributed through the file, a group of index cards may be used to provide the addresses instead of an accumulator.



B-C, 40

File Interlock. This interlock is provided so that new programs may be tested without changing the information on the disks. When a program has been checked out, this switch is jackplugged to allow the program to change the records in the memory. All operations except writing on the disks may be performed with this interlock unplugged. If the interlock is not wired, a File Check (See *Internal Checking*) will occur whenever the program tries to write on the file.

LOADING DISK STORAGE

WHEN the machine is first installed, the sectors of the disk storage unit must be loaded with the accounting records before processing can begin. The following program is presented as a method of loading the disk storage.

It will be assumed that the memory is to be loaded with item records for an inventory of small parts. For the most direct access to the disk memory, these parts have been given part numbers between 00001 and 49999. Information pertaining to these parts is recorded on the disks in the corresponding locations. For example,

the inventory record for part number 12345 is recorded at disk address 12345. (Methods of solving the addressing problems for larger numbers are presented in a latter section on *Disk Storage Organization*.)

Figure 31 shows the track layout of an item record in the disk storage sector. Positions 00-79 contain the in-

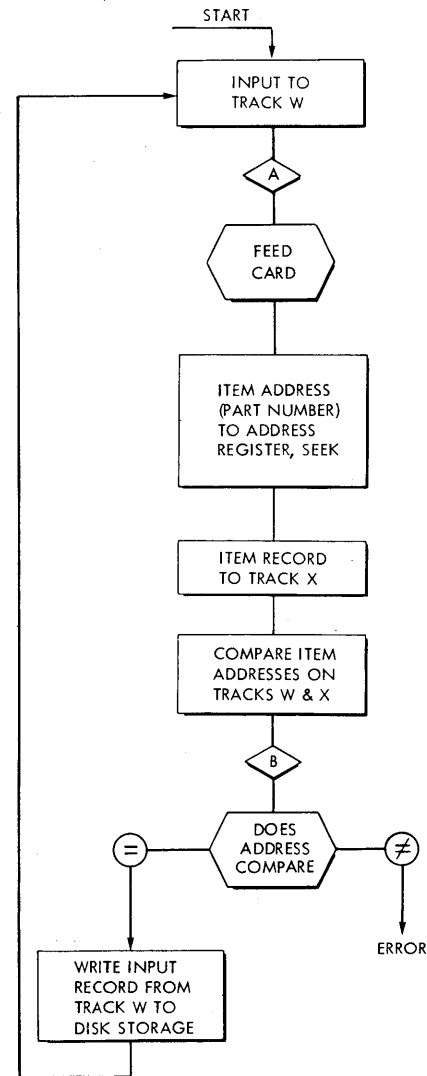
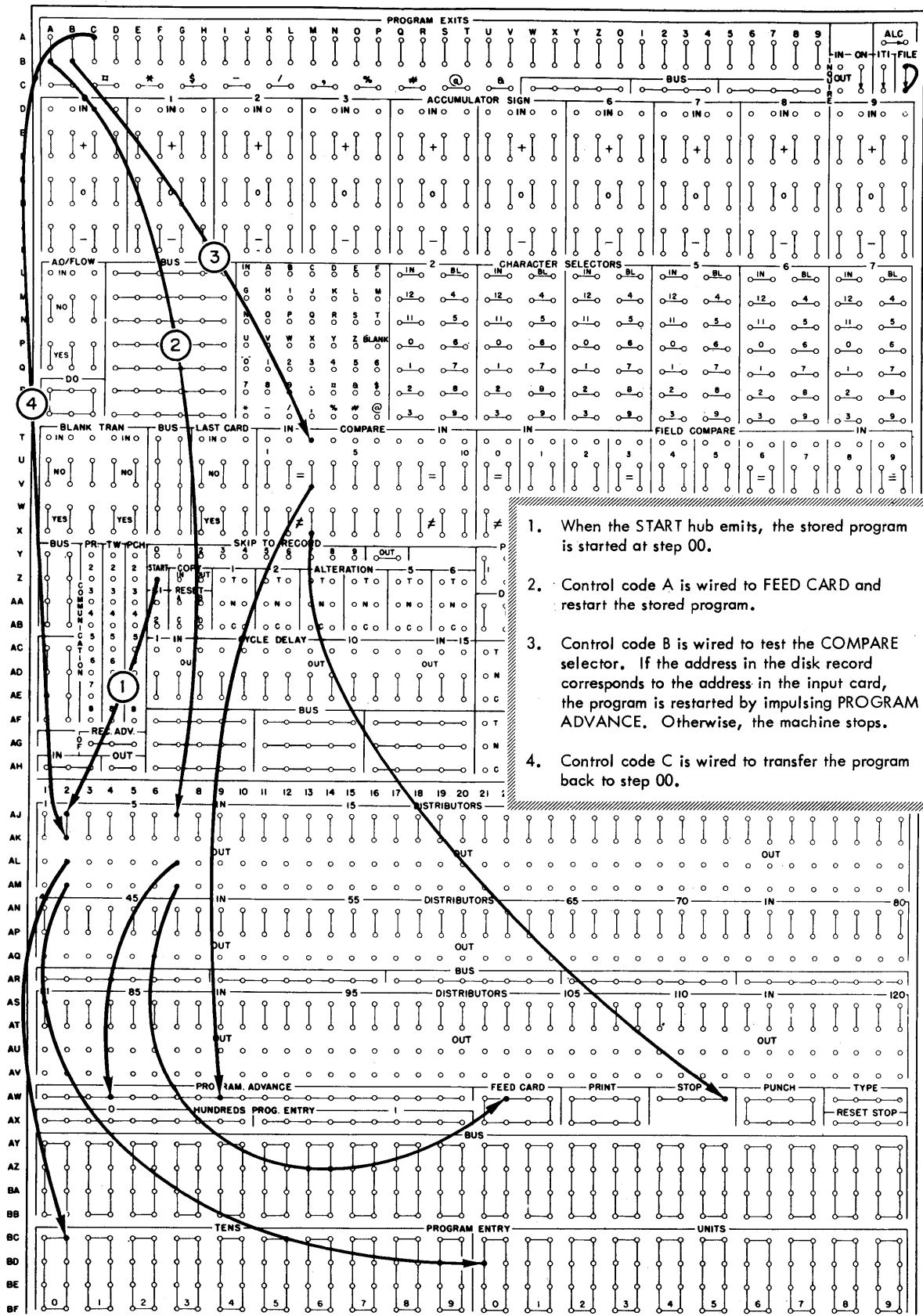

Figure 32. Block Diagram of a Disk Storage Loading Program



1. When the START hub emits, the stored program is started at step 00.
2. Control code A is wired to FEED CARD and restart the stored program.
3. Control code B is wired to test the COMPARE selector. If the address in the disk record corresponds to the address in the input card, the program is restarted by impulsing PROGRAM ADVANCE. Otherwise, the machine stops.
4. Control code C is wired to transfer the program back to step 00.

Figure 33. Control Panel Wiring for Loading Disk Storage

formation about the part that will be loaded from input cards. Positions 80-99 contain information on usage of the part that will be accumulated as time passes. This arrangement allows the programming to be simplified, and results in faster loading of the memory, because only one card must be fed for each item.

For the purpose of checking, it will be assumed that the disk address is recorded on the first five positions of each sector as outlined in *Clearing Disk Storage*. This address will be used to prove that the records are loaded on the proper sectors.

Figure 32 diagrams the steps needed to load the memory. When the first card has been fed, recorded on the input track and checked, the START hub emits. The wiring labeled 1 in Figure 33 starts the stored program at step 00. So that a new card may be fed immediately, the information on the input track is transferred to processing track W, and a new card is fed, checked and recorded on the input track.

The part number on the input card on track W is sent to the address register to cause the disk access arm to move to the proper location in the memory. Then the location of the arm is checked by reading the sector to processing track X and comparing the part number on the input card with the address pre-recorded on the track. If the two addresses are equal, the input record is written into the memory, and the wiring labeled 4 in Figure 33 transfers the control back to the starting point to process the next card. The program instructions are as follows:

Prog. Step	FROM		TO		No. Characters	Control
	Track	Position	Track	Position		
00	K	9 9	W	9 9	0 0	A
01	W	0 4	J	9 9	0 5	
02	R	9 9	X	9 9	0 0	
03	W	0 4	X	0 4	0 5	B 1
04	W	9 9	R	9 9	0 0	C

This instruction transfers the input track to processing track W. The control code A brings the control to the control panel where FEED CARD and PROGRAM ADVANCE are impulsed.

The address (Part Number) in the first five positions of track W is sent to the address register to cause the access arm to move to the desired location.

The record at the address is brought to processing track X so that the sector address may be compared.

The item address from the input record is compared with the sector address. The control code B tests the COMPARE selector. If equal, the program continues to step 04. Otherwise, the machine stops.

If the item address and the sector address compare, the input record is written in the sector. Control code C transfers the program back to step 00.

START

Z, 6

Start. When the input card has fed past the second reading station, and the input track has been recorded and checked, this hub emits an impulse that may be wired to start the stored program at any desired step, and initiate other functions.

RESET STOP

AX, 37-40

Reset Stop. These hubs may be impulsed from a program exit impulse when processing is to be halted. Impulsing these hubs will reset the processing unit, and place the machine in an inquiry-only mode of operation so that manual inquiries may be made. (See *Console Operating Procedures*.) Restart by depressing the start key.

STOP

AW, 29-32

Stop. Impulsing these hubs will stop the program. The machine will stop on the INSTRUCTION cycle of the

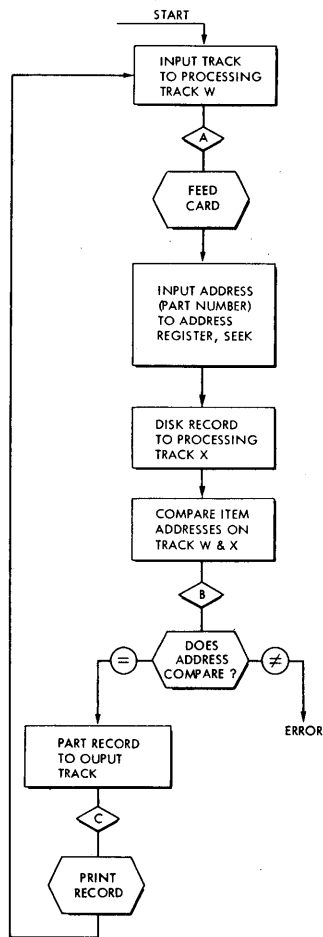

Figure 34. Block Diagram of a Disk Storage Unloading Program

next program step and may be restarted by depressing the Program Start key on the 380 console providing the impulse that is wired to STOP is also wired to advance programming. If programming is not advanced, the machine will stop and indicate continuous DELAY and EXIT cycle lights on the console.

UNLOADING DISK STORAGE

AT REGULAR intervals, it may be desirable to print out sections of the memory for a permanent record. The records may be read out in numerical sequence by the use of arithmetic, as described later. Another method, that allows the records to be printed out in any order desired, is to have a deck of cards with the memory addresses punched in them, one to a card, along with other pertinent codes. These cards may be arranged in any order desired; then when they are placed in the card reader and fed into the machine they may cause the memory to be read out and printed in that order.

Figure 34 diagrams the steps for this method of unloading the memory. The part number from the input track is used to cause the access arm to locate the record in the disk memory. The record is transferred to processing track X, and the address is compared to prove the access arm reached the desired record. If the proper record has been obtained, it is transferred to the output track and printed.

Prog. Step	FROM		TO		No. Characters	Control
	Track	Position	Track	Position		
00	K	9 9	W	9 9	0 0	A
01	W	0 4	J	9 9	0 5	
02	R	9 9	X	9 9	0 0	
03	W	0 4	X	0 4	0 5	B 1
04	X	9 9	S	9 9	0 0	C

When the start hub emits, the stored program is started at step 00. This step transfers the contents of the input track to processing track W. Control code A causes another card to feed.

The item address is sent to the address register to cause the access arm to move to the desired record.

The disk record is brought to processing track X so the recorded address can be checked to insure that the access arm is positioned properly.

The item address on the disk record and the item address on the input card are checked by the comparing unit. If they agree, the program proceeds to step 04; otherwise, the machine stops.

The part record is transferred to the output track, and the control code is wired to cause the printer to print the record and restart the program at step 00.

OTHER LOGIC ELEMENTS

Character Selector. The character selector provides a way of analyzing any character on any drum track as a basis of control. This allows the character in a single control column to bring about multiple decisions. The

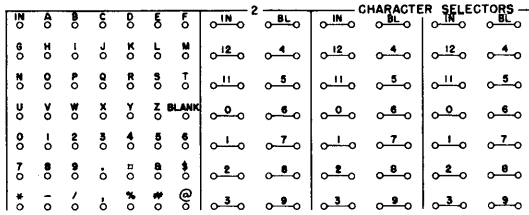

L-5, 10-28

character to be entered into the character selector is sent to this unit by an instruction with the hyphen (-99) code as the TO address (*other than -99 will cause incorrect operation*). For example, to enter the control code recorded in position 05 of processing track W into the character selector, the instruction is:

FROM		TO		No. Characters	Control
Track	Position	Track	Position		
W	05	-99		01	B

Any character thus entered establishes test paths between each IN hub and the exit hubs corresponding to the character entered. On the basic machine, four distinct paths are set up. Three of these paths are arranged so that a program exit impulse entered into the IN hub emerges from the hubs corresponding to the IBM card code of the character being tested. For example, if an A code is entered in the unit, a program exit impulse wired into any one of these IN hubs would emerge from the 12 and the 1 hubs under that IN hub. Special characters emit zone and upper punch only; for example, the character * (X, 4, 8) emits X and 4.

In the fourth path, a test impulse wired into the IN hub emerges from only one of the 48 exit hubs representing the specific letters, numbers, special characters, and blank. The paths remain set up until another character is addressed to the unit.

There is a relay for each of the possible six character bits. If more than one character is sent to the character selector during the same instruction the relays will be picked for all bits present in the combined characters. Thus, different characters than ex-

pected may be created in the character selector. For instance, if an instruction W05-9902 transfers a 1 and 4 to the character selector, the 1 and 4 bits would combine to set up a value of 5. However, if a 1 and 5 were transferred, the value would still be 5.

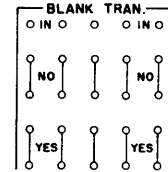

T-X, 1-5

Blank Transmission. Testing for a blank transmission is controlled so that it takes place only if there is a control code of 6 in the tenth position of a transfer instruction. If the results of this transfer are either all blanks or zeros, the selector transfers to a "YES" condition. If any significant data is transferred, the selector is set to "NO." Once the selector is set to "YES," the Blank Transmission light on the console turns on, and the selector remains transferred until the beginning of another transfer instruction which contains a control code of 6. The selector is then set up to indicate the condition recognized during that transfer. Transfers made without the control code do not affect the setting of the blank transmission selector.

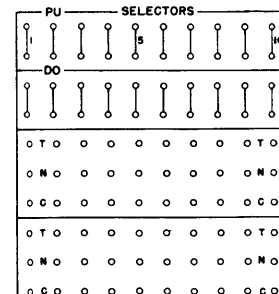

Y-AH, 21-30

Selectors. For the storage and analysis of control functions, latch-type selectors are provided. Each selector has two positions, and each position has a common, a normal, and a transferred hub. The COMMON hub is connected to the NORMAL hub until the selector is picked up by impulsing the PICKUP hub. Then the COMMON hub is connected to the TRANSFERRED hub until an impulse is sent to the DROPOUT hub.

Selectors furnish a convenient means of "remembering" specific routines that the machine has executed in the course of a program, especially when a number of

alternate program sequences are possible. They may also be used to count the number of times that the machine goes through a certain routine. For example, it may be desired to substitute another item from stock if the item on an input order card is out of stock. If the item record of the ordered item contains the address of a possible substitute, the machine may look up the substitute record, and if enough stock is on hand, invoice the substitute. However, the substitute record could have as a substitute the address of the original part. If the substitute were out of stock, the machine would look up the record of the original part again, then go back to the substitute, etc. To prevent the machine from doing this, a selector may be used to allow the machine to look up one substitute, but to prevent going back to the original item record.

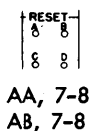

Reset. Because it is frequently desirable to start a program sequence with all selectors dropped out, the selector reset hubs are provided. Impulsing hub A drops out the 10 selectors of the A group, B for the B group, etc.

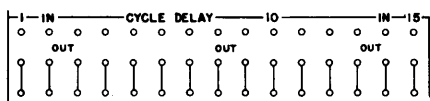

AC-AE, 6-20

Cycle Delay. These units provide a delayed impulse that may be used for control functions such as the pickup and dropout of selectors. The Program Exit impulses are normally wired through selectors to control branching; these impulses should never be wired to the pickup or dropout of selectors they are testing, because this would cause the selector to change state while the impulse is passing through, resulting in erroneous operation. Instead, the impulse is wired into the Cycle Delay IN hub; it is stored and emitted from the corresponding OUT hub after the Program Exit impulse has ended. The exit from the cycle delay is timed to allow selectors to be picked up or dropped out when there is no danger of disrupting a test impulse.

Impulsing Cycle Delay IN causes three additional 10-millisecond cycles to be added to the basic cycle—two *delay* cycles and an *exit* cycle during which the Cycle Delay OUT hub emits. When a Cycle Delay IN hub is impulsed, four internal selectors remember

which OUT hub should emit. These selectors are assigned the values 1, 2, 4, and 8, similar to the coding used on the drum. If the number 3 IN hub is impulsed, internal selectors 1 and 2 transfer, and the number 3 OUT hub emits. If the IN hubs for Cycle Delay 3 and 4 are impulsed simultaneously, the OUT hub of Cycle Delay number 7 will emit (1, 2, 4, is 7). If the 2 and 3 IN hubs had been impulsed, the 3 OUT hub would emit (internal selectors transferred are 1 and 2).



Z-AB, 9-20

Alteration Switches. A row of toggle switches on the operator's panel at the console are provided to allow various changes to be made in the program setup by changing the settings of the switches. On the control panel, these switches are wired in a manner similar to selectors. Program Exit impulses wired into the IN hubs emerge from the N (normal) hub of the same vertical row if the corresponding toggle switch is in the normal position, and will emerge from the T (transferred) hub when the toggle switch is transferred.



AA-AB, 6

Control Impulse. Two keys are provided on the operator's panel at the console to allow a control impulse to be emitted on the control panel. This allows the operator to pick up or drop out selectors, or initiate other functions, from the console. The impulses are emitted from the correspondingly-numbered CI (control impulse) hubs on the control panel.



A, 39-40

ALC (Automatic Last Card). If the ALC switch is not plugged when the cards have run out of the card hopper, and if the last card has passed the second reading brushes, the card reader will stop. The last card information will have been transferred to the

input track, and processed. The reader will then interlock on the next programmed instruction calling for a transfer of information from the input track. The operator may depress the reader start key with the Ready light out, and feed cards to the stacker. Just after the operator depresses the start key, a dummy (blank) record is transferred to the input track, and the Last Card Selector transfers.

If the ALC switch is plugged, the card reader feeds the last card past the second reading brushes, processes this card, then feeds one additional cycle before stopping. During this additional cycle a blank record is transferred to the input track; the Last Card Selector transfers, and any last-card routines (that have been programmed utilizing the Last Card Selector) can be completed. The cards may then be fed into the stacker by depressing the reader start key.



B-C, 37-38

Inquire. The pair of hubs marked ON form a switch that must be jackplugged if inquiries to the disk records are to be allowed.

The IN-OUT hubs form an interlock that is wired to allow the console to take control of the access arm at a time when it will not countermand the stored program instructions. The INQUIRE interlock is impulsed in the program at a point where the access arm has completed its use of the record, and is ready to move the access arm to some other record. If the arm is about to be moved by the program, no harm will be done if the operator moves the access arm to some other record to make an inquiry. When the record has been obtained for the operator, the stored program resumes control and moves the arm to the next record required.

A control impulse wired into the IN hub emerges immediately from the OUT hub if no inquiry has been set up at the console. The impulse from the OUT hub is wired to initiate the next program step.

The operator initiates an inquiry by depressing one of the three format keys, Format 1, 2, 3, on the keyboard at the console. The five digit address may be keyed in as soon as the inquiry light comes on at the console. If the ITI hubs are not wired this light turns on immediately upon depressing one of the Format keys. If the ITI hubs are wired, the inquiry light does not come on until the next time the program reaches

the point where the Inquire IN hub is tested. In either case, as soon as the address has been keyed in and the Inquire IN has been impulsed, the access arm moves to the desired record and reads this record to the typewriter (Q) track automatically. When this has been done, the machine emits an impulse from the inquiry OUT hub to restart the stored program. The program proceeds while the requested record is typed from the Q track by the typewriter. (See 380 Console.)



B-C, 39

ITI (Inquiry-Type Interlock). The typewriter may be used to make inquiries to the disk records. The typewriter may also be used as a secondary output printer by addressing the output record to track Q and impulsing TYPE on the control panel. If both of these uses occur in the same program, the INQUIRY-TYPE INTERLOCK must be jackplugged to prevent the keying in of an inquiry address from taking place while the typewriter is under program control. (See Console Operating Procedures).

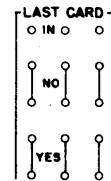

T-X, 8-10

Last Card. This selector is used to control machine operation on the run-out. Normally, a path exists between each IN hub and the NO hub beneath it.

Last card operation is essentially the same with or without the ALC switch plugged. Without the switch plugged, the operation is as follows:

1. The last card passes the lower brushes and is checked. Because there is no card passing the first reading brushes, blanks are written on the K1 track.
2. Transfer-from-input instructions will be executed, permitting the last record to be processed to the extent desired.
3. The next transfer-from-input instruction will interlock the process unit prior to execution of the instruction.

At this point, the operator must determine whether

more cards are to be added or whether the run has been completed. If more cards are added and the Start key is depressed, the first card will feed past the second brushes and will be checked. The transfer-from-input instruction which has been interlocked, will be executed, transferring information pertaining to the first new card from the input track. The Last Card Selector *will not* transfer. Group control, etc. (programmed comparing) will occur as if the reader had not run out of cards.

If the operator determines that the run has been completed, the Reader Start key may be depressed. The runout procedure will be executed as follows:

4. Depress Reader Start.
5. A blank record will automatically set up on the input track — all check bits.
6. The Last Card Selector will transfer.
7. The transfer-from-input instruction which has been interlocked will be executed and blanks will be transferred from the input track.
8. Programmed comparing for group control, etc., can in most cases occur normally since the last record will compare against blanks.
9. The Last Card Selector should be used to direct the program into any special last card routines; e.g., final totals.
10. At completion of the last card routine, a Program Exit should be wired to Reset Stop.

When the Start Key is depressed, the key may be held down and cards will be cleared out of the feed while the last card processing occurs.

Plugging the ALC switch merely has the effect of automatically depressing the Start key on step 4 above.

It is still necessary to use the Start key in order to clear the feed. The primary advantage of the ALC switch is that an operator observing operation at the 370 cannot accidentally remove forms before the last card routines occur. On the other hand, if the switch is plugged, the job must not be susceptible to erroneous processing if the feed is accidentally allowed to run out of cards in the middle of a group.

The switch is useful for small groups of cards, particularly if the groups represent different jobs. It insures that each job is complete when new cards are run in.

The Last Card Selector should be tested on or after the transfer-from-input instruction, but before the processing of the input data. If the Last Card Selector is not tested until after the data has been processed, a blank record will be processed.

	PR	TW	PCH
0	0	0	0
2	2	2	2
0	0	0	0
3	3	3	3
0	0	0	0
4	4	4	4
0	0	0	0
5	5	5	5
0	0	0	0
6	6	6	6
0	0	0	0
7	7	7	7
0	0	0	0
8	8	8	8
0	0	0	0

Y-AF, 3
Y-AF, 4
Y-AF, 5

Communication. These hubs are connected to the correspondingly-numbered hubs of the communication section on the printer, typewriter and punch control panels. They allow for signal communication between the machine units.

Disk Storage Organization

THE disk storage unit is divided logically into 50,000 100-character sectors. The master accounting records must be fitted into these 50,000 sectors. The best arrangement of the accounting records on the disks will be determined by:

1. The number of different types of records that must be stored.
2. The number of records of each type.
3. The number of characters in the records of each type.
4. The method of addressing the records.

Ideally, the accounting records to be stored in the memory are given the account number of their disk address. For example, part number 12345 has its record stored at disk location 12345. This arrangement is called *direct addressing* and it has the obvious advantage that the account number can be used directly to address the disk storage.

When only one type of record is stored in the disk storage, if the account numbers are assigned between 00000 and 49999 they can readily be used for direct addressing. If more than one type of record is stored, it is desirable to group the records in the memory.

EXAMPLE: It is desired to provide disk storage for:

- 15,000 inventory item records
- 8,000 accounts receivable records
- 4,000 accounts payable records
- 4,000 employee records
- 3,000 miscellaneous records

To allow room for future expansion, these records could be arranged as follows:

ADDRESSES

Miscellaneous records 00000-04999 (5 disks)

Accounts payable records	05000-09999 (5 disks)
Accounts receivable records	10000-19999 (10 disks)
Inventory item records	20000-39999 (20 disks)
Employee records	40000-49999 (10 disks)

With the records organized in this way, programming may be simplified because the machine can immediately determine that 12345 is the address of an accounts receivable record.

Because employee records will most probably require more than 100 characters, two sectors have been allowed for each employee record. With this arrangement, the employee record would always start on an even address and end on the following odd address. For direct addressing, employees would be assigned even employee numbers only.

A modification of this system would be to assign employee numbers between 20000 and 24999, assigning both odd and even numbers. An auxiliary code punched in the input card would allow the machine to recognize an employee card. By doubling the employee number, an *even* address between 40000 and 49998 would be obtained. As an example, employee number 23433 would be doubled to 46866, an even address that contains the first 100 characters of the employee record. After sector 46866 is obtained, record advance is impulsed and the machine obtains sector 46867, which contains the last 100 characters in the employee record.

Another advantage that is obtained by grouping records in a manner similar to the example just shown is ease of unloading. Periodically, it will be desirable to punch or print out certain records to obtain a permanent record of the status of the disk storage for auditing purposes. To punch or print out only the accounts receivable records, a program may cause the access arm to obtain record 10000 and then advance to 10001, etc., until 19999 has been processed (see *Unloading Disk Stor-*

age). If the records are not grouped, but are scattered through the memory, it will be necessary to use a deck of cards to specify which of the scattered records are desired.

Where it is not possible to assign a direct disk address it is sometimes possible to punch the disk address in the input cards. Sometimes the disk address can be prepunched in the card; this is the case when IBM time cards are used for input when calculating payroll. It may be possible to append the disk address to the account number. For example, the number 4709GXP could become 4709GXP-23456, where 23456 is the disk address of the desired record.

INDIRECT ADDRESSING

WHERE none of the preceding methods are possible, it will be necessary for the machine to perform arithmetic operations on the existing part or reference numbers to arrive at disk addresses between 00000 and 49999. It is not possible to specify any one method of making this translation; each situation must be studied individually to determine the best method of changing an external address, such as a part or employee number, into a disk address between 00000 and 49999.

Figure 35 shows that indirect addressing is like a funnel directing data into the file. The example illustrates the use of 10,000 file records to store data from a list of identification numbers with possibilities far exceeding this number. However, the maximum number of actual records required is within the limits of the 10,000 record area allotted.

Step 1 is the application of some arithmetic operation to the existing item numbers to create new numbers which fall between 00000 and 99999.

Step 2 reduces the derived number to bring it within the acceptable address range of RAMAC by applying a compression factor. This is accomplished by multiplying the number by .5 to create a number range from 00000 to 49999.

Step 3 applies a second compression factor to bring the addressing range into a limited portion of the file or number of disks. To reduce the file to 10000 records or 10 disks, the number is again multiplied by a factor. In this case, the factor is .2, and the addresses fall into the range 00000-09999.

In actual practice, the compression factors in steps 2

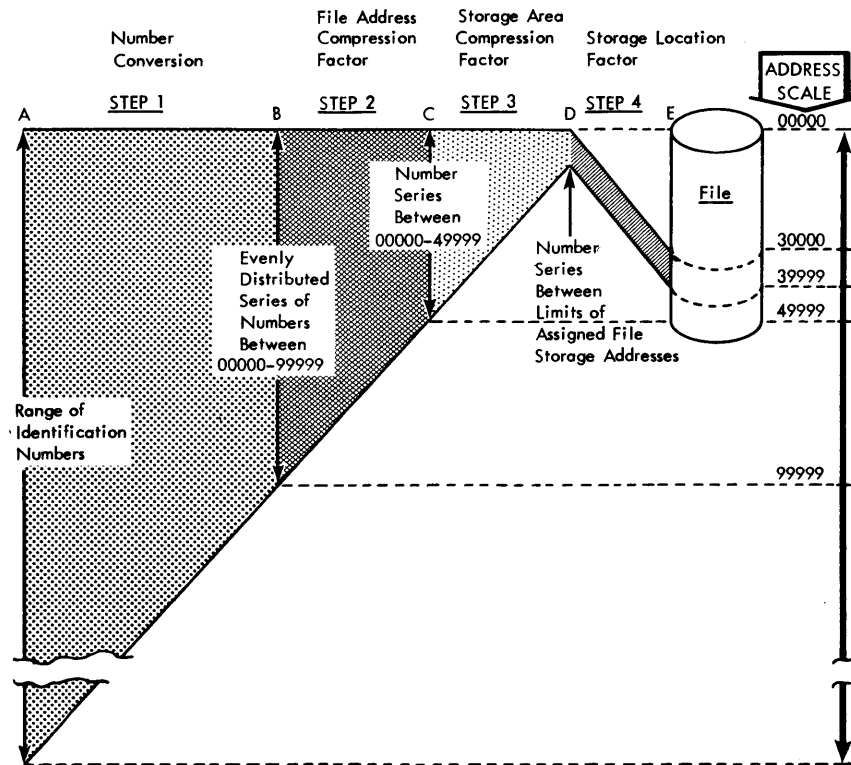

Figure 35. The Four Steps to Indirect Addressing

and 3 would be combined into one factor of .10. Note that this factor is the same as the number of disks into which the file is being compressed.

Step 4 is to add a constant when necessary to place the address within a specific set of disks or records.

Several methods of number conversion have been found to be practical. They are:

1. *Using a fixed portion of the external address.*

Shown below are a random sampling of part numbers from a catalog of a large mail-order firm:

24W356
53TP4152
53T4149
30T1441
MW5092
48T773
78T3560
45TP4959
67TN12

This analysis would normally be made on an entire catalog because a sample will not show a true picture. However, when this part number arrangement is analyzed, it is found to have a two-digit prefix, a one or two-digit letter code and a four digit item code. The following codes are obtained by listing the preceding codes in columnar form and inserting zeros where there are no characters in the code:

24	W0	3560
53	TP	4152
53	T0	4149
30	T0	1441
00	MW	5092
48	T0	7730
78	T0	3560
45	TP	4959
67	TN	1200

The first method that suggests itself is to use the four-digit numerical code with one other digit to generate a unique five-digit address. If the first digit of the prefix code is combined with the four-digit code, some addresses would result that are greater than 49999. To insure that all addresses are acceptable, the machine will automatically subtract 5 from any prefix digit greater than 4 when the number enters the address register. The following addresses would then be obtained:

23560
04152

04149
31441
05092
47730
23560
44959
11200

Other combinations of digits may also be tried. Note that the numerical portions of the alphabetic characters can be used as another digit, and the zone portions can be converted to digits through programming. Conventional punched-card equipment can be used for this analysis.

If a workable address system is obtained by this method, it is possible to punch or print out the unused disk addresses to supply a list for future part number assignments.

This method has the advantage that comparatively little arithmetic must be performed on the part numbers to obtain disk addresses.

2. *Derivation of a Disk Address from Sums.* Another method involves smoothing of the original distribution by converting the existing set of addresses to another set, and in the process, removing practically all of the effects of the original number assignment policy. Several methods for performing this conversion have been developed. One method is to develop new disk addresses from the sums of certain columns in the existing address.

Because the accumulators accept only the numerical portion of the alphabetic characters, the latter can be treated as numbers. The sample part numbers used earlier now become:

24603560
53374152
53304149
30301441
00465092
48307730
78303560
45374959
67351200

NOTE: Alphabetic characters in the units position may cause a subtraction to take place.

Now if the four low-order digits are added to the four high-order digits, but are shifted one position to the left, the following addresses are obtained after 5 is subtracted

from any high-order position greater than 4 in the address register:

2460	
3560	
38060	38060
	46857
	46820
	17440
	00966
	32130
	43430
	04127
	18735

Note that the disk addresses bear no resemblance to the catalog numbers from which they are generated. The effect of this operation is to distribute the records evenly into the 50,000 sectors in the memory. The arithmetic is performed on the external addresses when the record is first entered into the memory, and whenever the record is to be brought from the memory.

3. *Squaring*. Another method of arriving at a random number is by squaring the number and selecting a number from the center portion of the product. For the item address 53TP4197 (zone punching is ignored).

53TP4197 ² =	53374197
	53374197
	373619379
	480367773
	53374197
	213496788
	373619379
	160122591
	160122591
	266870985
	2848804905394809

The center four digits, 4905, are each obtained by adding seven or eight other digits. These four digits can be expected to be the most random in the product, and when additional item addresses are treated in this manner, these digits usually have an even distribution over the numbers between 0000 and 9999. In other words, squaring a number and extracting an address from the center of the square tends to assign addresses in a random manner.

In the event that the original number is too large to be handled in this way, the number could be overlapped and added, as described earlier, and the reduced number could then be squared.

It is not very probable that the procedures outlined above will yield unique internal addresses for all external numbers. As the number of items increase, the probability that an address will be duplicated increases at a rapid rate. These duplicate addresses are called synonyms. To illustrate, suppose ten buckets are placed in a cluster and a blindfolded person throws ten balls, one at a time, into the cluster. The cluster is arranged so that each ball must fall into one of the buckets, and there is an equal chance that it will fall into any bucket. When the first ball is tossed, there is no possibility that it will fall into a bucket that already contains a ball; but when the second ball is tossed, there is one chance in ten that it will fall into the bucket that already contains a ball. When the third ball is tossed, there are two chances in ten that it will fall into a bucket that already contains a ball, provided the second ball did not fall into the bucket containing the first ball. If it did, there is now one chance in ten that the third ball will fall into the bucket containing the other two. From this it can be seen that the chance of the tenth ball falling into an empty bucket is very slight.

Now suppose that 10000 balls are tossed into the ten buckets. There is an excellent chance that about 100 balls will fall into each bucket. As the number of balls is further increased, the probability of an even distribution is increased. Therefore, although it is not very probable that the address modification processes described earlier will yield unique disk addresses, there is an excellent probability that, as the number of records that can be assigned to an address increases, the probability of an approximately even distribution of the records into the storage increases.

Indexing

The organization of the random-access memory suggests a method of applying this principle for programmed addressing. Each disk track contains ten sectors. In effect, a disk track is a "bucket" in which ten records can be stored at the same address. Instead of the 50,000 sectors that store 100 characters each, the memory will be considered to have 5000 tracks, each of which can store up to 10 records of 100 characters each. The techniques shown earlier can be used to generate a 4-digit address between 0000 and 4999. This address is then used to reach the first sector on a track. For example, if the address arithmetic yields 1234 as an address, the arm would be sent to disk number 12, track number 34. If the memory is being loaded, the machine would be programmed to record in the first empty sector on this track.

This technique will result in the majority of records being located at the track address generated by the address arithmetic. Occasionally, more than 10 records would have the same address. When this occurs, the excess records may be stored on overflow tracks. To move the access arm to an overflow track requires another seek operation; therefore, it is desirable to use the overflow tracks for the least-often-used records. This can be done by loading the most-often-used records first; these records will be recorded in preferred locations. Less-used records are then loaded in less desirable positions.

Although it is possible to record ten records on each track, quite often one sector on each track is reserved as an index to the other nine sectors. This method has the following advantages:

1. All but a small percentage of the records are reached with a single movement of the access arm.
2. Additional access motions are limited to items of low activity.
3. The index to the records is automatically constructed and maintained as each item is added to or deleted from the disk storage.

4. Any portion of the memory can be assigned for a group of records. Thus, several different groups of records can be stored in the same disk storage unit.
5. The method can be applied to practically any external addressing system.

CONSTRUCTING AN INDEX RECORD AND STORING A RECORD

The method of constructing an index and loading records into disk storage will now be traced. In the following example, it can be assumed that five synonyms have been previously loaded into record locations 29311-29315 and that data which pertains to part number 72P43921 must now be placed in record location 29316.

To store the new record in location 29316, the 100-character index record (29310) is read from the disk to track X as shown in Figure 36. From track X it is field compared against the multiplicand track which has been previously loaded with blanks. The results of this field comparison will indicate an equal condition for

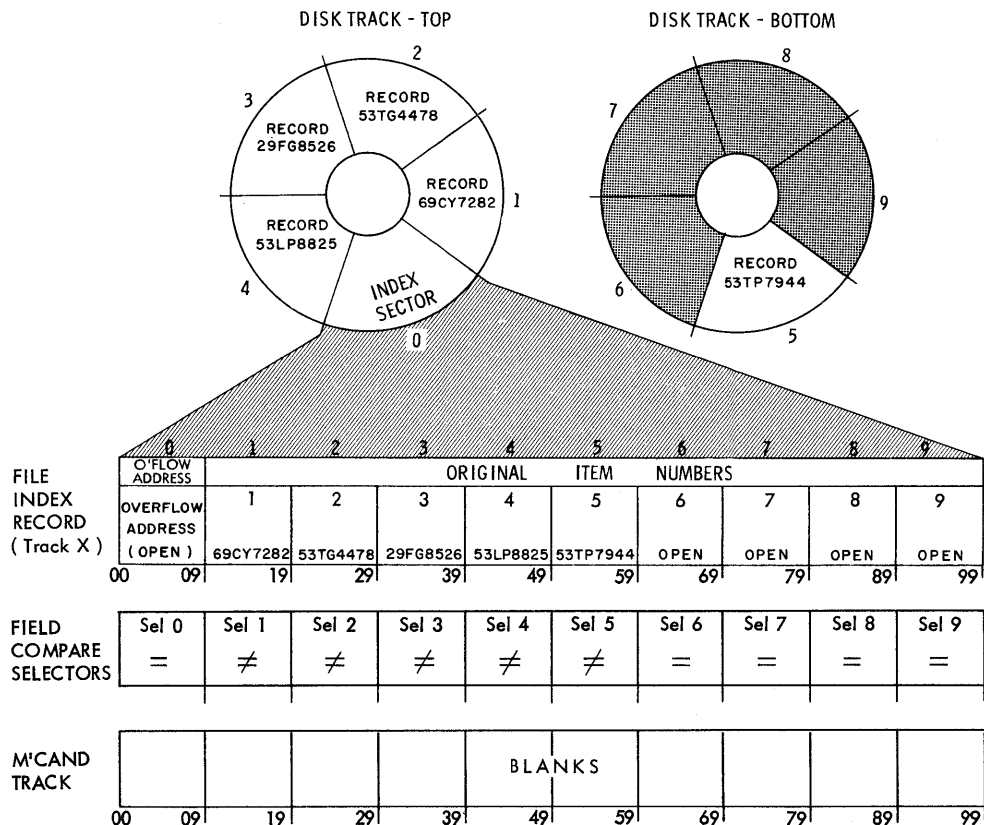

Figure 36. File Index Record

field compare selectors 0, 6, 7, 8, and 9. Track positions 00-09 of the index record are reserved for an overflow address; consequently, field compare selector 6 is the first selector in the series 1-9 which is recognized as having an equal condition. The machine is then programmed to record the item identification number in positions 60-69 of the index record. The index record

is then returned to disk storage, and the field compare selectors are tested again. By utilizing the Skip-To-Record feature, the address of the open record location (29316) is obtained. Because the access arm is already positioned on the track, no movement of the arm is required. The record for part 72P43921 is now recorded in record location 29316.

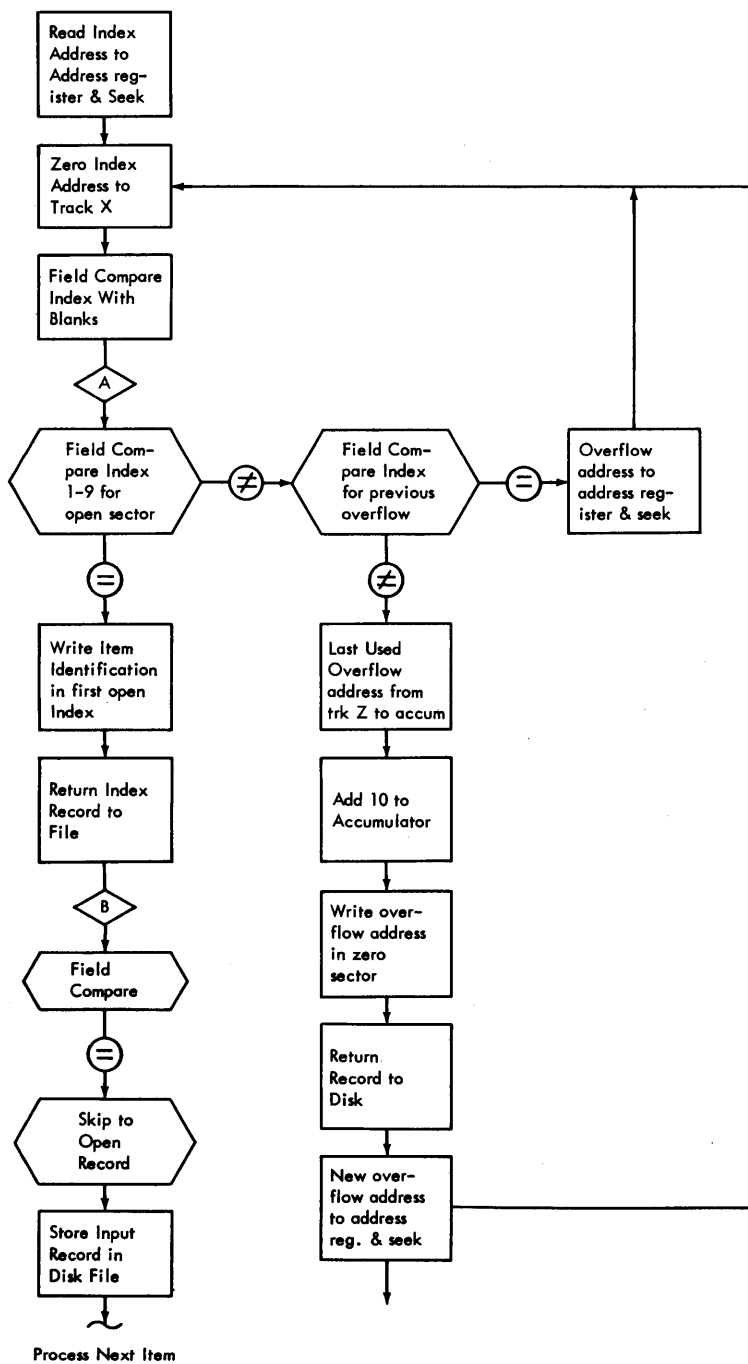

Figure 37. Constructing an Index Record and Storing a Record (Block Diagram)

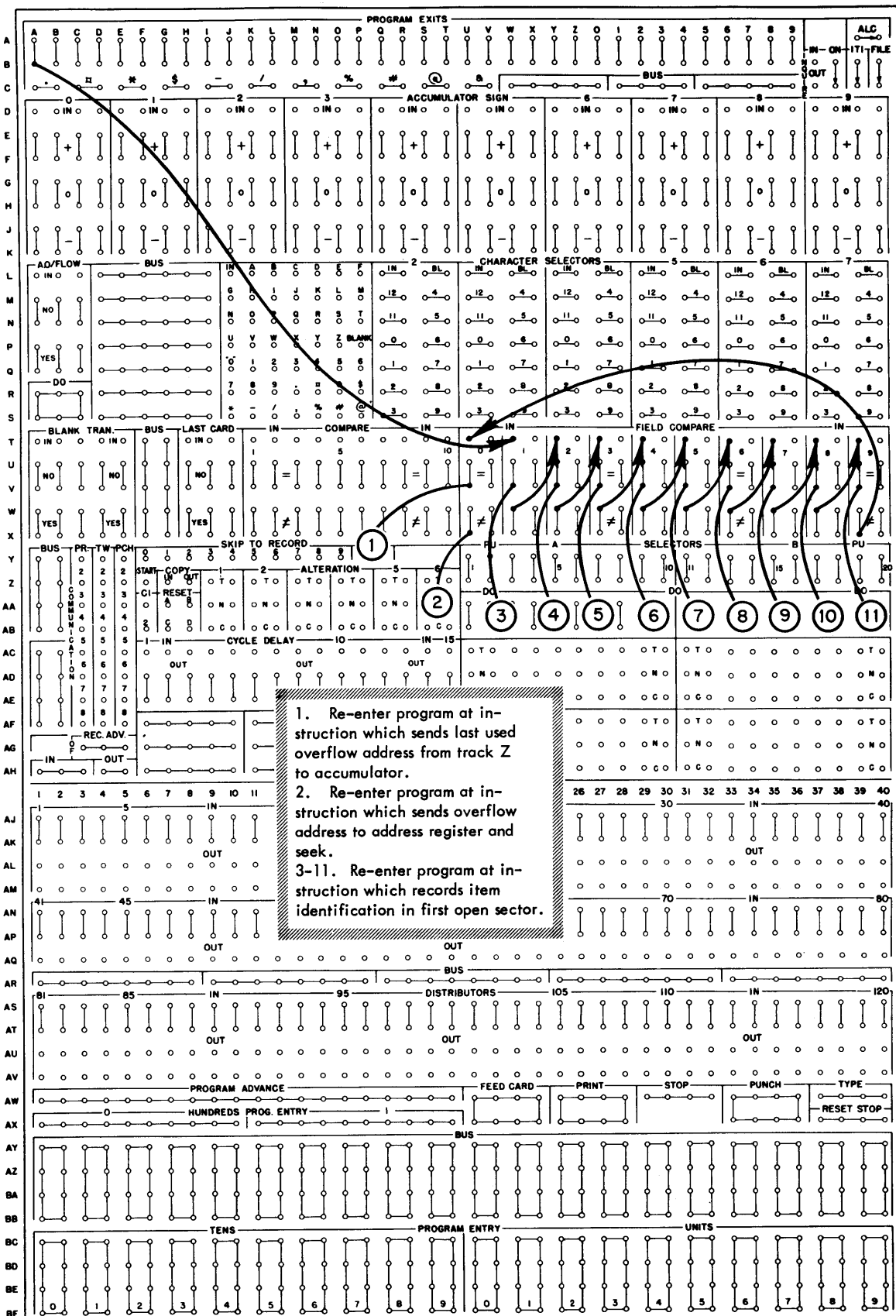

Figure 38. Wiring Diagram-Constructing an Index Record and Storing a Record (Part 1)

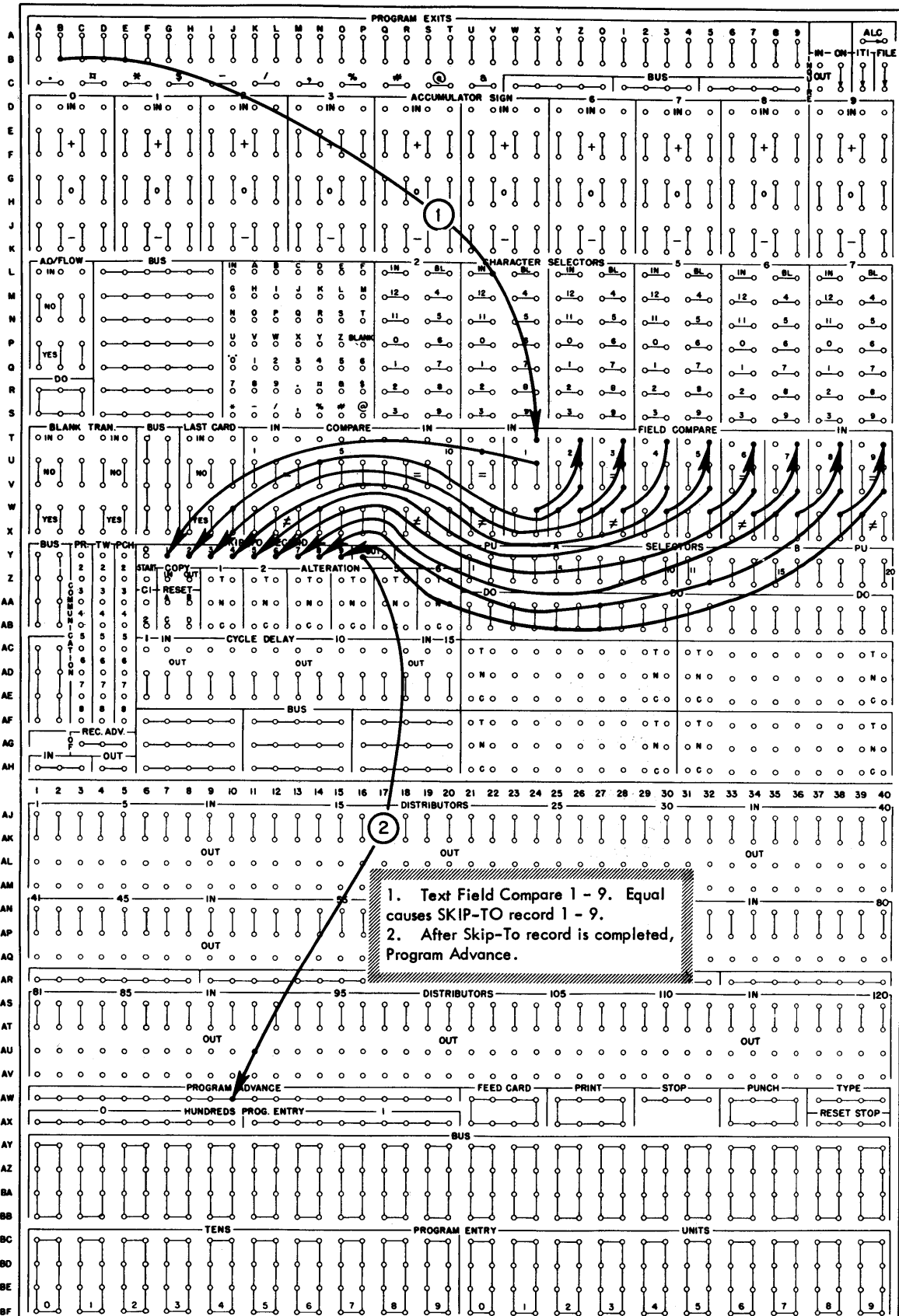

Figure 39. Wiring Diagram-Constructing an Index Record and Storing a Record (Part 2)

If, after testing the field compare selectors and all sectors are found to be filled, an overflow condition exists and the record must be stored on another track. The indirect address may be increased by 10, and an attempt made to store the record on the next track. Alternatively, the address of an overflow track may be recorded

in the zero index record. Although this method requires longer access time for overflow items, it results in easier file maintenance and is carried through in the program. The program is block diagrammed in Figure 37, and Figures 38 and 39 show the process control and panel wiring.

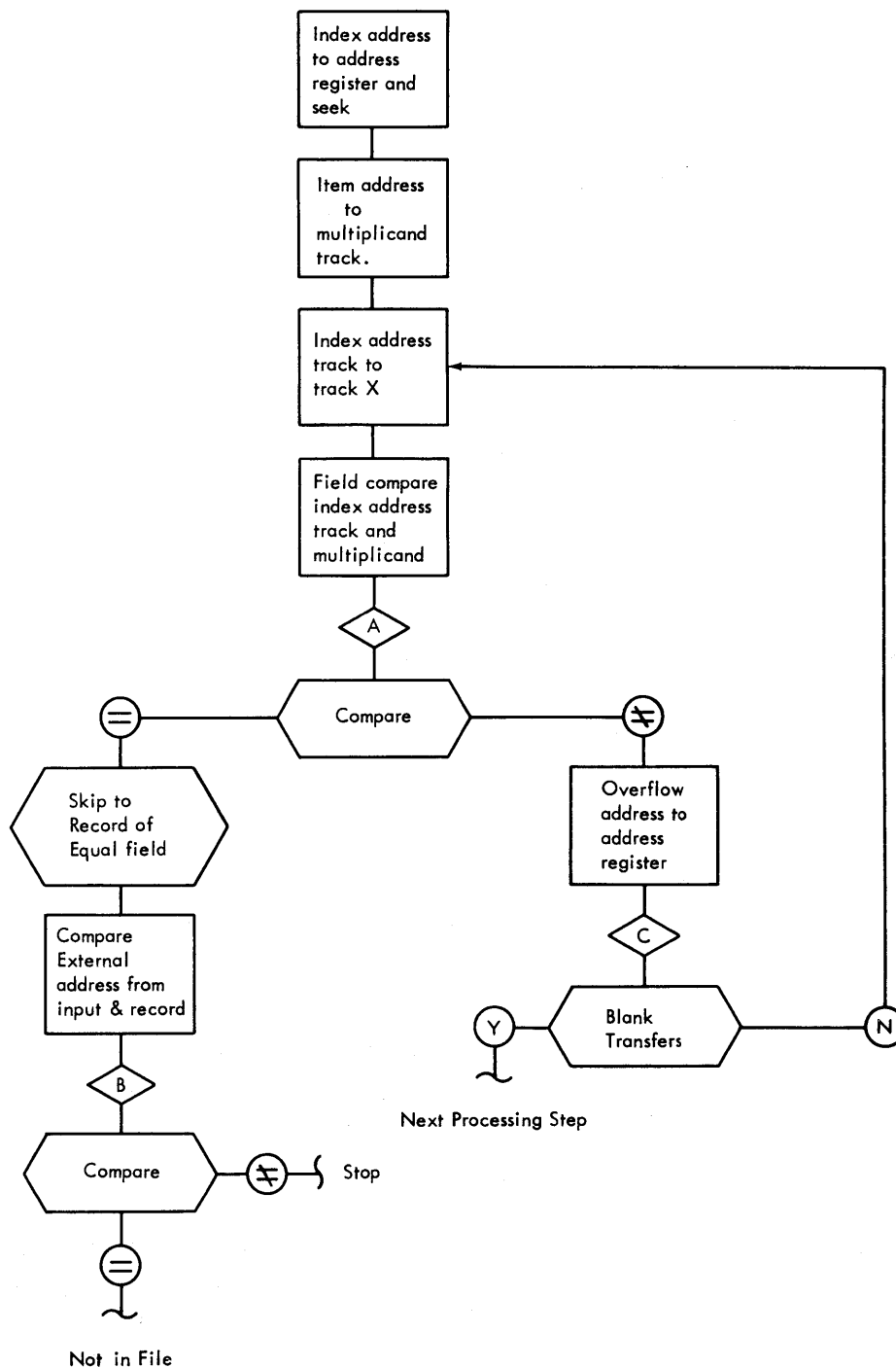

Figure 40. Locating a Record During Processing

LOCATING THE RECORD DURING PROCESSING (FIGURES 40 AND 41)

When the records are required for processing, a similar operation is performed. The external address is transferred to the random address and the index record is obtained from the disks. While the arm is moving to the location of the index record, the input address is sent to the multiplicand track, where it is written ten times in positions corresponding to the fields of the field-compare unit. When the index record is obtained, it is compared with the external address from the multiplicand track. If any field compares equal, the corresponding sector contains the desired record. The SKIP TO RECORD hub for that sector is impulsed, and the record is brought to the processing unit.

If none of the fields compare equal, the zero field is tested to determine if an overflow has been recorded. If an overflow address is present, it is sent to the address register, the zero index record is brought to the processing unit, scanned, and if an equal is found, the corresponding sector contains the desired record. If no equal is found, and there is no overflow address, the item is not recorded in storage, and the machine may be programmed to indicate this condition on the typewriter.

Chaining

Chaining is another method of organizing the RAMAC file and keeping track of overflow addresses. This method uses a five-digit address, as opposed to a four-digit address used with the index method.

When the system is first loaded by this method, each item attempts to load into its addressed location (part 1, Figure 42). If another item already occupies this location, the item is sent to the next vacant location and the address of this location is stored in the first location as an overflow address (part 2, Figure 42). If there should be a third item with this same address, it will try to go to the first location where it senses the overflow address, and it is then sent to the second record location which is also occupied and must now be sent to the next vacant location (part 3, Figure 42). The overflow address for the third location is stored in the second record.

With the chaining method, the file is loaded in two stages. In the first stage, each item is loaded only if there is no previous item in the selected location. In the second stage, all remaining items are assigned to overflow positions.

During processing, each item first goes to its initial address position. If another item is located here, a seek

is made to the overflow address stored in this record, and a second test is made to see if this is the correct record. This overflow searching continues until the correct item record is found. Figure 43 shows the block diagram for finding a record during processing using the chaining method.

In general, if the average number of synonyms developed by an addressing system is not excessive, the chaining method should be considered and compared against the index or other systems of file organization to determine the best method in terms of time and storage utilization.

Two factors will affect the number of overflow conditions in the chaining method; using a five-digit address instead of a four-digit address reduces the number of synonyms to approximately one-tenth the number arrived at with the index method, and loading the file with the highest activity items first, increases the possibility of finding an item on the first seek.

80-20 Rule of Activity

One of the prime considerations in the physical distribution or arrangement of records in the file is to reduce seek time. When a file is loaded, high activity items should be loaded first so that they will be assigned the prime positions while less active items will be more apt to fall into the overflow records. It has been found that in a majority of applications, 80% of all activity can be attributed to 20% of the records. For example, 20% of the items in an inventory will account for 80% of the business, or out of every 100 transactions, 80 will be for the 20% high activity items. This general occurrence is called the 80-20 rule of activity.

A procedure is outlined in Figures 44 and 45 to analyze a numbering scheme to determine how efficient it will be in distributing records through a file. The example outlines the procedure for the index method of file organization; however, the same procedure is applicable to the Chaining method by developing a five digit address and plotting overflows on the basis of each synonym instead of groups of nine synonyms.

1. Punch existing numbers into cards and convert the numbers to a 4 digit address on a Calculating Punch so that they are relatively evenly distributed. Do not aim for perfection in distribution. This is important, but other areas of file packing have as much or more effect on time and space utilization. The first additions and deletions to the existing

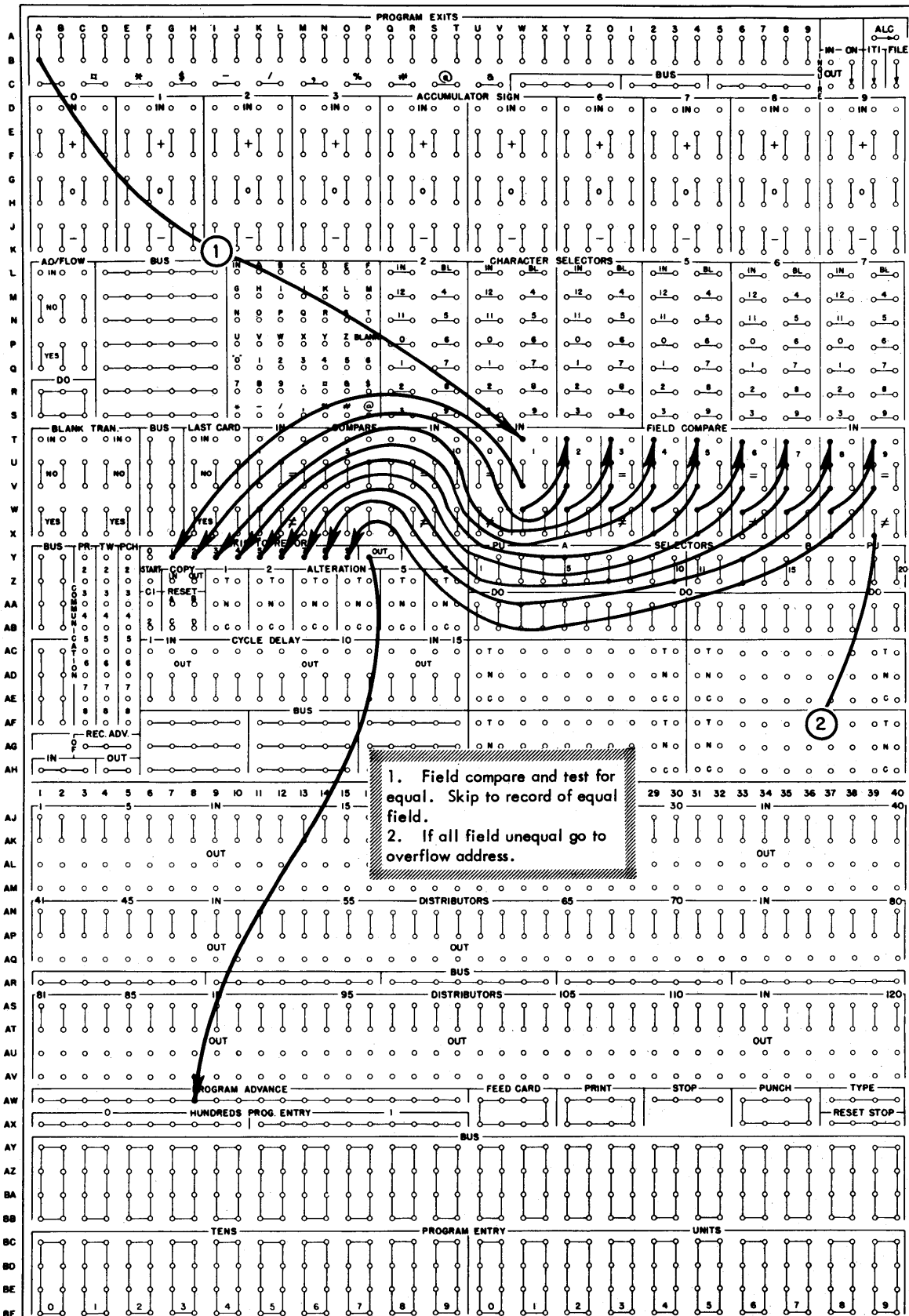

Figure 41. Locating a Record During Processing

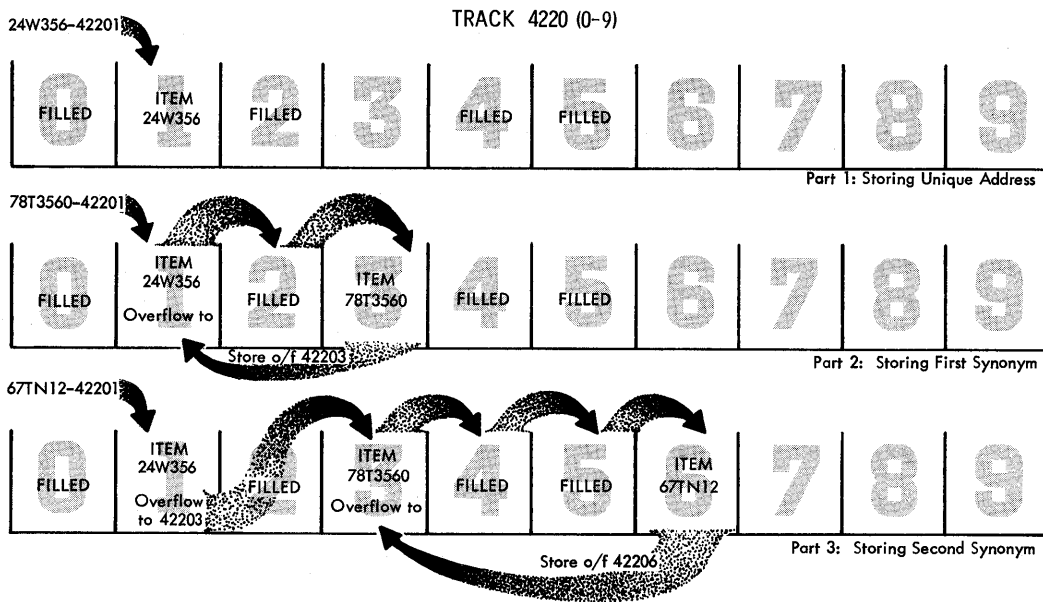

Figure 42. Chaining Method of Loading the File

file may change the distribution. Punch an X in the records representing the 20% highest activity.

2. Sort on Index or Address Number.
3. List the cards on an accounting machine and create summary cards with a count of synonyms.
4. Sort the summary cards by synonym count.
5. List the summary cards by count on an accounting machine (100% of file).
6. Sort the index cards on X to separate into 80% low activity (NX) and 20% high activity (X).
7. List the X cards on an accounting machine and create summary cards with a count of synonyms.
8. Sort the summary cards by count of synonyms.
9. List the summary cards of high activity by synonym count.
10. Plot a curve from the data in step 5 above (Figure 45). This curve indicates that approximately 60% of the records will be found in the first seek using an index method of file organization; 30% in two seeks; 10% in three seeks.
11. Plot a similar curve from the data in step 9 above. This curve indicates that if only the high activity records are considered, 95% of the items will be found in the first seek, and only 5% will require two seeks.
12. If the high activity items are loaded first, followed by the low activity items, the prime positions will

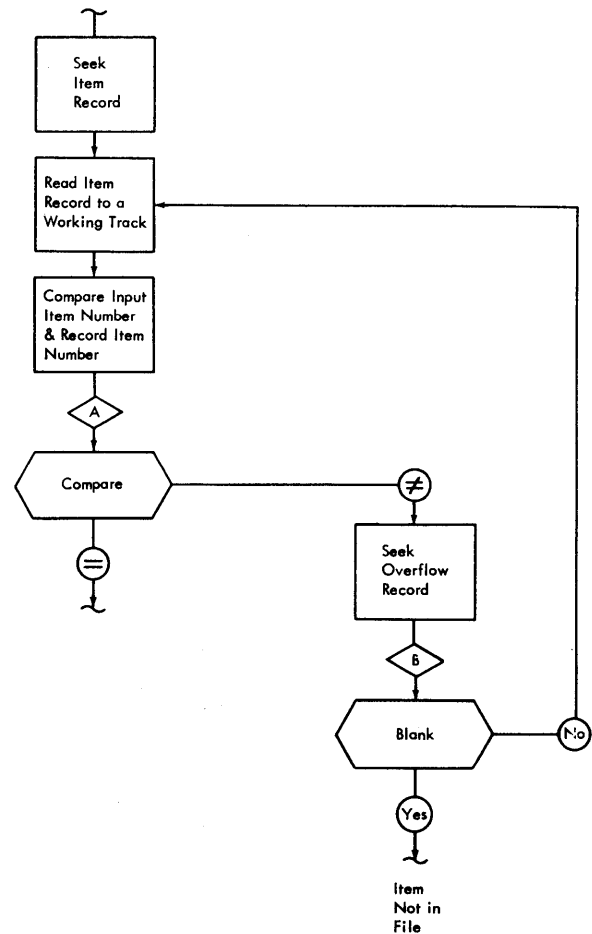

Figure 43. Chaining Method of Seeking a Record

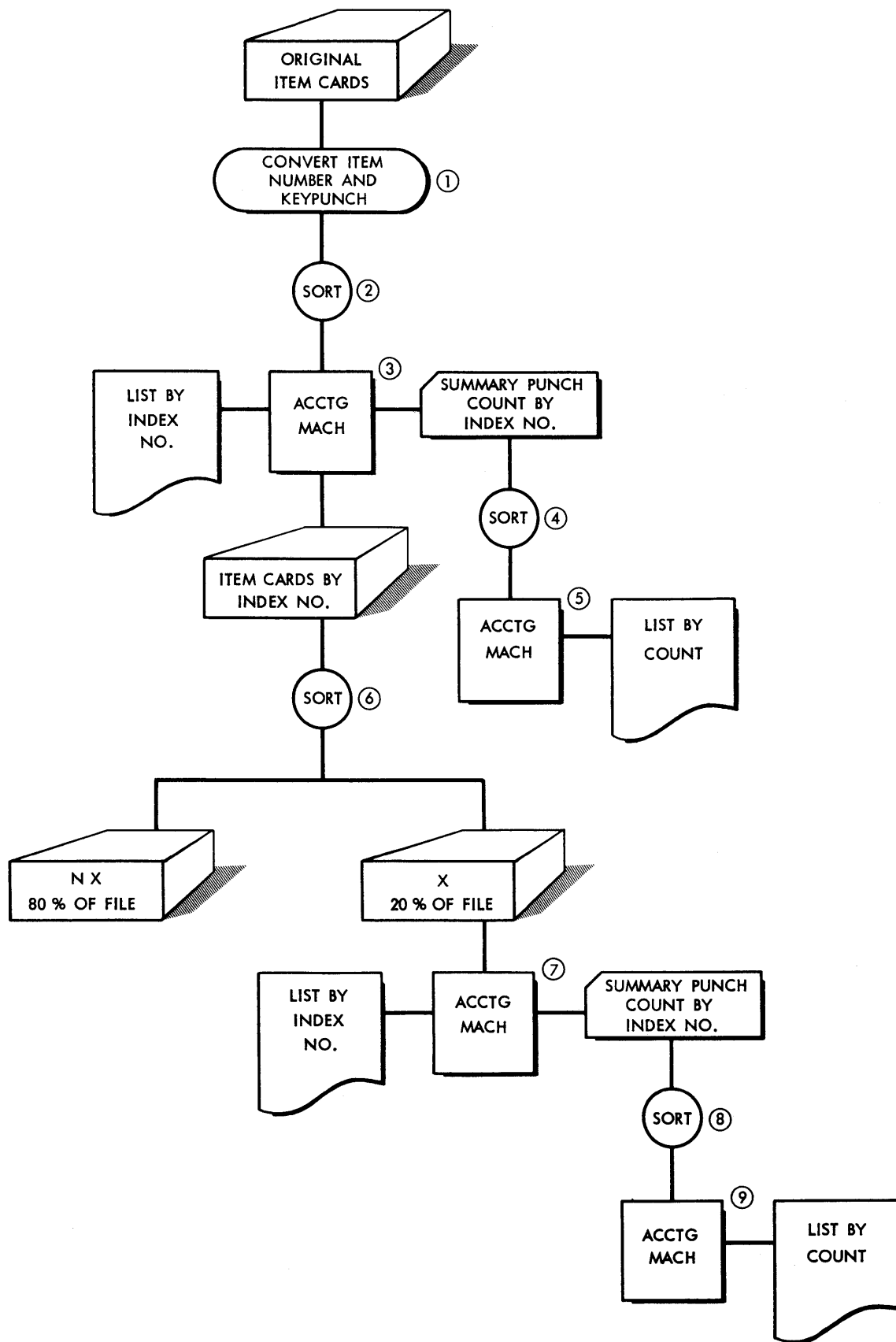

Figure 44. 80-20 Rule Procedure

be assigned to the active items and a distribution will occur similar to the last graph (Figure 45).

To see the effect of loading high activity items first, process 100 transactions against a file load as in step 10.

60% of 100 items @ 1 seek = 60 seeks

30% of 100 items @ 2 seeks = 60 seeks

10% of 100 items @ 3 seeks = 30 seeks

Total of 150 seeks

or an average of 1.5 seeks per record.

If the same 100 transactions are processed against the graph as in step 12, 80 of the items will be processed as

high activity items and 20 as low activity items. High activity

95% of 80 items @ 1 seek = 76 seeks

5% of 80 items @ 2 seeks = 8 seeks

Low activity

60% of 20 items @ 1 seek = 12 seeks

30% of 20 items @ 2 seeks = 12 seeks

10% of 20 items @ 3 seeks = 6 seeks

Total of 114 seeks

or an average of 1.14 seeks per record.

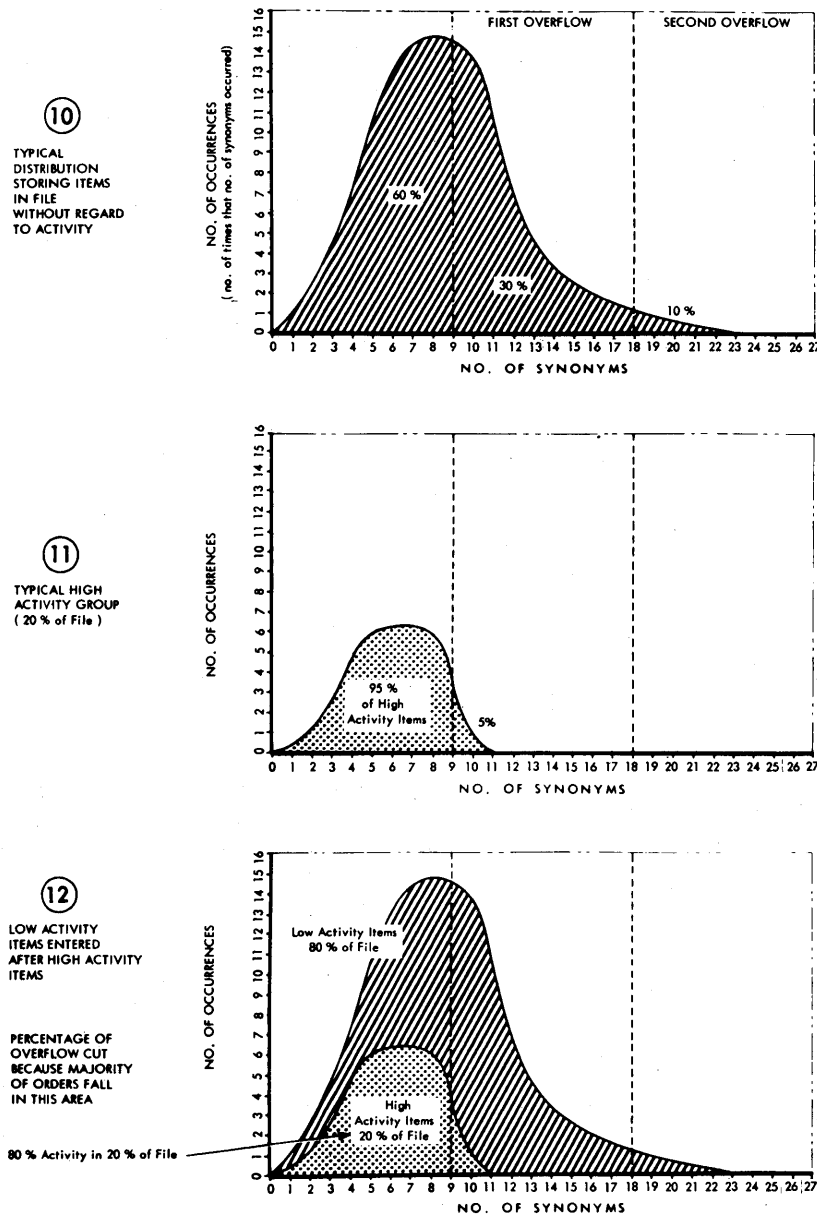

Figure 45. Typical Curves Obtained Using 80-20 Rule

Internal Checking

INTERNAL checking devices are built into the machine to monitor the transfers of information.

Character Coding System

Figure 46 shows the coding system used for recording information in IBM punched cards. Punching is done in two main areas in the card. The lower (numerical) section records the digits 0-9 and the upper section, used in combination with the numerical section, records alphabetic and special characters.

The numerical section is divided into ten horizontal rows, one row for each digit 0-9. The zone section is divided into three horizontal rows, 0, 11 and 12. The zero row is common to both zone and numerical sections. The digits are identified by single punches; the letters and special characters by combinations of zone punching with digits.

The 12-zone in combination with the digits 1-9 form the letters A-I, the 11-zone with the digits 1-9 form the letters J-R and the 0-zone with the digits 2-9 form the letters S-Z.

The method of coding these characters on the disk and drum tracks is also shown in Figure 46. Information is recorded on the disks by making a series of magnetic spots or *bits* in the ferrous oxide coating. The serial arrangement of bits forms letters, digits and special characters.

The recording area for a character is divided serially into three sections:

1. The zone section consists of the first two positions in the code pattern. The presence of a bit in both positions corresponds to a 12-zone punch in an IBM card. The presence of a bit in the first (0) position corresponds to a 0-zone in the card, and the presence of a bit in the second (X) position corresponds to an 11-zone punch.

2. The numerical section consists of four positions, which are serially assigned values of 1, 2, 4, and 8. Combinations of punches in this section correspond to numerical punches in the IBM card.

3. The check section consists of one position which receives a bit for those characters that would otherwise have an even number of bits. By filling this position with bits for all characters that would otherwise be even, all characters are coded with an odd number of bits.

As an example, the character J is coded on an IBM card with the combination of the 11-zone punch with the 1-digit punch. On the magnetic disk, the zone section is recorded with an X bit, and the numerical section has a bit recorded in the 1 position. Because an even number of bits results, the check position is filled with a magnetic spot to result in an odd number of bits (3) for the character. Similarly, the character T is coded by a combination of the 0 and 3 punches in an IBM card. On the disk it is recorded with a bit in the 0 position, bits in the 1 and 2 positions to represent 3, but no bit in the check position, because the code already has an odd number of bits.

The coding system shown in Figure 46 is used throughout the machine for magnetic recording on the disks and drum. As the information passes to and from the magnetic core unit on each transfer instruction, every character is checked for an odd number of bits. This type of checking is called a *parity* check. If a character is found with an even number of bits, it is recognized as an error.

Checking

The 305 is equipped with check indicators that provide the operator with a check on the accuracy of the information being processed by the machine. Check

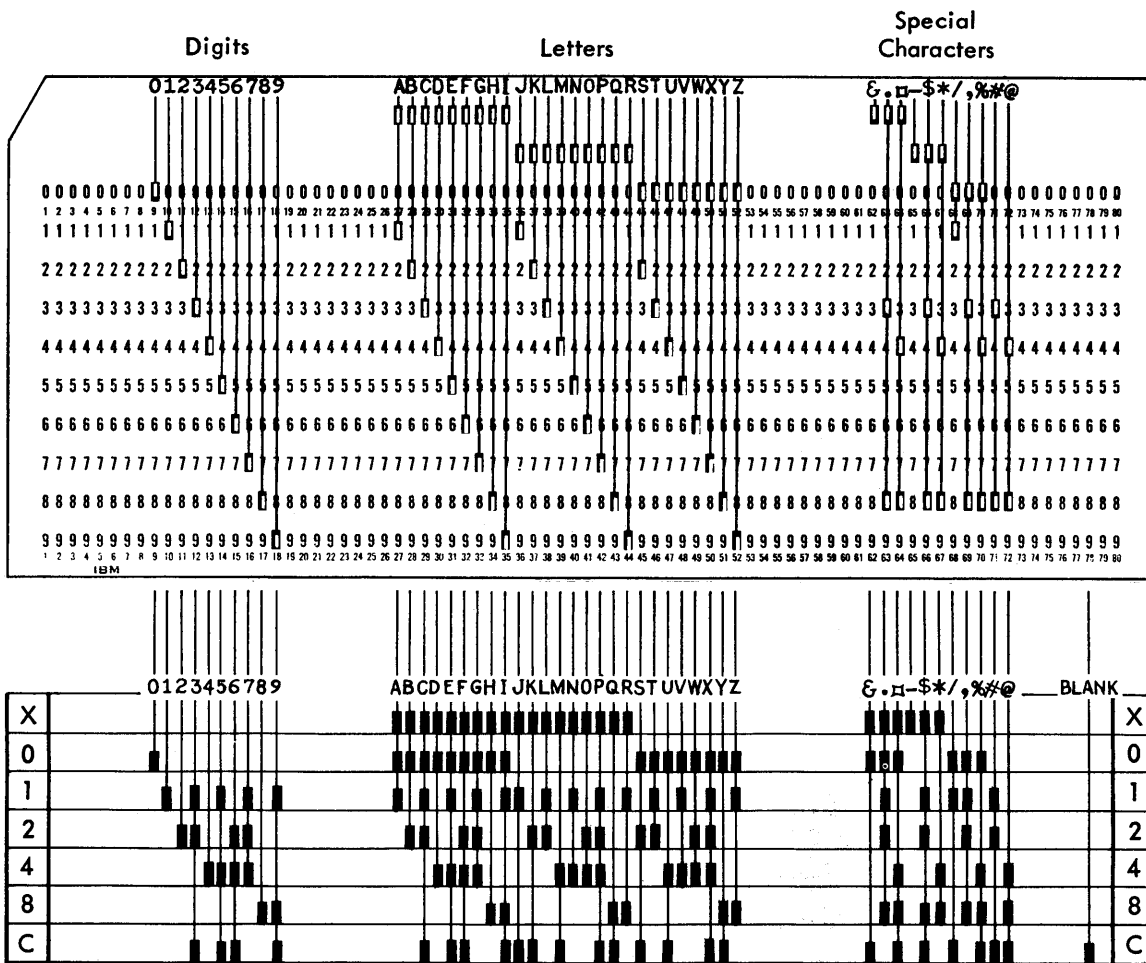

Figure 46. Character Coding for IBM Punched Card and IBM 305 RAMAC

lights are provided at the console as follows:

- Read Check
- Feed Check
- Parity
- File error
- Clock

READ CHECK

In the card reader, as each card passes the first reading station (Figure 47), it is read, coded from IBM card code to the RAMAC code used in the machine, and recorded on input track 1 on the processing drum. As the next card feed cycle begins, the characters on the input track 1 are read off and transferred to input track 2, and a check bit is added to any character that would otherwise have an even number of bits. Input track 1 is erased and the next card is recorded on it from first read-

ing. Meanwhile, the first card is passing second reading and this card is read again, decoded from IBM card code to machine code, and recorded on input track 3. A bit by bit comparison is then made between input track 2 and 3 (the check bit is disregarded). Any deviation between the two recordings stops the machine and turns on the Read Check light. A transfer *from* the input track is not possible if a Read Check error occurs. Thus, no information in error can be processed. If the two recordings are exactly the same, input track 2 is made available to the process unit. Restart procedures are covered under *Error Correction Procedures*.

FEED CHECK

If the reader fails to feed a card, the Feed Check light is turned on and the machine stops. The operator should determine the reason the card did not feed and restart the machine. Restart procedures are covered in a later section entitled *Error Correction Procedures*.

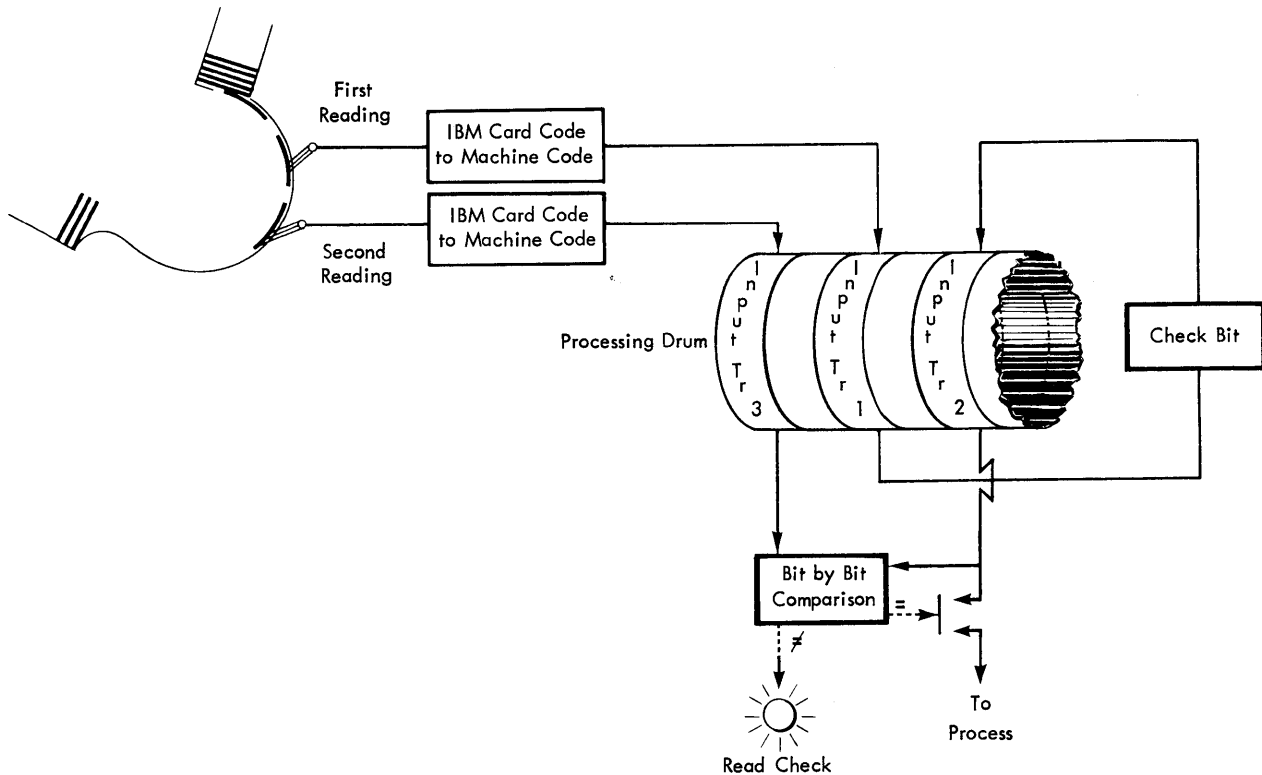

Figure 47. Checking of Input Card Reading

PARITY CHECK (FIGURE 48)

Each character that enters or leaves the magnetic-core unit is checked to insure that it contains an odd number of bits. This check is called a parity check. All data being processed in the machine will be checked for parity each time it is transferred because all information transfers take place through the magnetic-core unit. Any combination of bits that give an even count will stop the machine and turn on the Parity Check light. Restart procedures are covered under *Error Correction Procedures*.

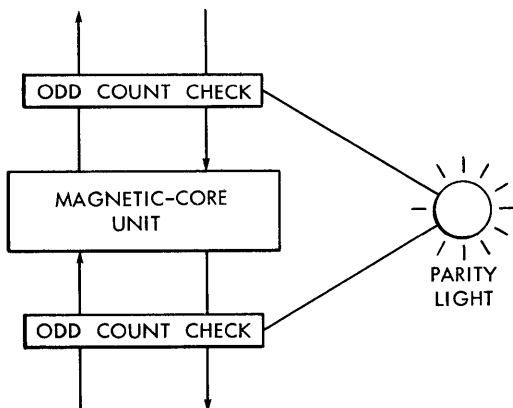

Figure 48. Parity Check

Parity checks are also made on the coded program instructions entering the address register, and on all information as it is transferred from the output track to the printer or punch.

FILE CHECK (FIGURE 49)

The file check is a check on the recording of information on the disks. When a record is written in the disk storage, the machine automatically rereads the original record into the core unit a second time. Then the record in disk storage is read back and compared, character by character, with the second reading of the record in the magnetic-core unit. A difference in comparison causes the File Check light to be turned on and the machine stops. This check is in addition to a parity check of the transferred data.

If information is transferred from the accumulator track to the disk storage on an accumulator readout and reset instruction, a file error stop occurs. Because the contents of the accumulators have been reset, the accumulators cannot be compared with the information on the disks.

If the File Interlock is not connected during program testing, there will be a File check light on every write operation because the contents of the disk track are not changed. The disk record, therefore, will not compare

with the sending track. This also serves to prevent processing the actual application without plugging the file interlock. File error correction is covered under *Error Correction Procedures*.

CLOCK

The machine makes an automatic check to determine that the timing control circuits are operating correctly. If these circuits are out of time, the Clock light is turned on and the machine stops. Clock error correction procedures are covered under *Error Correction Procedures*.

370 PRINTER OUTPUT CHECK

The 370 printer print stick is set up by a series of relays, one for each of the seven possible bits. As each character is set up for printing, a Parity Check is automatically made to insure that an odd number of print setup magnets have been setup. If a wrong setup should occur, the 370 Check light will be turned on. After the line is printed, the machine will print a Δ (delta) and stop or just print a Δ, depending upon control panel

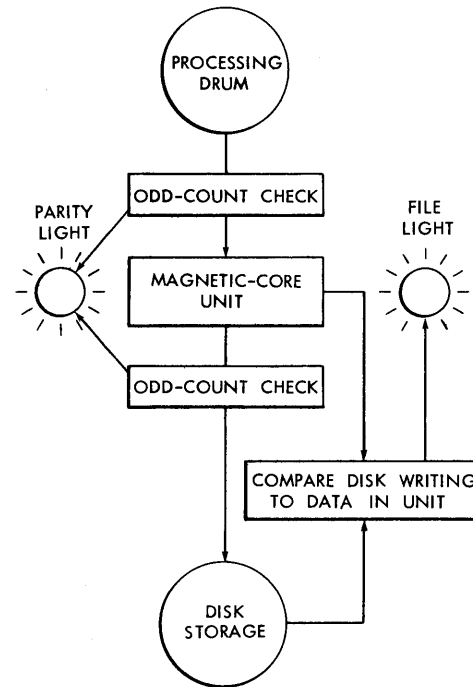

Figure 49. File Error Check

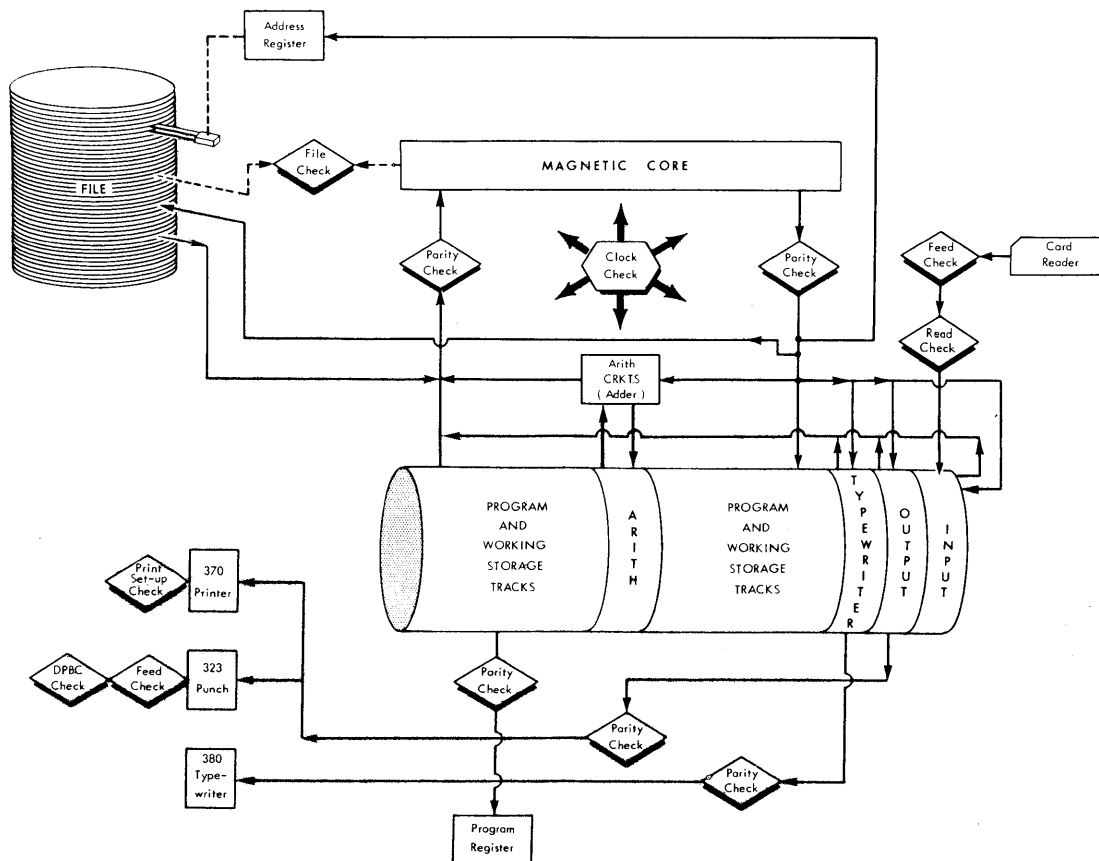

Figure 50. Summary of Automatic Machine Checks

wiring. The output check light will also be turned on if a parity error occurs between the output track and the printer.

323 PUNCH CHECKS

Associated with the 323 Punch are three checking features: Feed Check, Double Punch and Blank Column, and Parity. Any misfeed in the punch unit causes the Feed Check light to be turned on. It will also turn on when the hopper is empty or when the stacker is full. A

Double-Punch Blank Column light will be on when either a Double-Punch or Blank-Column error is detected, if the error exit is wired to stop on the punch control panel. The parity light will be on if any character being transferred from the output track to the punch (including those positions not being punched) fails to pass the parity checking requirements.

Figure 50 provides a summary of automatic machine checks.

380 Console

THE CONSOLE (Figure 51) provides manual or semi-automatic control over the machine. It contains an indicator panel, a keyboard, a card reader, and a typewriter with its associated control panel. It allows an operator to investigate the source of an error, and to restore operation. Inquiries can be made requesting information stored on the disks or processing drum. In addition, it provides a convenient method for testing new programs.

Card Reader

The card reader which is located at the console unit is a parallel-type card feed containing two reading stations of 80 reading brushes each. Cards are fed face-down, 9 edge first. The feed hopper holds up to 800 cards. When the cards have passed through the feed, they enter the stacker. The stacker holds approximately 1000 cards. The stacker may be emptied while the ma-

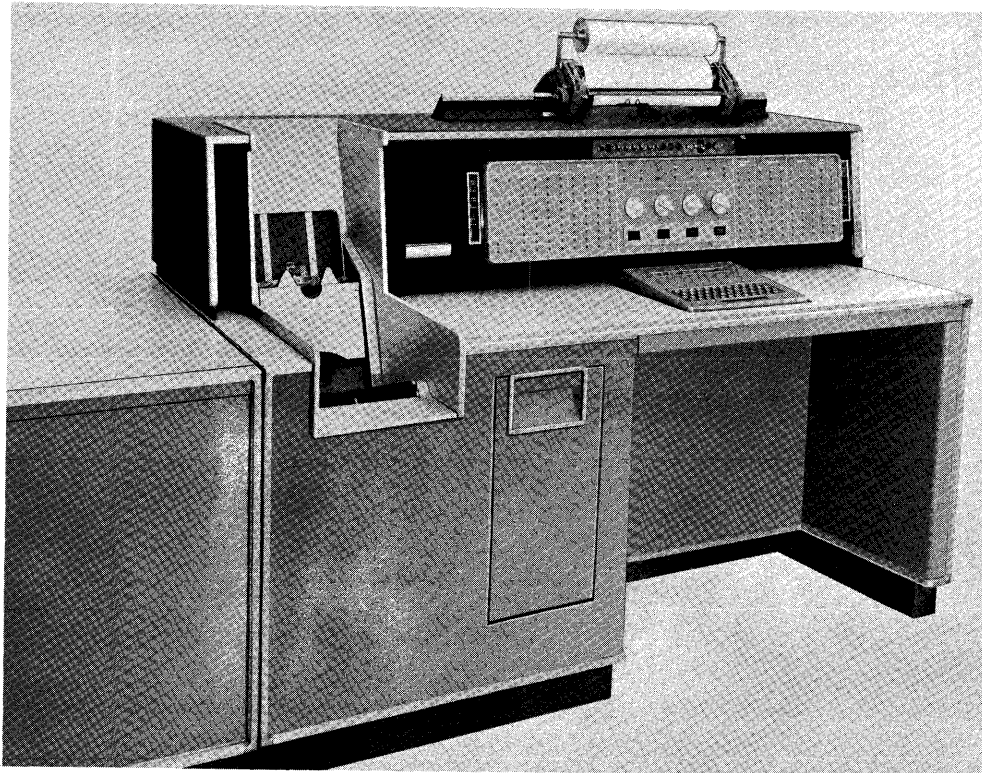

Figure 51. 380 Console

chine is in operation. A stacker stop switch is provided to stop the machine when the stacker is filled to capacity.

If the cards being read have mark-sense marks on them, the marking must be on the front of the cards. Otherwise, the electronic circuits used for card reading could detect the marks, and erroneous readings may result.

Control Keys

The following control keys are located on the console:

Master Power Off (Figure 52) This (pull type) switch is located to the right of the card reader. When it is used, all power is turned off immediately. It is for emergency purposes and should not be used as part of the normal power off procedure. (Note: A customer engineer must reset this switch if it has been used.)

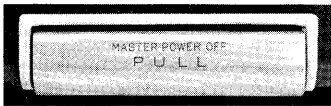

Figure 52. Master Power Off Switch

Power Off (Figure 53). When this key is depressed, the power is turned off; however, the blowers will remain in operation for a short period of time. This key is used instead of the master power-off to turn the power off under normal conditions.

DC Off. Depressing this key removes dc power from the system. This is desirable if the machine is to remain idle for an extended period of time.

Power On. By depressing this key, ac power is turned on to the system. It also restores dc power if the dc off key has been previously depressed.

Reset. When the reset key is depressed, the system is reset. It also resets clock errors (see *Error Correction Procedures*). It should not be used to reset Parity error and File Check indications and should not be depressed while a program is running.

After depression of the Reset key, the following conditions (console lights) will be indicated on the console panel:

1. Reset on.
2. Cycle Exit on.
3. Program Step-Hundreds "0" on.
4. Select-Reader.

NOTE: The reset key does not affect the accumulator, selectors, and other process control panel functions.

Reader Stop. The Reader Stop key stops the card reader immediately and removes the reader from a ready condition. The program continues running until the program attempts a transfer to or from the input track; then, the program stops. The Reader Stop key must be depressed prior to depressing the Non-Process Runout key to run cards out of the card reader without processing.

Reader Start. Depressing this key causes the reader to run cards into or out of the card reader. In addition, it restores the reader to a ready condition if the reader stop key has been previously depressed.

On the initial run-in of cards into the machine (provided the processing unit has been reset), one depression of this key causes: three cards to feed; the first card is checked and may be processed if all checks are satisfied; the start hub on the processing control panel emits an impulse.

Non-Process Runout. When this key is depressed, cards feed out of the card reader without being processed. It is generally used after a read check or a feed check stop. The non-process runout key is inactive unless the reader stop key has been previously depressed and the feed hopper is empty.

Program Start (Figure 54). This key starts the program at the next detail operating cycle if the program is stopped. Examples of its use are covered under *Control Selector, Program Selector, and Program Set*.

Check Reset. This key resets parity errors. Depressing it restores the error detecting circuits and leaves the machine ready to repeat the instruction on which the error was made. Check reset should not be depressed while a program is running.

Program Set. Depressing this key sets the program to the operating step set on the program selector switches. The instruction set up in this manner will not be executed until the program start key is depressed.

Program Stop. Depressing this key stops the program prior to the execution of the next program step. The next program step is then ready to be executed as soon as the program start key is depressed.

Control Switches

The following control switches are located on the console.

Alteration Switches (Figure 55). Six toggle switches are provided so that control panel operations may be altered by the switches without removing the control panel from the machine. The switches are connected to



Figure 53. Power, Reset and Reader Keys

control panel hubs on the process control panel, and are represented in the same manner as selectors (C-N-T).

K Test-K Run. The K Test-K Run switch is associated with input tracks K2 and K3. A console keyboard inquiry involving the K track functions as follows:

1. If the switch is set on K Test, the K3 track may be investigated by depressing Read and character key K on the console keyboard providing the machine is reset.
2. If the switch is set on K Run, the K2 track may be investigated by depressing Read, and character key K on the console keyboard providing the machine is reset.

For normal operation, the switch should be set to K Run. If an attempt is made to feed input cards into the machine with the switch set at K Test, a Read Check error stop will occur on each feed cycle.

Control Selector Switch. This is a five-position switch that sets the mode of operation for the machine. This switch may be turned while the machine is running to select a different mode of operation. The five modes of operation are:

1. *Program Run* allows the machine to proceed automatically. The operation is under complete control of the process control panel and the stored program.
2. *Control Stop* causes the machine to stop prior to the execution of the program step that has been set up on the program selector switches. For example, if program 159 is set up on the program selector switches, the machine will stop just prior to the execution of program step 159.

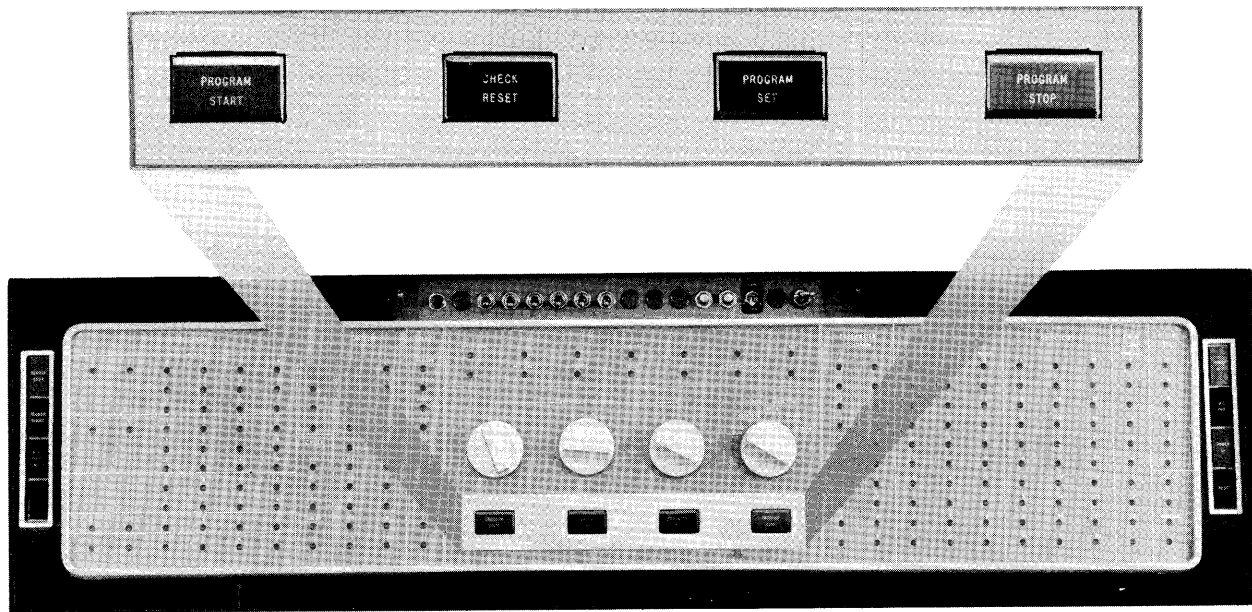

Figure 54. Program Keys

3. *Single Operation* allows the machine to proceed through one complete instruction each time the program start key is depressed.

4. *Single Cycle* allows the operator to step through each program step, one cycle at a time. For example, when the machine is in a single-cycle mode of operation, one depression of the program start key executes the INSTRUCTION cycle only. Another depression executes the FROM cycle, etc.

5. *Format Test* allows the program start key to control the mode of operation so that the typewriter may be stepped through one typing cycle at a time to test the console control panel.

Program Selector Switches. The switches correspond to the hundreds, tens, and units positions of the program. Depressing the program set key sets the program counter to the step shown on the switches. When the control selector switch is set to CONTROL STOP, the program stops before execution of the step indicated by the switches.

Control Buttons

The following control buttons (Figure 55) are located under a cover at the top of the console indicator panel.

Control Impulse. Two pushbuttons are provided. They cause impulses to be emitted from two hubs labeled CI on the process control panel. These impulses are normally used to pick up or drop out selectors.

Program Load. Program load starts the set up of a new program on the machine. Before this button is used, the machine must be reset and cards must be in the reader hopper. When these conditions are satisfied, depressing this button causes the following:

1. Cards will feed into the reader,
2. After the first card has been checked, the card information will be automatically copied (written) onto program track I,
3. An impulse will be emitted from the COPY OUT hub on the process control panel which may be wired to select the beginning program step of the program load routine on track I.

Test Lock (Figure 55)

Under normal operation (test lock off), the keyboard may be used only for making inquiries and correcting parity errors. No keyboard changes to the processing tracks are possible when this switch is off. When the switch is on as during program testing, it is possible to change data on the tracks of the processing drum. File records cannot be changed from the keyboard under either condition.

Indicator Lights

Power On (Figure 56). This light is on when power is supplied to the machine after depressing the power-on key.

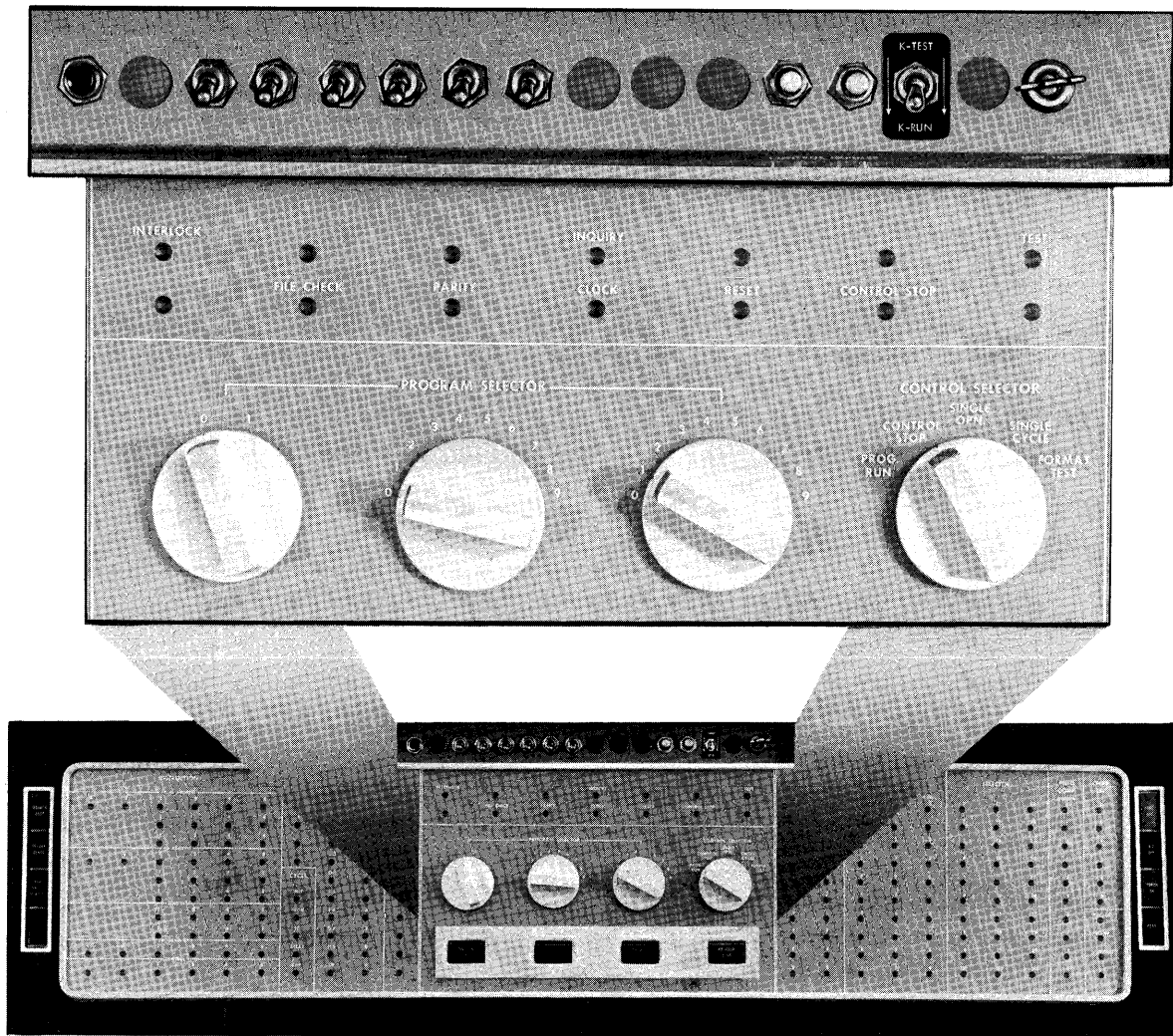

Figure 55. Control Switches, Buttons and Lights

DC On. This indicator light is on when dc power is being supplied to the machine circuits.

Stop. This light will be on any time the system stops. It is an indication to the operator that processing has been halted, but does not indicate the exact cause for stopping. In the event of an error, the cause will be shown on one or more of the other indicator lights.

Reader Power. This light is on when the reader has power supplied.

Reader Ready. The reader ready light will come on when the reader is under the control of the process unit. That is, no coding or card feed errors have been detected, and a checked card has been made available to the process unit.

Read Check. This light comes on when a comparing error is detected in the card reader. A failure either to read correctly or recode properly will stop the reader

immediately so that incorrect information will not be transferred to the process unit. Restart procedures are explained in a later section, *Error Correction Procedures*.

Feed Check. This light signifies a misfeed in the card reader. Restart procedures are explained in a later section, *Error Correction Procedures*.

Program Step (Figure 57). This bank of lights shows the number of the program step that is being executed. For example, program step number 127 would have the 1-B2-7 lights glowing. It can further be seen that program step 127 is actually on track B. The alphabetic track references are used when the program steps illustrated are 100 through 199. For steps below 100, the tens position of the step number defines the program track.

Instruction Lights. Any instruction, as it is being executed, will appear at this bank of lights in coded form. When the machine is being operated in the single-cycle

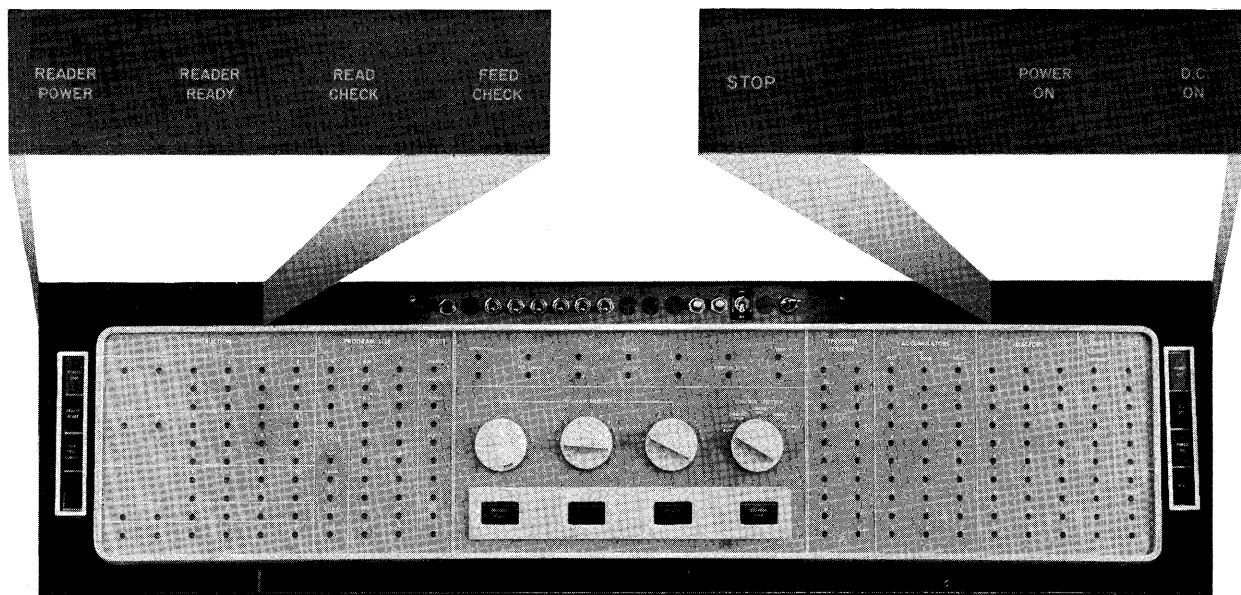

Figure 56. Power, Machine Stop and Reader Lights

or single-operation mode, these lights may be investigated to determine if the instruction is correct. The FROM address, TO address, and the PROGRAM EXIT are represented in machine code, that is, an A would light the X, 0, and 1 neons. The LENGTH, and CONTROL banks are in straight binary form, that is, a 5 would light the 1 and 4 neons, etc.

Cycle. These five lights show the cycle of the instruction that will be executed next unless an error has occurred. If an error is indicated, the lights show the cycle on which the error occurred. When the machine is in a single-cycle mode of operation, an operator may step through an instruction one cycle at a time using these lights as a convenient means of keeping track of each cycle of the instruction. In order of occurrence, the cycles are INSTRUCTION, FROM, TO, DELAY and EXIT. DELAY and EXIT occur when the ninth position of an instruction contains either a digit, special character, or an alphabetic character or on any cycle delay, record-advance, skip-to-record or seek instruction.

Typewriter Column (Figure 58). These lights indicate the column of the typewriter track (Q) that is to be written on, or the Q-track position to be typed if the typewriter is typing a record.

Accumulator Signs. The sign of each accumulator is represented here; plus, zero, or minus. At the completion of a multiplication, the sign lights of accumulators 0 and 1 are always plus even if the accumulators are zero.

Selectors. An indicator light is associated with each selector. When the selector is transferred, the light is turned on. It will remain on until the selector is dropped out.

Field Comp. Each field-compare light will come on if its respective field is unequal as a result of a field comparison.

Char. Sel. When a character is transferred to the character selector, these lights indicate its identity in RAMAC coded form. The lights will retain their setting until another character is transferred to the character selector.

Acc. Of. If this light is on, one of the accumulators has had an overflow. It will remain on until the selector is dropped out by control panel wiring.

Blank. This light indicates that the last instruction programmed for blank column detection transferred all blanks or all zeros, and the Blank Transmission selector is in a YES condition.

Unequal. This light will come on if the last programmed compare was unequal. It will stay on until another comparison changes it. It indicates the status of the compare selectors on the process control panel.

LC. This light indicates that the last card selector has transferred to a YES condition.

Select (Figure 59). A row of lights is provided to indicate when a particular unit is operating. As each unit is selected, the associated light will come on and will remain on throughout its operation. If a selected

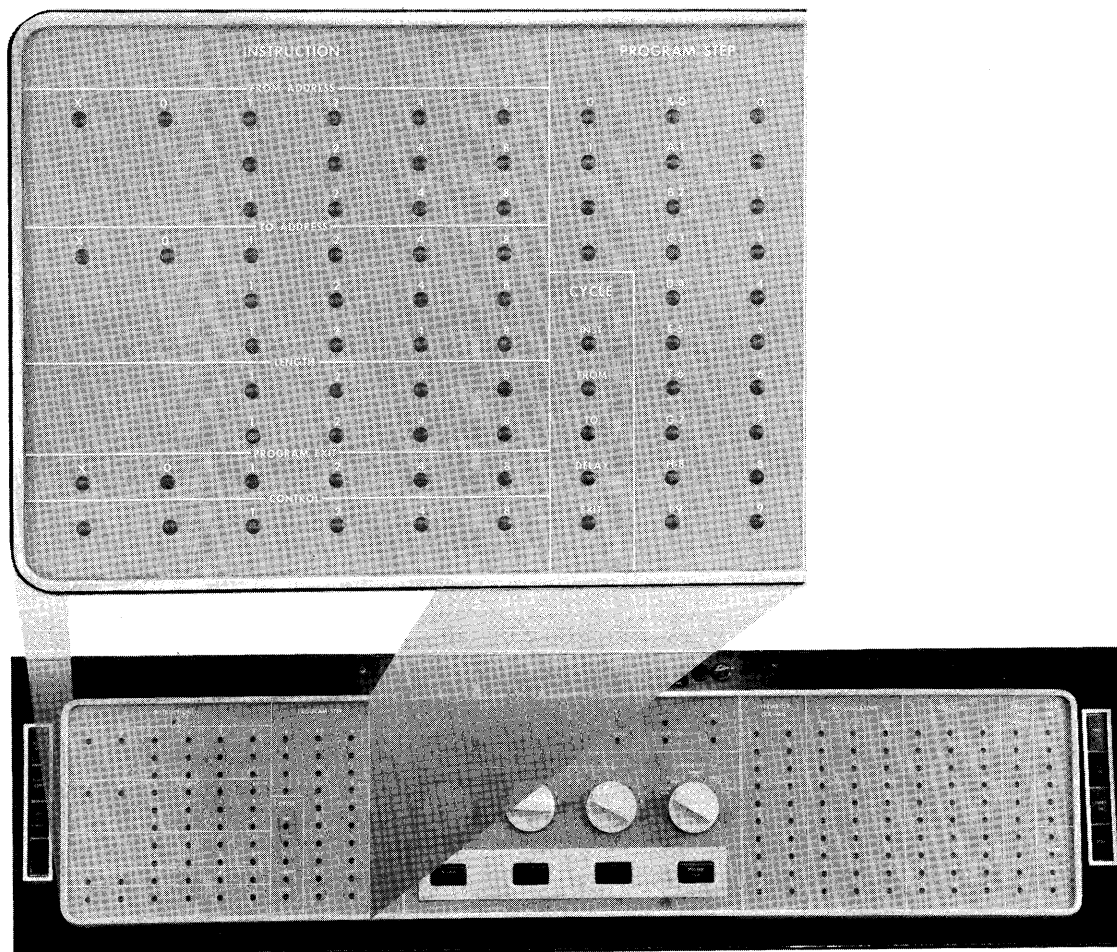

Figure 57. Program Instruction Lights

unit should fail to complete an operation, the light will stay on. This bank of lights includes reader, printer, punch, typewriter and access.

Interlock. The interlock light will be turned on whenever processing has been stopped because a selected unit has not completed its operation. The light will turn on if the program attempts to:

1. Transfer information to the punch, printer, or typewriter tracks, or the access unit, if any of these units has been previously selected and has not completed its operation.
2. Transfer information to or from the input track if the reader has been previously selected and has not completed its operation.
3. Read or write on the file prior to the access unit arriving at its address.

Inquiry. This light will glow when the machine will allow a manual inquiry. Manual inquiries are covered

in a later section, *Inquiries*.

Test. This light will glow when the test lock is on.

File Check. Each time a record is written into the disk storage, it is automatically read back and compared against the source record. If the record is stored correctly, the machine will proceed with its operation. However, if the readback from the disk does not compare, the machine will stop and the file light will be turned on. Correction procedures are covered in a later section, *Error Correction Procedures*.

Parity. This light is turned on whenever the machine detects a parity error during a transfer. The program will stop. Restart procedures are covered in a later section, *Error Correction Procedures*.

Clock. The machine makes an internal check to insure that the timing circuits are operating properly. If these circuits fail, the machine will stop and the clock light will come on indicating a possible error. The light may be turned off by depressing the reset key. Techniques for

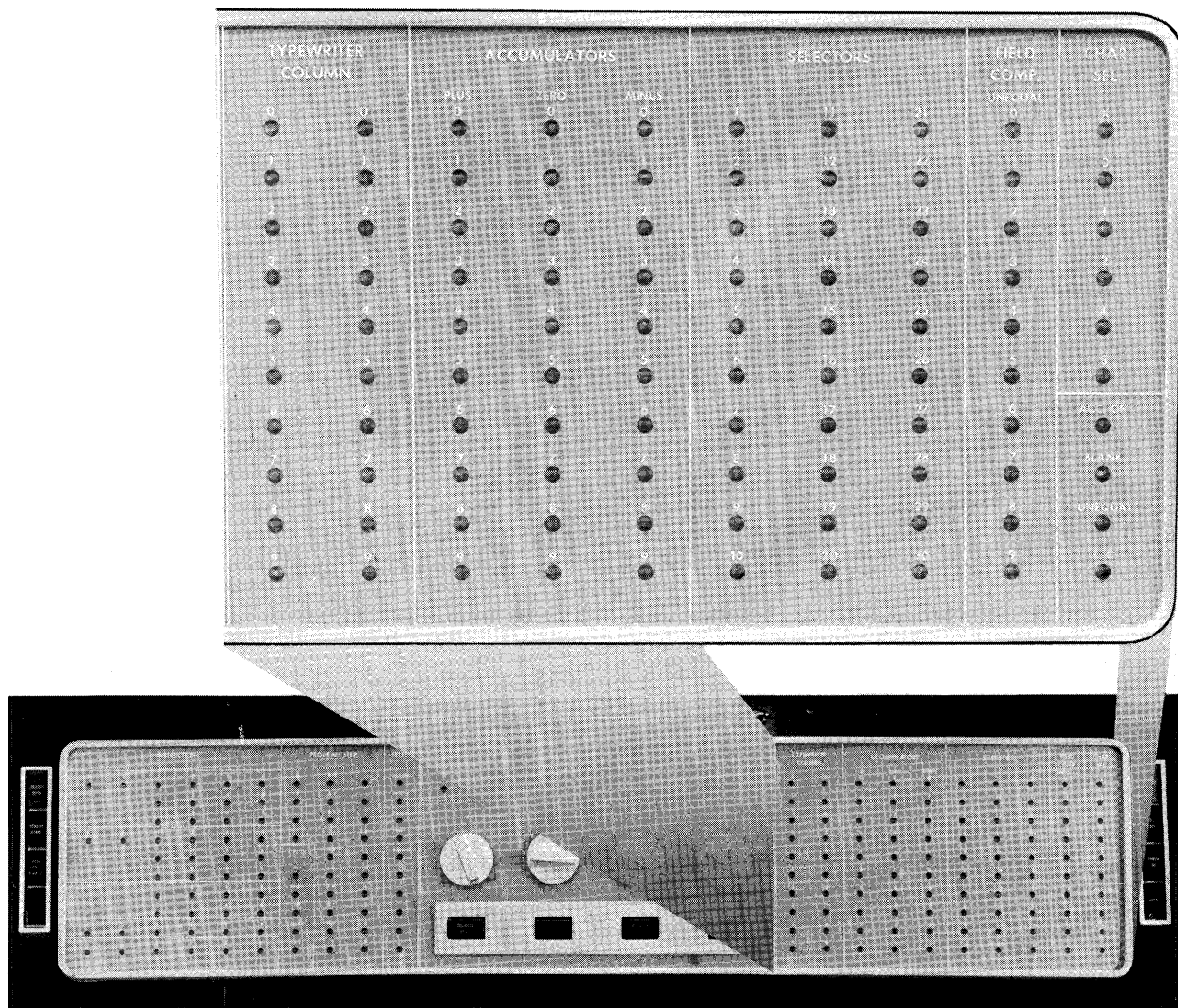

Figure 58. Typewriter and Process Control Panel Status Lights

clock error correction are covered in a later section, *Error Correction Procedures*.

Reset. This light indicates that the system is reset.

Control Stop. This light will come on and the machine will stop when the hubs labeled STOP on the process control panel are impulsed, when the control selector switch is placed on SINGLE OPN. or SINGLE CYCLE, when the machine stops after a control stop, or when the program stop key is depressed. Operation may be resumed by depressing the program start key.

Keyboard Functions

The keyboard (Figure 60) on the console is similar to that found on a typewriter. It is used to make inquiries, and to write or make corrections on the processing drum

tracks. It cannot be used to directly change disk storage records.

Format Keys. There are three format keys: 1, 2, and 3. When any one of these keys is depressed, it is a signal to the machine that the operator wishes to make an inquiry to the file. With each key there is a corresponding control panel hub on the typewriter control panel. By appropriate wiring, different document formats are possible when making inquiries. For example, depressing format 1 can initiate a typewriter format routine which may be entirely different from the format called for when format 2 is depressed. Inquiry procedures are explained in a later section, *Console Operating Procedures*.

Read Key. Depressing this key will condition the machine so that a track record can be typed by depressing the alphabetic or numerical key corresponding to its track

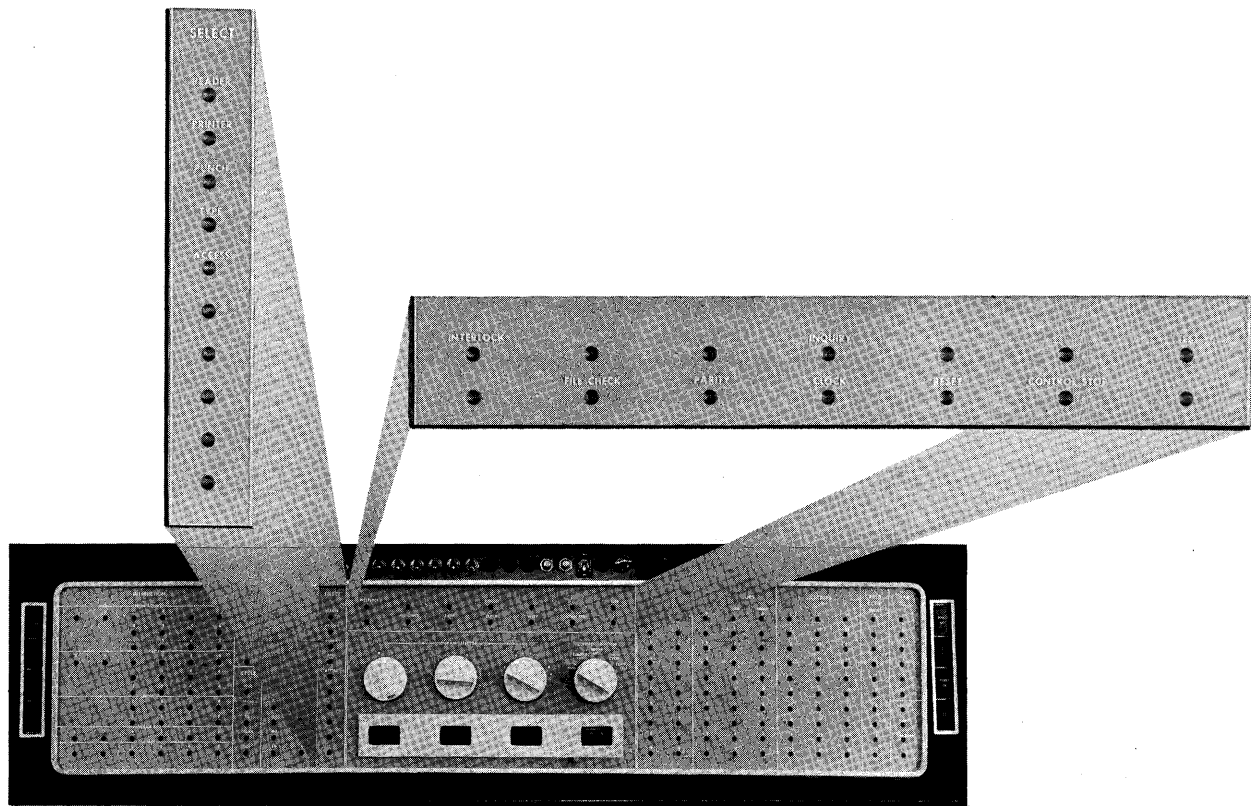

Figure 59. Error Correction and Control Lights

address. It should not be depressed while the program is running or the machine is interlocked.

Alter Key. Depressing this key (if the test lock is on) will condition the machine so that information can be recorded on the typewriter track from the keyboard. If the test lock is off, depressing the key will cause the typewriter to space to the characters having a parity error on the Q-track and stop for their correction. It should not be depressed while the machine is processing or interlocked.

Write Key. Depressing this key will condition the machine so that data may be transferred from the typewriter track to some other drum track. If the test lock is off, data on the typewriter track will automatically be returned to the track from which it originated. When the test lock is on, the operator must depress a track key (one of the character keys) to send the Q-track information to the desired track. It is not possible to transfer data directly to disk storage. The machine should not be interlocked, and processing should be stopped before depressing this key.

Figure 61 illustrates the use of the Read, Write, and Alter keys as they affect track A. The same operation is applicable to all drum tracks.

Clear Key. When this key is depressed, typing will stop; the carriage will return; and the keyboard will be restored. This key has no effect on the data recorded on the Q track.

Character Keys. These keys are used for recording data on the typewriter track or specifying a track address.

Dup Key (Duplicate Key). Constant depression of this key will automatically cause the typewriter to type the contents of the Q-track if the test lock is on and the alter key has been previously depressed. This allows the operator to automatically duplicate portions of a record on the Q track when it is being altered. This key is inoperative if the test lock is off and the later key has not been depressed.

Carr. Ret. Depressing this key will cause the carriage to return.

Space Bar. If the test lock is on and the Alter key has been previously depressed, the space bar will clear (write space bits) one position of the Q track with each depression of the space bar. If the Read key is depressed, followed by a single depression of the Space bar, the entire Q track is cleared regardless of the setting of the test lock.

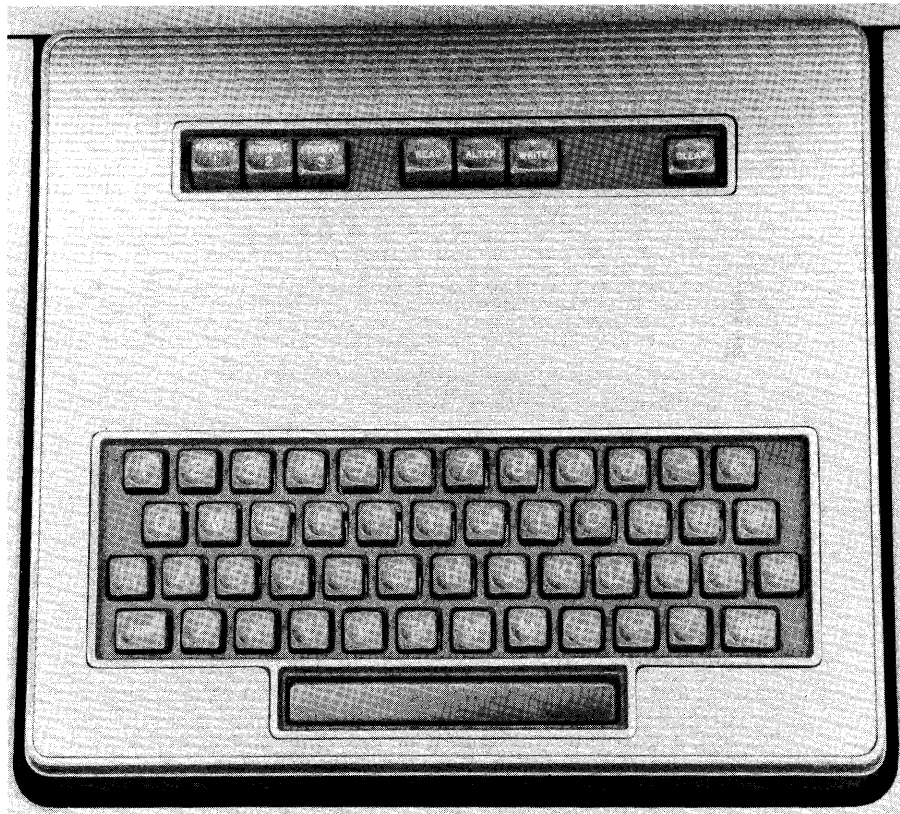
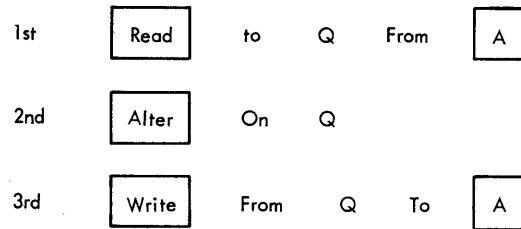

Figure 60. Console Keyboard

Test Lock On



Test Lock Off

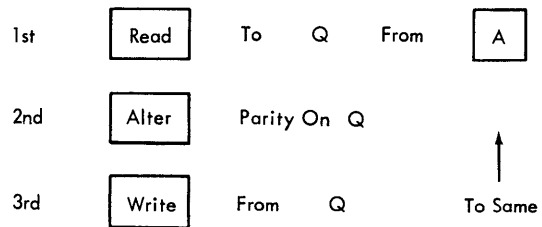

Figure 61. Read, Write, and Alter Operation

Console Operating Procedures

THE FOLLOWING EXAMPLES of the use of the console are presented as an aid to the operator. The examples include start and stop procedures, inquiries, drum track alterations, and testing procedures.

START-STOP PROCEDURES

THE FOLLOWING procedures may be used for starting and stopping the RAMAC system.

Starting the Machine After a Power-Off Condition

The following procedure may be used to start the machine after the power has been turned off:

1. Depress the Power-on key at the console. This turns power on to all units (printer and punch power switches may be left on). If the Power-off key was depressed to turn machine power off, approximately two minutes are required for the system to turn on in sequence. At the end of this time, a number of the console display lights will be on, indicating that DC power is being supplied. After the console lights have turned on, depress the Reset key.

NOTE: If only DC power was removed (by depressing DC OFF), the console lights will turn on immediately after depressing the Power-on key.

2. Depress the printer Start key. Check to see that the printer Ready light comes on to indicate that the printer is in a ready condition.
3. Hold the punch Start key down until cards stop feeding and the Ready light is on.
4. Depress any Control Impulse buttons that are required by the program.
5. Place the Control Selector switch to the desired mode of operation.

6. Place the desired data or program load cards in the reader hopper.
7. If a new program is to be loaded, depress the Program Load button. If the program is already in the machine, depress the reader Start key.

NOTE: The Power-off key should not be depressed until approximately one minute has elapsed after depressing the Power-on key. If it is depressed before this time, the following procedure should be used to re-establish power to the system:

1. Depress Power-on — wait one minute.
2. Depress Power-off.
3. Depress Power-on to resume normal operation.

Restarting the Same Job

It is only necessary to place cards in the feed and depress the reader start key to restart the same job. This will feed cards and start processing provided the machine is reset. The machine will be reset if the last card program routine is terminated by impulsing the RESET STOP hub on the process control panel or the Reset key is depressed.

Starting or Stopping at a Specific Program Step

To Start:

1. Set the Program Selector switches to the desired program step.
2. Set the Control Selector switch to the desired mode of operation — RUN, SINGLE OPERATION, etc.
3. Depress the Program Set key.
4. Depress Program Start.

To Stop:

1. Set the Program Selector switch to the desired program step.

2. Set the Control Selector switch to CONTROL STOP. The program will stop before executing the FROM cycle. That is, the program step will be set up but will not have been executed.

INQUIRIES

THE FOLLOWING procedures may be used when making keyboard inquiries.

Inquiries — File Information When Not Processing

1. The Test Lock must be off.
2. The machine must be reset — depress Reset.
3. Depress the desired Format key.
4. Key in the desired five-digit address.

NOTE: The machine will stay in a reset condition and additional inquiries may be made by repeating steps 3 and 4 above. If a Format key has been depressed and it is decided that the inquiry is not desired (e.g., wrong Format key depressed or wrong address keyed in), the console may be returned to its original status by depressing the Clear key.

Inquiries — File Information During Processing

ITI Off:

1. Test Lock must be off.
2. Control Selector switch should be set to RUN.
3. Depress the desired Format key.
4. Inquire light comes on immediately.
5. Key in the record address*. After the fifth key of the address is depressed, the typewriter will tab to the first tab stop and the Inquire IN hub is made receptive for an inquiry test. When a program exit tests the Inquiry IN hub, the program will be momentarily stopped, the access arm will seek the desired record, the record will be transferred to the Q track, and the typewriter will begin to type the record under control of the Console Control Panel. As soon as typing begins, the Inquiry OUT hub will emit an impulse which may be wired to restart the program.

ITI On:

If it is desired to use the typewriter as an output unit under program control and keyboard inquiries must also be made, the ITI switch must be plugged to allow

the operator to gain control of the typewriter so that the five-digit address may be keyed in. The inquiry procedure is as follows:

1. The Test Lock must be off.
2. The Control Selector switch should be set to RUN.
3. Depress the desired Format key.
4. When the program reaches the step which tests the Inquiry IN hub, the Inquiry light will turn on and the program will stop. (The Cycle lights will show continuous Delay and Exit cycles.)
5. When the Inquiry light turns on, key in the five digit address*
6. After the fifth key is depressed, the typewriter will automatically tab to the first tab stop, the access arm will seek the first record, the record will be transferred to the Q track, and the typewriter will begin to type the record under control of the Typewriter Control Panel. As soon as typing begins, the Inquiry OUT hub will emit an impulse which may be wired to restart the program. NOTE: If it is desired to maintain manual control over the typewriter after the inquiry has completed its type-out (e.g., to manually align the typewriter carriage paper at a different location), the Program Stop key may be depressed before the inquiry has completed typing. After typing has ceased, the carriage paper may be aligned and operation may be resumed by depressing the Program Start key.

*NOTE: Alphabetic and special characters and numbers larger than 49999 entered through the keyboard have the same effect as when entered through the program.

Inquiries — Drum Information When Not Processing

To investigate the information on one of the drum tracks:

1. The Test Lock may be either on or off.
2. The Control Selector switch is set on RUN.
3. Depress the Read key (read "to Q").
4. Depress the desired character key on the keyboard. Character key A will call out track A; numerical key 2 will call out track 2; hyphen (-) will call out the core unit, etc. It is not possible to investigate information on a drum track while the machine is processing. The machine must be stopped.

ALTERATIONS TO DRUM TRACKS

THE FOLLOWING procedures may be used when altering the drum tracks.

Altering Part of the Information On a Drum Track

To alter part of a drum track:

1. The Test Lock must be on.
2. Depress the Read key.
3. Select the proper track by depressing the corresponding character key. The machine will automatically type out the entire track.
4. Depress the Alter key to place the keyboard in a condition to type on the Q track.
5. Duplicate the track information on the typewriter track by holding down the DUP key. Duplicate up to the position to be changed.
6. Type the new information.
7. Depress the Clear key after all alterations have been completed.
8. Depress the Write key.
9. Depress any desired track key except R (R is inoperative and the file cannot be altered). This will transfer the information that has been typed to the selected drum track. The entire track will be written as typing starts. Thus, it is unnecessary to wait until the entire track is typed out except for visual verification. The Clear key may be depressed at any time to stop typing if the entire record is not desired.

Altering a Complete Drum Track

To alter a complete drum track, proceed as follows:

1. The Test Lock must be on.
2. Clear the Q track. This may be accomplished by depressing the Read key, the space bar, and the Clear key in this order.
3. Depress the Alter key to place the keyboard in a condition to type on the Q track.
4. Type the desired information.
5. Depress the Clear key if typing less than 100 characters.
6. Depress the Write key.
7. Select the desired track by depressing the corresponding character key. This will transfer the record to the selected track. The entire track will be written as typing starts. Thus it is unnecessary to

wait until the entire track is typed out except for visual verification. The Clear key may be depressed at any time to stop typing if the entire record is not desired.

TESTING PROCEDURES

THE FOLLOWING procedures will be useful during the initial testing of RAMAC programs.

Testing Typewriter Control Panel Formats

Either inquiry or document printing formats may be tested one position at a time. The Format 1, 2, and 3 control panel hubs initiate the starting impulse for inquiries, while document printing programs are started by the Type hub impulse which signals that the process unit has requested a typing operation.

To test:

1. Inquiry format
 - a. Depress the Reset key.
 - b. Turn the selector control switch to FORMAT TEST.
 - c. Depress the appropriate Format key (1, 2, or 3).
 - d. Key in the desired file address.
 - e. Depress the Program Start key one time for each cycle of operation on the typewriter control panel program. This will initiate typed characters, spaces, tabulations, carriage returns, etc., depending upon the control panel wiring.
2. Document-printing format
 - a. Reset the process unit.
 - b. The test record must be on the typewriter track.
 - c. Turn the Selector Control switch to FORMAT TEST.
 - d. Depress the Program Start key one time for each cycle of operation on the typewriter control panel program.

Program Testing

The following procedures may be useful when testing a new program. Method 1 will execute a program one step at a time; method 2 will execute several program steps or a complete routine before stopping.

METHOD 1

1. The Test Lock should be off.

2. The File Interlock switch on the process control panel should not be plugged. By leaving this switch unplugged, it is impossible to destroy a file record.
3. Turn the program selector switches so that they correspond to the first program that is to be executed, and place the control selector on CONTROL STOP.
4. Place program load cards in the machine, and proceed through a normal program load routine.
5. After the processing unit has stopped on the first program, turn the Control Selector switch to SINGLE OPERATION.
6. When the Program Start key is depressed, the machine will perform one program step at a time.
7. If the operator wishes to examine a track at any time, it is only necessary to depress the Keyboard Read key, and then type out the desired track by depressing the corresponding character key.

NOTE: Because the File Interlock switch is not jack-plugged during this procedure, each time the program attempts to write onto the disk storage, the machine will stop and the File light will glow. Operation may be resumed by depressing the Check Reset, setting the program selector switches to the next program step, depressing Program Set, and then Program Start. It may be desirable to replace the file write instruction with a transfer to output and print or punch during testing to check results.

METHOD 2

1. The Test Lock should be off.
2. The File Interlock switch on the process control panel should not be plugged. By leaving this switch unplugged, it is impossible to destroy a file record.
3. Turn the program selector switches so that they

correspond to the first program that is to be executed, and place the control selector on CONTROL STOP.

4. After the processing unit has stopped on the initial step of the first routine, place the program selector to the first step of the second routine. When the Program Start key is depressed, the machine will perform the first routine and stop before executing the second routine.
5. At this point, the operator can investigate the tracks that have been affected to determine if everything is in order. This may be accomplished by depressing the Keyboard Read key and selecting the proper track.

NOTE: Because the File Interlock switch is not jack-plugged during this procedure, each time the program attempts to write onto the disk storage, the machine will stop and the File light will glow. Operation may be resumed by depressing the Check Reset, setting the program selector switches to the next program step, depressing Program Set, and then Program Start. It may be desirable to replace the file write instruction with a transfer to output and print or punch during testing to check results.

Track Clearing

It is often desirable to clear a track to blanks or the accumulator track to zero. This can be accomplished by using the console keyboard. The operation is as follows:

1. Turn the Test Lock on.
2. Depress Read and Space. This writes blanks on the Q track. The Q track can now be used to blank out other tracks (e.g., track W) by depressing Write and the appropriate character key (W in this case). To reset the accumulator track, depress Read and M.

380 Console Typewriter

A MODIFIED IBM Electric Typewriter located on the console unit is used as an output device for the RAMAC system. It may be used for output of inquiries or as a supplementary printer under the control of the stored program.

The standard typewriter is equipped with a 16-inch carriage. Vertical spacing is six lines to the inch. Either a solid or pin feed platen may be installed. Associated with the typewriter is a control panel that provides the flexibility necessary for format control.

Typing is started by impulsing the TYPE hub on the Process Control Panel or initiating an inquiry. Typing proceeds one character at a time from left to right across the page, under control of the Typewriter Control Panel, until the operation is halted by impulsing the Clear hub.

TYPEWRITER CONTROL PANEL

THE FOLLOWING hubs are located on the Typewriter Control Panel (Figure 62):

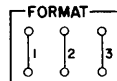

F-G, 13-15

Format. These hubs emit an impulse when the corresponding format (1, 2, or 3) key is depressed on the keyboard. The impulse from these hubs may be used to set selectors to establish format control for three different types of inquiries, and to establish the starting point of the Typewriter Control Panel program. The impulse is not available until after the desired record has been transferred to the typewriter track.



F-G, 16

Type. When the TYPE hubs are impulsed on the process control panel, the hubs labeled TYPE on the typewriter control panel emit an impulse that may be used to establish the starting point of the Typewriter Control Panel program, and to pick up selectors to establish format control for lines typed out under stored program control.

COL. CTRL. EXITS				COL. CTRL. EXITS											
0	o	o	o	4	o	50	o	o	o	54	o				
5	o	o	o	o	o	55	o	o	o	o	o				
10	o	o	o	o	o	60	o	o	o	o	o				
15	o	o	o	o	o	65	o	o	o	o	o				
20	o	o	o	o	o	70	o	o	o	o	o				
25	o	o	o	o	o	75	o	o	o	o	o				
30	o	o	o	o	o	80	o	o	o	o	o				
35	o	o	o	o	o	85	o	o	o	o	o				
40	o	o	o	o	o	90	o	o	o	o	o				
45	o	o	o	o	49	o	o	o	o	95	o	o	o	99	o

A-K, 3-7
A-K, 18-22

Column Control Exits. When the typewriter is being used for inquiries or for printing an auxiliary document, these hubs sequentially emit impulses that coincide with the reading of the corresponding position of the typewriter Q track. These impulses control the format of the information being typed.

The first Q track position to be read is controlled by wiring the COLUMN CONTROL ENTRY. Subsequently,

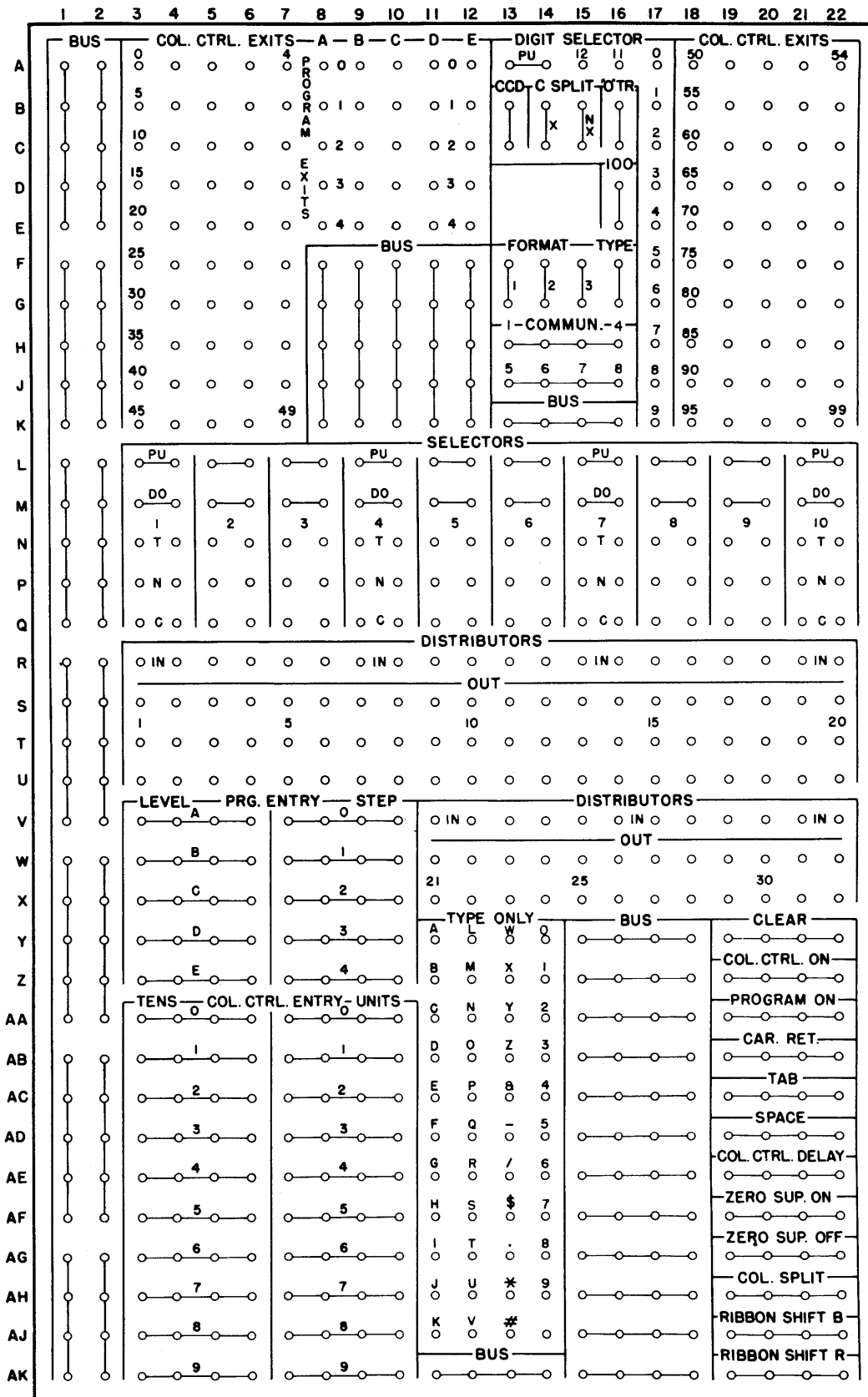

Figure 62. 380 Typewriter Control Panel

the machine reads succeeding positions until the control is transferred elsewhere. This arrangement allows the typewriter to type fields from the typewriter track in any order.

If at any time the program unit or the COLUMN CONTROL DELAY is turned on, the COLUMN CONTROL EXITS stop emitting; but the same sequential position is held, unless the COLUMN CONTROL ENTRY is impulsed to transfer control to another position. When the PROGRAM ON or PROGRAM ENTRY hubs are impulsed, column control is automatically turned off until COLUMN CONTROL ON or COLUMN CONTROL ENTRY is impulsed. When COLUMN CONTROL DELAY is impulsed, an impulse is emitted from the CCD hub on the following cycle; then, column control is turned on again automatically.



H-K, 13-16

Communication. These hubs connect to the correspondingly numbered hubs on the 305 Process Control Panel to allow a signal communication between the processing unit and the typewriter.

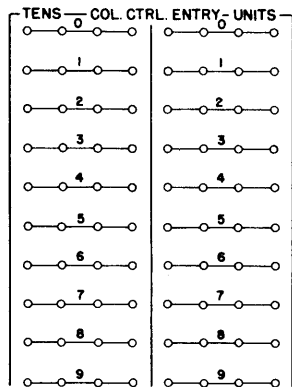

AA-AK, 3-10

Column Control Entry. To establish the beginning of a sequence of column control, one TENS and one UNITS hub are impulsed in the same manner that the PROGRAM ENTRIES are impulsed on the process control panel. Column control is turned on automatically by impulsing COLUMN CONTROL ENTRY, without impulsing COL CTRL ON. COLUMN CONTROL ENTRY must not be impulsed at the same time as COLUMN SPLIT.

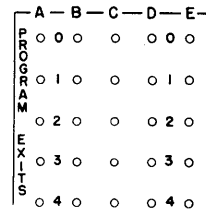

A-E, 8-12

Program Exits. When PROGRAM ON is impulsed, these hubs sequentially emit impulses when the typewriter is being used for inquiries or for printing an auxiliary document. These impulses are used for typewriter control and to type constants, spaces, legends, and special characters not on the typewriter track. Until the program is turned off by impulsing COL CTRL ON or COLUMN CONTROL ENTRY, the program advances through steps 0-4 in levels A-E. When the program is first turned on after the clear of the previous operation, PROGRAM EXIT A0 will emit, followed by A1, A2, A3, A4, B0, B1, B2, . . . E3, E4, A0, A1, etc. The program impulses may be started at another point by impulsing the program entry hubs.

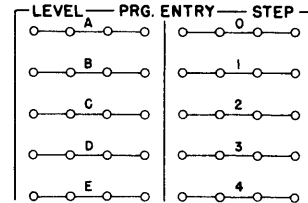

V-Z, 3-10

Program Entry. To establish the beginning of a sequence of program impulses, one LEVEL hub and one STEP hub are impulsed in the same manner that the PROGRAM ENTRY hubs are impulsed on the process control panel. The program unit is turned on automatically by impulsing PROGRAM ENTRY, without impulsing PROGRAM ON.

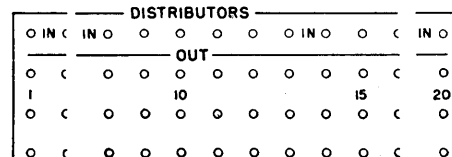

R-U, 3-22

Distributors. Impulses that are used to initiate several functions are wired through distributors that serve the same function as split wires but prevent possible back circuits. An impulse wired into the IN hub of a distributor is available at the associated OUT hubs, but

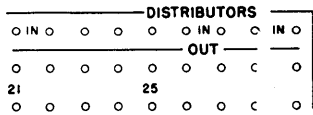

V-X, 11-22

impulses cannot travel between OUT hubs, or from an OUT hub to the IN hub. Any impulse except that from the OUT hub of another distributor may be wired through a distributor.

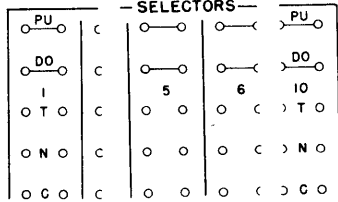

L-O, 3-22

Selectors. Ten 2-position selectors are provided to facilitate format control. Normally, a connection exists between each C hub and the N hub above it. When an impulse is wired to the PU hub, this connection is broken and the C hub is connected to the T hub. This connection remains until DO (drop out) hub is impulsed. All selectors are returned to normal when the CLEAR hub is impulsed. These selectors may be picked up by all impulses, originating on the typewriter control panel.



Y, 19-22

Clear. Impulsing these hubs causes the typing to stop and the carriage to return. All devices that have been picked up, such as selectors and zero suppression, will be dropped out. The column control and program units will be restored to zero and A0, respectively.

When CLEAR is impulsed from a COLUMN CONTROL EXIT while typing, the corresponding column will type; then the typewriter will clear.

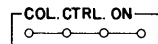

Z, 19-22

Column Control On. These hubs are impulsed to place the typewriter under column control. Program control is automatically turned off. Column control is turned on automatically if a COLUMN CONTROL ENTRY is made.

When impulsed from a typewriter PROGRAM EXIT, column control becomes active one cycle later, and will restart with the next column control position if column control has been previously used. If column control has not been previously used during the Typewriter Control Panel program, column control will start at position zero.

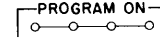

AA, 19-22

Program On. These hubs are impulsed to place the typewriter under program control. Column control is automatically turned off. Program control is turned on automatically when a PROGRAM ENTRY is made.

When impulsed from a COLUMN CONTROL EXIT while typing, the corresponding column will type; then, the machine will be placed under program control. If program control has been previously used, the next program in sequence will emit. If program control has not been previously used during the Typewriter Control Panel program, program control will start with A0.

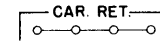

AB, 19-22

Carriage Return. Impulsing these hubs causes the typewriter carriage to return to the left margin.

When impulsed from a COLUMN CONTROL EXIT, the corresponding column will type; then the carriage will return.

Wiring (Figure 63)

The purpose is to type a record that has been transferred to the Q track. The format is a three-line address as indicated.

1. An impulse is made available at the TYPE hub by impulsing TYPE on the process control panel. This impulse is wired to turn column control on. COLUMN CONTROL will start in position zero. Therefore, typing will begin at position zero of the Q track and proceed to position 1, 2, 3, etc. This will continue until the sequence is altered by control panel wiring.
2. The character in position 20 of the Q track will type; the carriage will return; typing will resume.

3. Position 35 of the Q track will type; then, the carriage will return.
4. Position 50 of the Q track will type; then, the typewriter will clear.

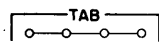

AC, 19-22

Tabulate. Impulsing these hubs causes the carriage to tabulate to the next tab stop. It may be impulsed by a typewriter PROGRAM EXIT or CCD to initiate immediate tabulation, or it may be impulsed from a COLUMN CONTROL EXIT to cause tabulation after the corresponding Q track character has been typed.



AD, 19-22

Space. Impulsing these hubs causes the typewriter to space. It can be impulsed by a typewriter PROGRAM EXIT, CCD, or the COLUMN SPLIT X- or NX- impulses.

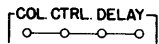

AE, 19-22

Column Control Delay. When these hubs are impulsed, column control is suspended for one cycle, during which an impulse is emitted from the CCD hub. Column control resumes immediately after this cycle, continuing from the step following the step that was wired to impulse the delay.



B-C, 13

CCD. Whenever COLUMN CONTROL DELAY is impulsed, the CCD hubs emit an impulse on the following cycle that may be used for spacing or other functions. Column control is suspended for the cycle on which these hubs emit. After one cycle, the column control resumes from the step after that on which the COLUMN CONTROL DELAY was impulsed.

Wiring (Figure 64)

An inquiry of a disk record is to be made. The disk record is stored as one continuous record. The format is in the same sequence; however, one space is inserted between each field when the record is typed.

1. The units position of each field is wired to the bus.
2. When the Format 1 key is depressed, an impulse will become available as soon as the machine will allow an inquiry. This impulse, wired through a distributor, initiates column control and picks up Selector 9. In this example, it is not necessary to pick up the selector; however, this would be desirable if another format were to be wired on the same control panel. Conflicting instructions could then be selected.
3. The bus is wired through Selector 9 to COLUMN CONTROL DELAY. As the Q track is typed (when positions 4, 30, 35, 41, etc., are reached), COLUMN CONTROL DELAY is impulsed. Column control delay will suspend column control for one cycle, and the CCD hub will emit.
4. CCD is wired to SPACE.
5. Column Control Exit 88 is wired to CLEAR. This will drop out Selector 9 and restore column control to zero.

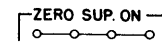

AF, 19-22

Zero Suppression On. When this hub is impulsed, a zero read from the typewriter track will not be typed. Instead, an impulse will be emitted from the OTR hubs, which may be wired to cause spacing or some other function. The printing of zeros is resumed when the ZERO SUP OFF hub is impulsed, or when a character other than zero is read from the track. This arrangement allows the zeros in the high-order positions of fields to be suppressed. Zero Suppress ON is wired from the position (or cycle) before it is to become effective.

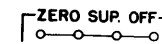

AG, 19-22

Zero Suppression Off. These hubs are impulsed to turn the zero suppression feature off when it is desired to print zeros to the left of significant digits, providing the feature has been turned on by previous wiring. These hubs are wired from the position in which they are to become effective.

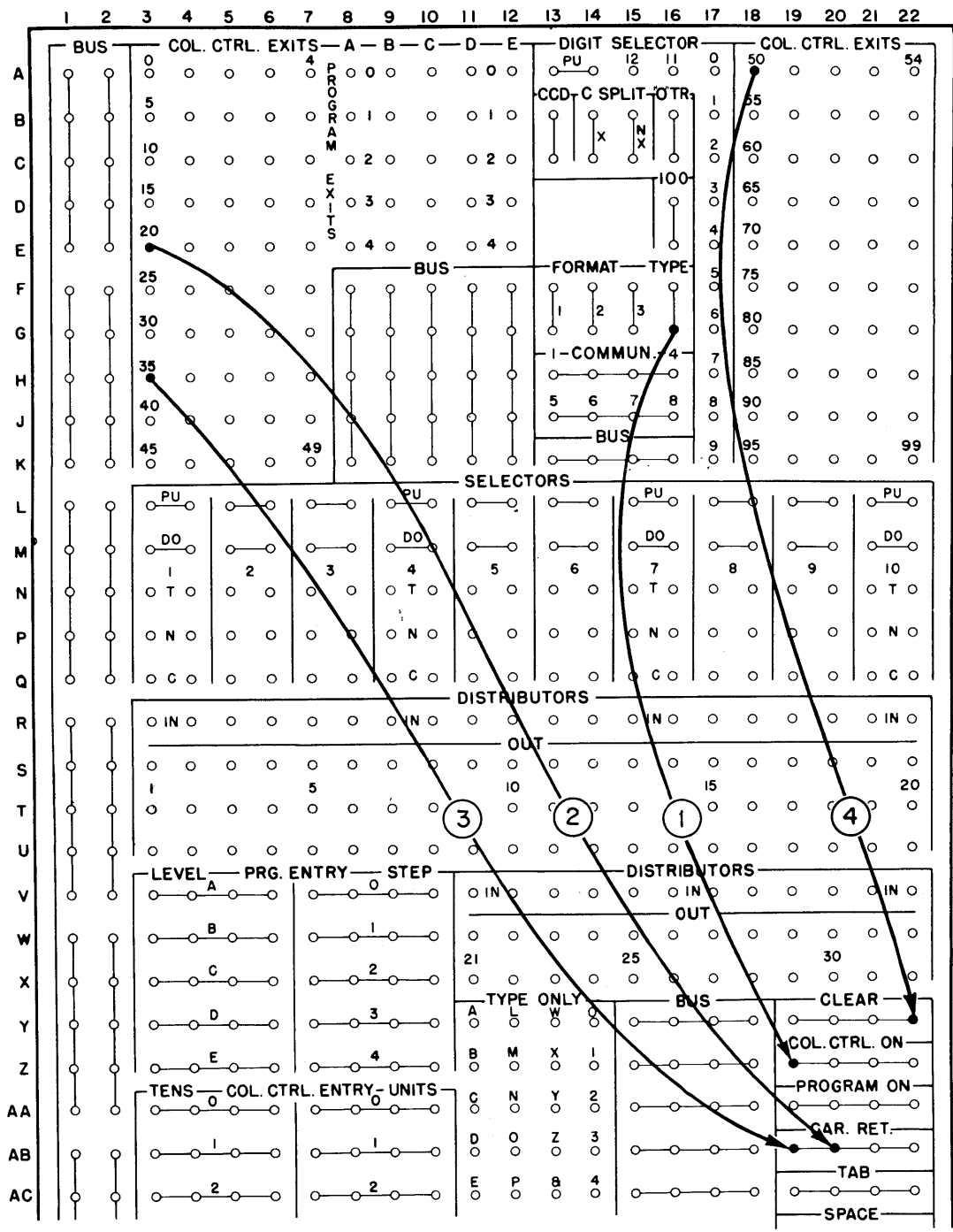

Record

Name	Street Address	City and State
0	20 21	35 36

Name _____

Street Address _____

City and State _____

Figure 63. Printing a Three-Line Address

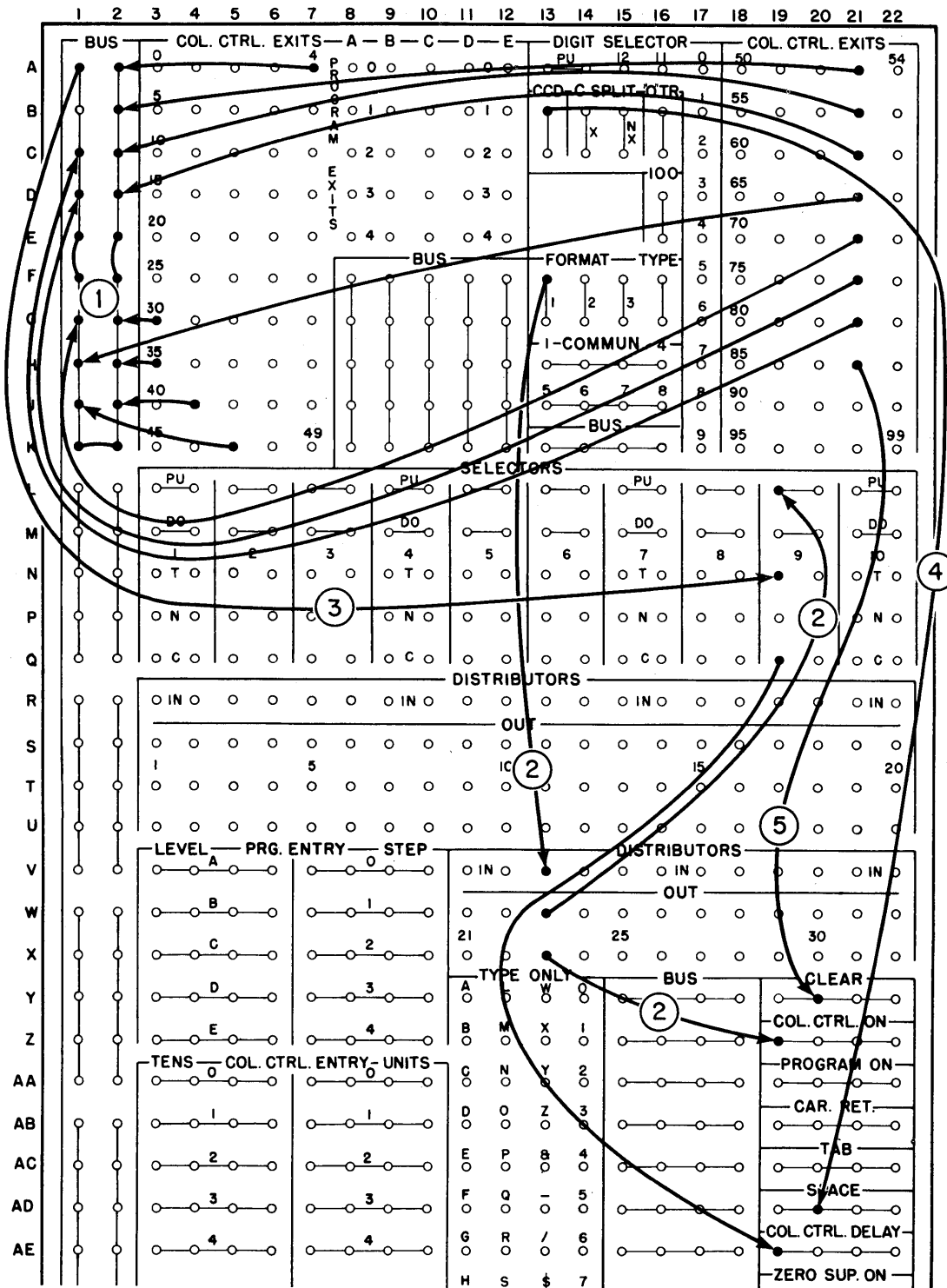

Wiring necessary to print the following disk record inserting one space between each column.

Disk Record

Item No.	Description	Price	Price	Price	Price	Old Bal.	Rec.	Req.	On Hand	On Order	Min. Inv.	Available	
0 4 5		30 31	35	41	47	53	58	63	68	73	78	83	88

Figure 64. Spreading a Record



B-C, 16

OTR. Whenever the zero transfer feature is turned on by impulsing ZERO SUP ON, a zero read from a typewriter track is not printed. Instead, an impulse is emitted from these hubs and may be wired to SPACE to maintain vertical column alignment.



D-E, 16

100 (Type 100). Impulsing this hub causes all 100 characters to be typed from the typewriter track, in position sequence, without format control. All other control panel wiring is inactive during typing when these hubs are impulsed.

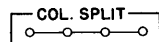

AH, 19-22

Column Split. Impulsing these hubs causes the column split device to analyze the character being typed for the presence or absence of an X-bit. On the next cycle, column control will be suspended, and an impulse will be available out of either the COLUMN SPLIT X- or NX-hubs located adjacent to the digit selector.

When the column split is impulsed from a COLUMN CONTROL EXIT, the corresponding Q track position will type only the numeric portion of the character; that is, the zone portion of any character A through R and some special characters would not print. COLUMN SPLIT must not be impulsed at the same times as COLUMN CONTROL ENTRY.



B-C, 14-15

Column Split (X-NX). When column split is impulsed, any character containing an X-bit (A-R and some special characters) will type as a numerical digit only. In addition, on the next cycle, column control is suspended and the X- or NX-hub will emit. If the character contained an X-bit, an impulse will be available

out of the COLUMN SPLIT X-hub. If the character did not contain an X-bit, an impulse will be available out of the COLUMN SPLIT NX-hub.

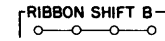

AJ, 19-22

Ribbon Shift Black. Impulsing this hub causes the typewriter to type through the black portion of a two-color ribbon.

When impulsed from a COLUMN CONTROL EXIT, the ribbon will shift for the typing of the next character. Ribbon shift is not affected by CLEAR.

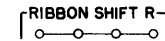

AK, 19-22

Ribbon Shift Red. Impulsing this hub causes the typewriter to type through the red portion of a two-color ribbon.

When impulsed from a COLUMN CONTROL EXIT, the ribbon will shift for the typing of the next character. NOTE: The ribbon should be installed with the black portion up.

TYPE ONLY			
A	L	W	0
B	M	X	1
C	N	Y	2
D	O	Z	3
E	P	B	4
F	Q	-	5
G	R	/	6
H	S	#	7
I	T	.	8
J	U	=	9
K	V	%	0

Y-AJ, 11-14

Type Only Entry. When these hubs are impulsed from PROGRAM EXITS, the corresponding characters are typed. These hubs should not be wired from COLUMN CONTROL EXITS.

Wiring (Figure 65)

Figure 65 illustrates one method of typing a minus sign following an amount field. The units position of the

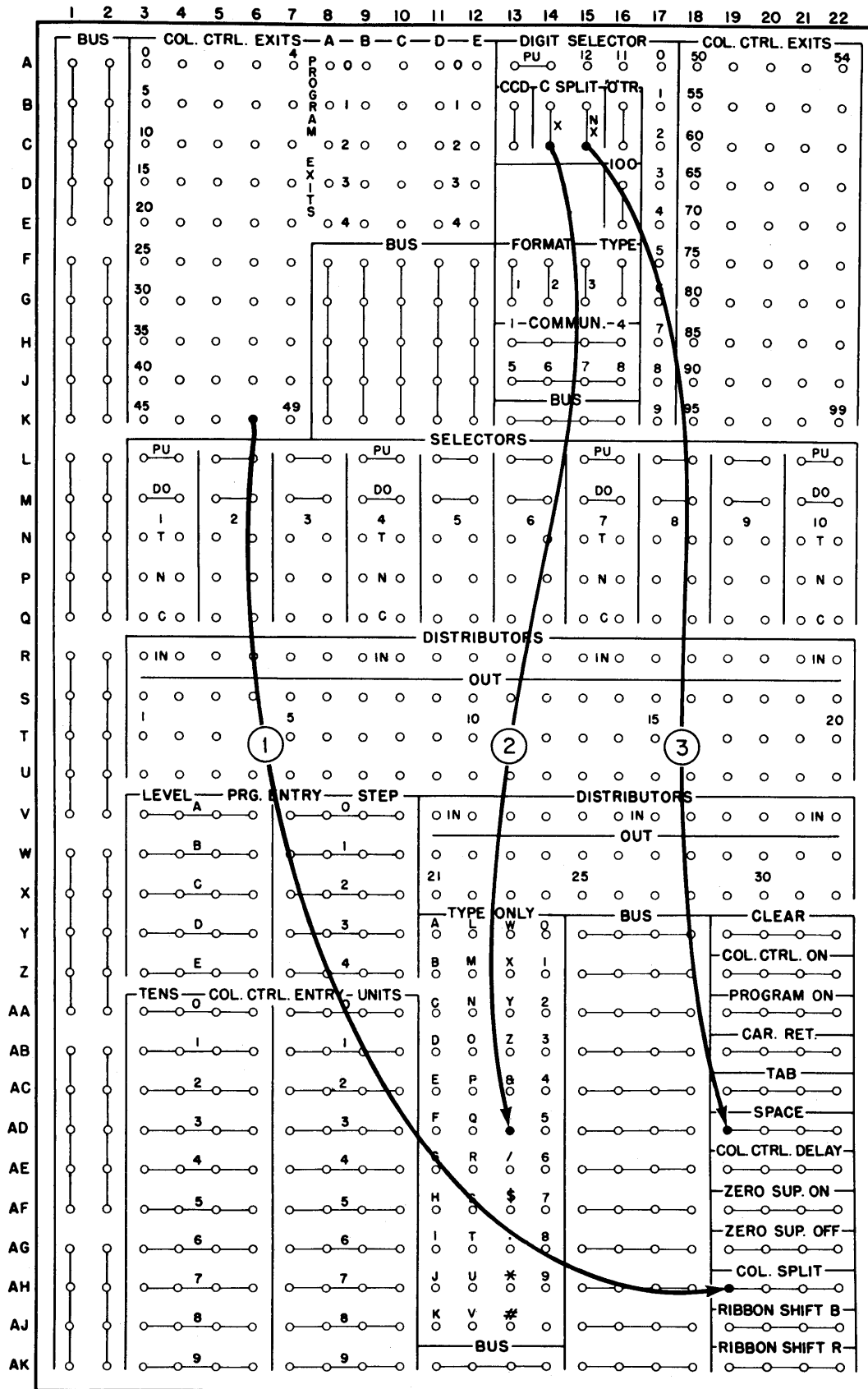

Figure 65. Typing a Minus Sign Following an Amount Field

amount field (position 48) contains a negative X over the digit.

1. Column Control Exit 48 is wired to COLUMN SPLIT.
2. One cycle later the X-hub will emit if the field is negative. This can be wired to type a minus sign (-).
3. If the amount was not negative, the NX-hub will emit one cycle later instead of the X-hub. This is wired to space. The space replaces the minus sign to maintain correct horizontal alignment.

Wiring (Figure 66)

Figure 66 shows one method of typing a record in a rearranged sequence. The record is stored with field 1 in track positions 0-30, field 2 in 31-50, and field 3 in 51-90. The desired sequence of printing is field 2, then field 1, and then field 3.

1. Format 1 is wired through a distributor to COLUMN CONTROL ENTRY so that the typing of the Q-track begins with position 31. This will start typing field 2.
2. COLUMN CONTROL EXIT 50 is wired through a distributor to start typing field 1 after track position 50 has been typed.
3. COLUMN CONTROL EXIT 30 is wired through a distributor to start typing field 3 after track position 30 has been typed.
4. COLUMN CONTROL EXIT 90 is wired to CLEAR.

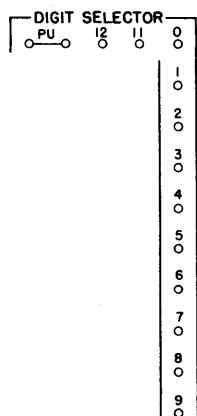

A, 13-17
B-K, 17

Digit Selector. It is sometimes desirable to know the contents of a certain typewriter track position so that format control may be altered on the basis of the character coding. When the PU hub is impulsed from a

COLUMN CONTROL EXIT, the character in that position is analyzed and emitted in IBM code from the hubs labelled 12-9. While this is taking place, the printing of the character is suppressed.

Wiring (Figure 67)

In this example, either PROGRAM ENTRY or COLUMN CONTROL ENTRY will be initiated. The selection is based upon a code located in Q track position 05.

1. Format 1 is wired through a distributor to start column control at position 5.
2. Track position 5 is wired to the digit selector PICKUP.
3. If track position 5 contained a digit 1, program control will be initiated one cycle later beginning at B2.
4. If track position 5 contained a digit 2, column control will be initiated starting with position 21.

Wiring (Figure 68 Part I and II)

Figure 68 shows the program and wiring for typing a disk record. The desired document format calls for one tab setting, and two spaces between the two balance columns. Decimals are inserted by programming.

OPERATING FEATURES

THIS SECTION describes the operating features of the typewriter. In addition, instructions describing typewriter setup are included.

Keys and Levers

1. *Impression Indicator (Figure 69).* This lever can be moved forward and backward permitting changes to be made in the amount of force with which the type bars strike the paper. The higher the indicator is moved, the harder the type bars strike. To determine the correct setting for each type of work, use the comma and period as a test, adjusting the impression indicator so that they print distinctly but not heavily. As a general rule, use a higher setting for multiple carbon copies.

2. *Margin Release Key.* To write beyond the right or left hand margin, depress the Margin Release key and space beyond that point.

3. *Red.* Depress to shift manually to red ribbon.

4. *Black.* Depress to shift manually to black ribbon.

5. *Tab Clear Key.* To clear a tab stop, space to the point to be cleared and depress the Tab Clear key. To

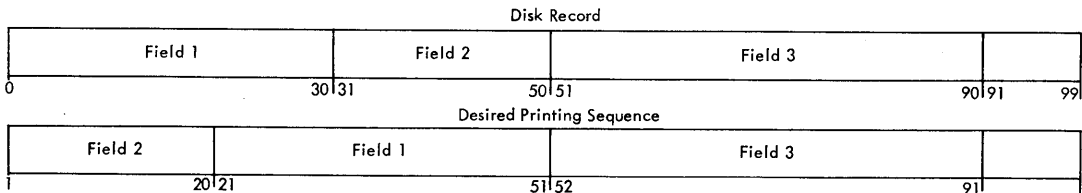
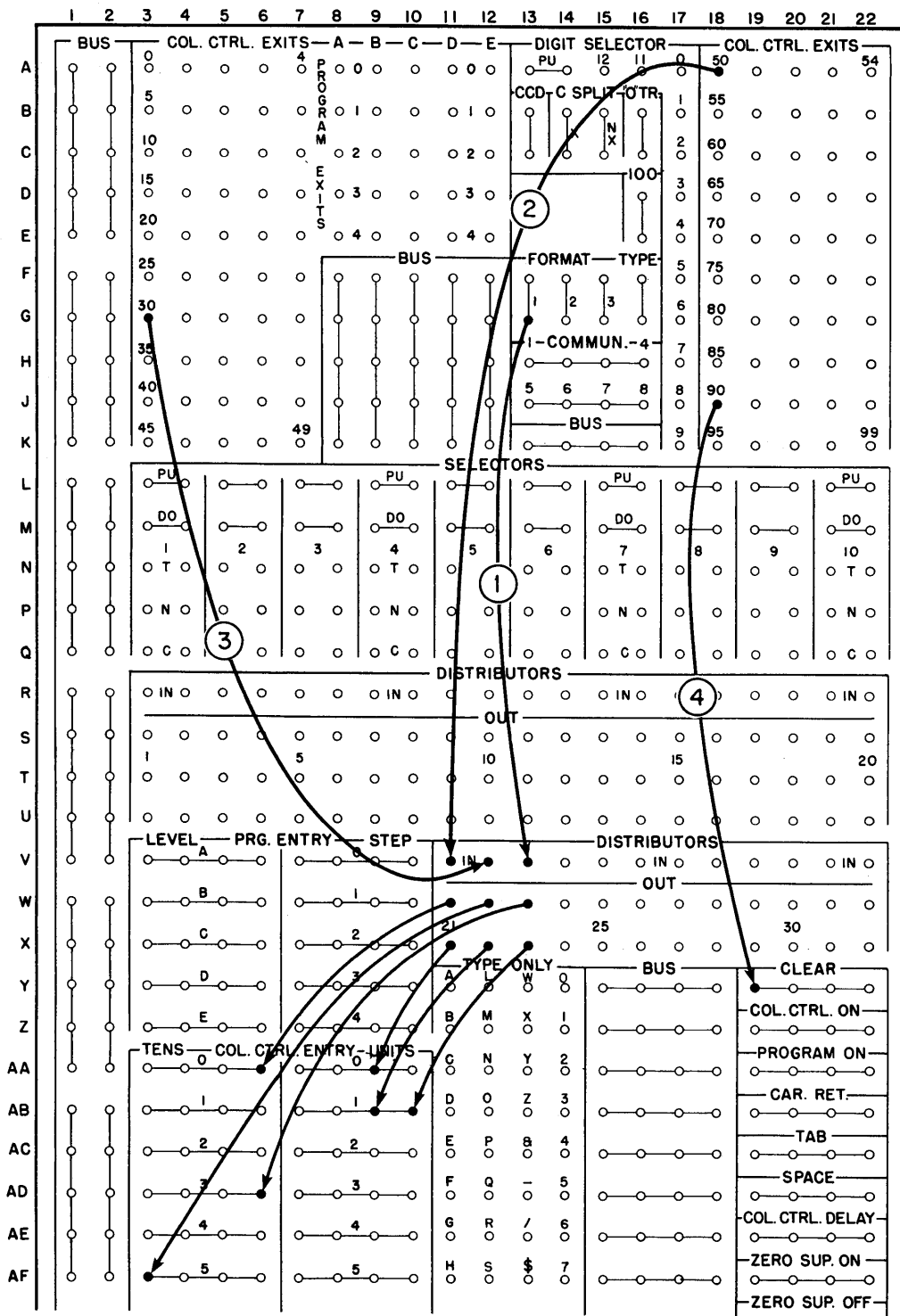

Figure 66. Rearranging Fields

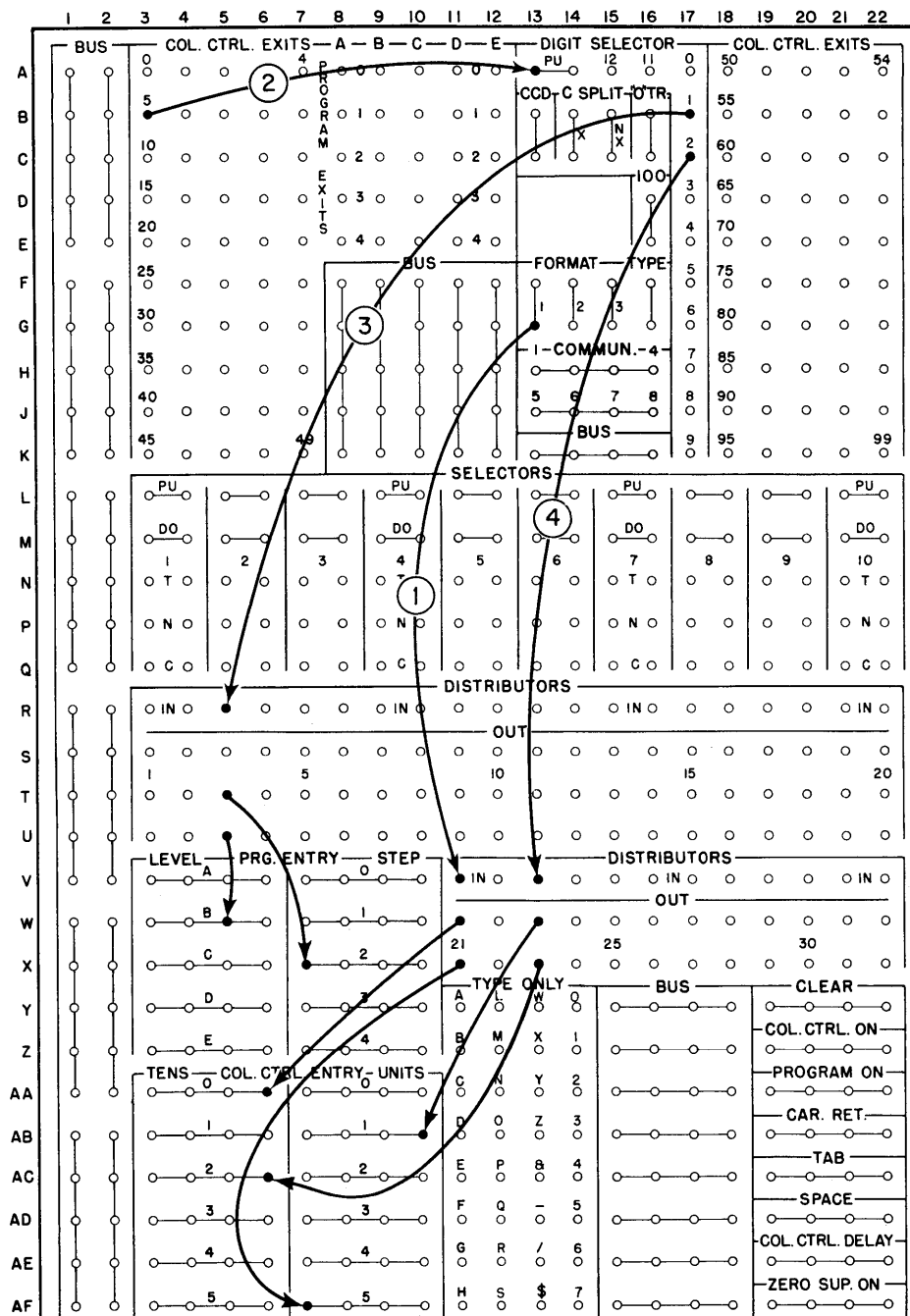

Figure 67. Alteration of Format Control

clear all stops at once, move the carriage to the end of the writing line, depress the Tab Clear key and, while holding it down, depress the Carriage Return key.

6. *Tab Set Key.* To set a tabulator stop, position the carriage and depress the Tab Set key.

7. *Margin Set Key.* The Margin Set key is used to position the left and right margin stops. To reset the left or right margin:

- a. Move the carriage to the present margin stop position.
- b. Depress the Margin Set key and while holding the key down, move the carriage to the new location.
- c. Release the Margin Set key, and the margin stop is repositioned.
8. *On-Off Lever.* This lever turns power on and off to the typewriter.

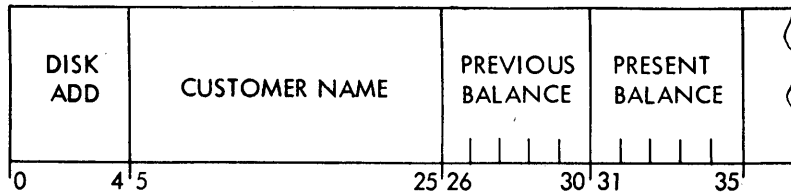

Customer Name		Previous Balance	Present Balance
MASON R D		742.15	795.45

Desired Document Format.
 ▼ indicates tab setting.
 Two spaces are allowed between the two amount fields.

Step	Col. Control Position	Program	Description
1	05		F3 impulse starts program. Start typing name.
2			Type name.
3	25		Type last character of name. Program on.
		A0	Tab, column control on, and Zero sup. on.
	26		Type first digit of previous balance.
4			"0" TR wired to space.
5	28		Column control delay.
6			CCD type decimal, and Zero sup. off
	29		Type tens position of previous balance.
7	30		Type units position, Program on.
8		A1	Space between fields.
9		A2	Space, column control on, and Zero sup. on.
	31		Type first digit of present balance.
			"0" TR wired to space.
10	33		Column control delay.
			CCD type decimal, and Zero sup. off.
	34		Type tens position of present balance.
11	35		Type units position, clear.

Figure 68. Part I

380 CONSOLE CONTROL PANEL (IBM 305 RAMAC)

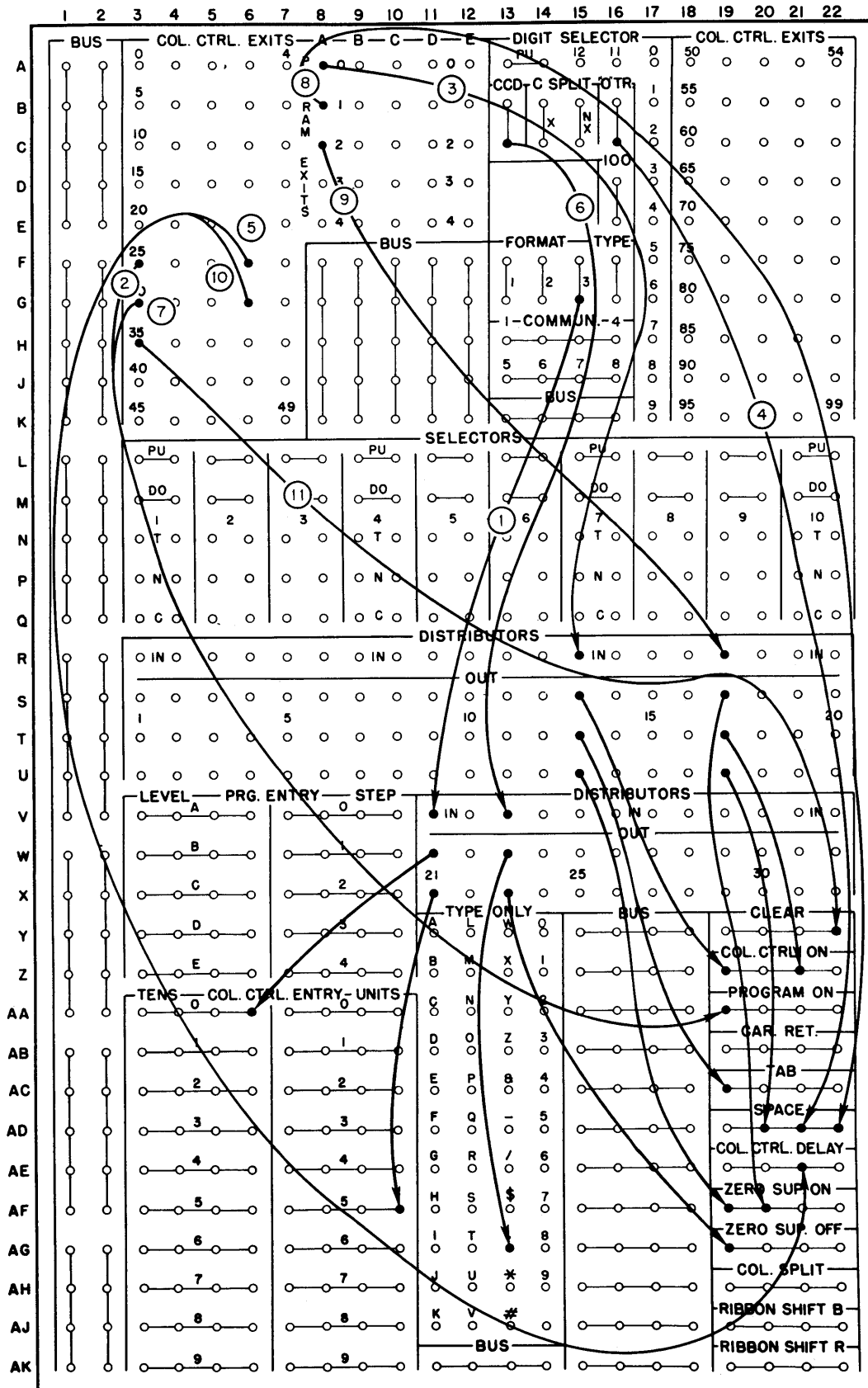

Figure 68. Part II

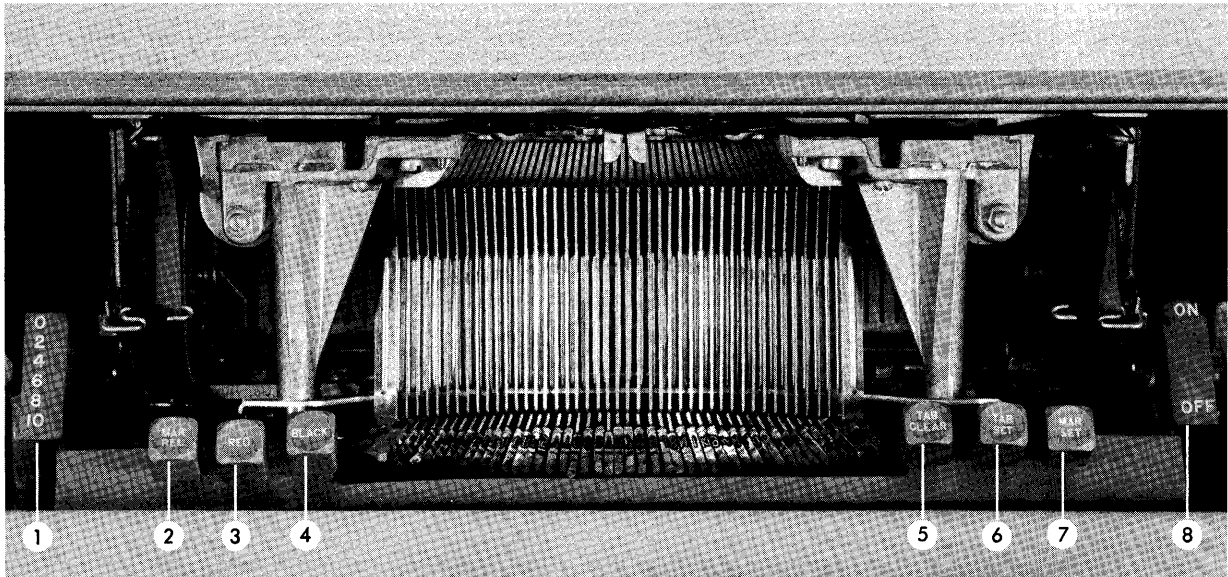

Figure 69. Margin, Tab, and Ribbon Control

Impression and Carriage Control

1. *Line Position Reset* (Figure 70). This lever locks out standard line spacing and provides a free-rolling platen. To return to the regular typing line accurately and automatically, restore the lever to its forward position. The Line Position Reset makes it possible to type above or below the line — double underscore, subscript, superscript, exponent — and then continue with regular

typing. Follow these steps: push back the Reset Lever, roll the platen to the desired place, type. When Reset Lever is returned to the forward position, regular spacing is resumed.

2. *Carriage Release Buttons.* To move the carriage by hand, depress either the left or the right Carriage Release button located on either side of the carriage. (As the left margin is approached, the air-cushioning action that quiets the electric carriage return will be felt.)

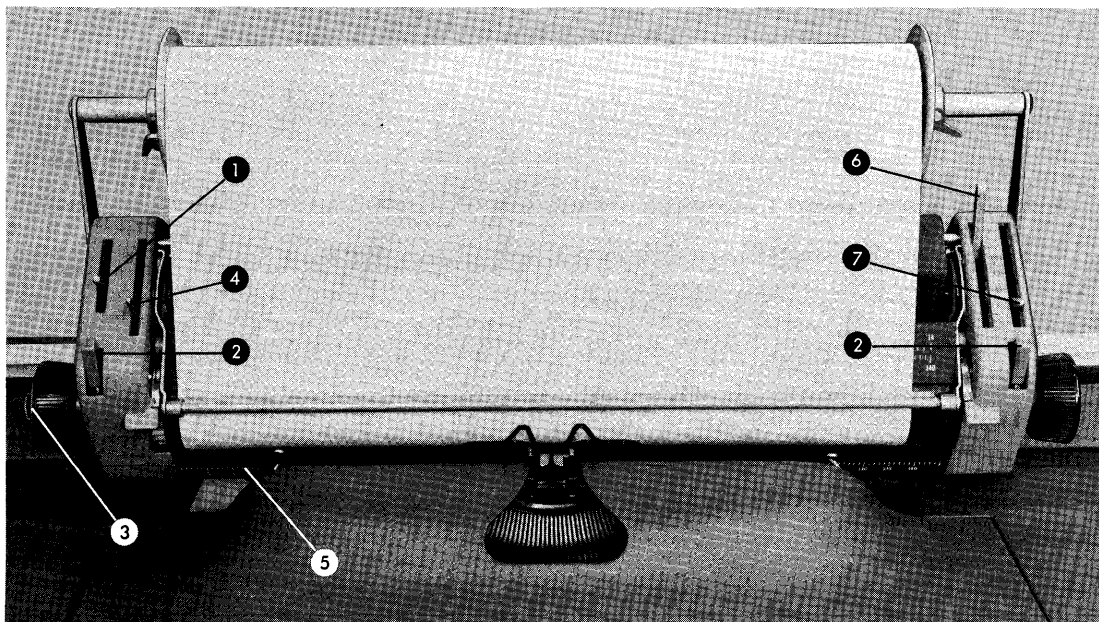

Figure 70. Impression and Carriage Control

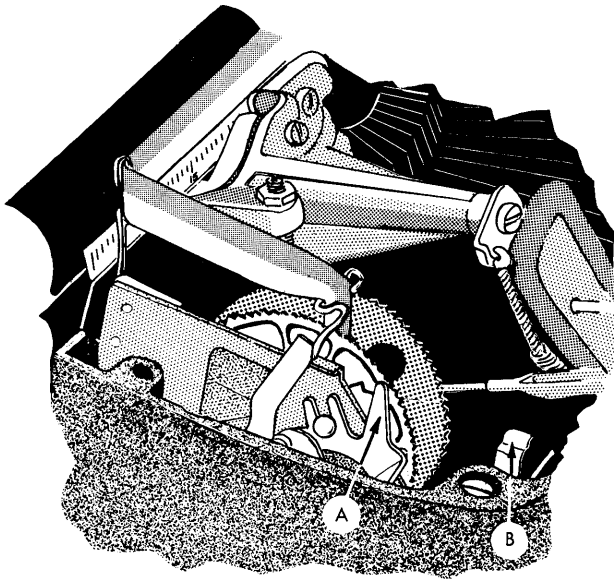

Figure 71. Ribbon Reverse

3. *Platen Variable.* When the Platen Variable is pressed in, the platen moves freely backward or forward. It should be used when re-inserting a typed page and it is necessary to locate the same typing line for corrections or additions.

4. *Line Space Lever.* To select single, double, or triple line spacing, move the Line Space Lever to the positions labeled 1, 2, or 3.

5. *Paper Scale.* This scale indicates the position of the carriage and assists in setting margins and tabs accurately.

6. *Paper Release Lever.* This lever frees the paper for positioning and removal.

7. *Multiple Copy Control Lever.* This lever permits movement of the platen backward or forward to com-

pensate for the thickness of copy paper, allowing the type bar to strike the paper evenly. The weight of paper and carbon paper used are important factors in determining the correct setting. Normally, the Multiple Copy Control lever should be left at "A" when typing one to four copies. As a general rule, the lever should be advanced one position for every three extra copies (after the first four).

To Change Typewriter Ribbon

Open the top cover of the typewriter by grasping the cover at the center opening and pulling up and away from the typewriter. To close, press lightly and the cover will snap shut.

A Ribbon Reverse Lever (A, Figure 71) is located beside each ribbon spool. These levers reverse the ribbon automatically on either side at the end of the ribbon. The direction of the ribbon can be changed by pressing down on the left hand lever to wind the ribbon onto the right spool and vice versa.

Fully depress the Electric Ribbon Rewind (B, Figure 71) and the ribbon will wind automatically onto either spool. (To lock, push down and back.)

To Install a New Ribbon

Depress the Electric Ribbon Rewind and wind all of the old ribbon onto the spool most nearly filled. Hold back the ribbon guide located over the spool; depress the Ribbon Reverse lever next to the spool; pull out the small knob in the center of the spool. Lift out and discard the used ribbon and spool and insert a new ribbon making certain the Ribbon Reverse lever beside this spool is down. Spool teeth on top must point toward the

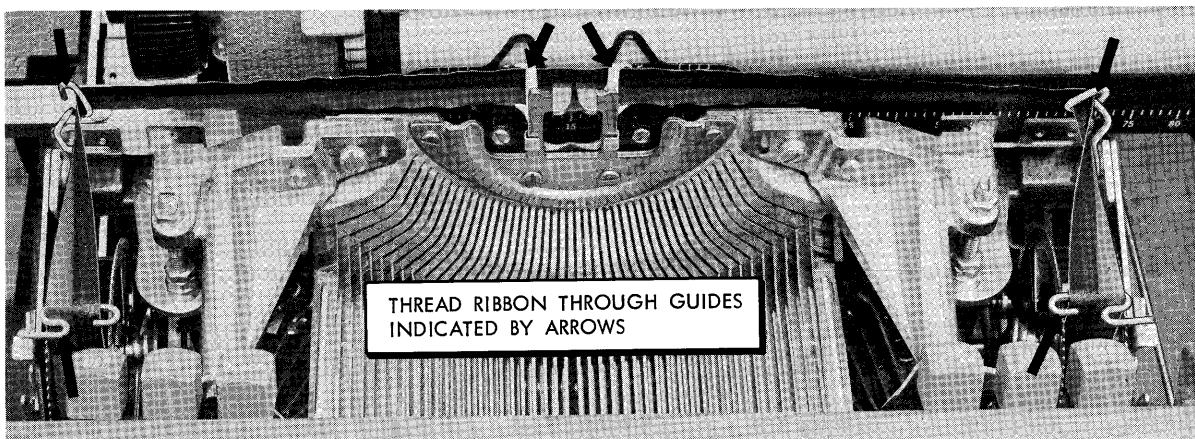

Figure 72. Typewriter Ribbon

platen. Thread the ribbon through the guides indicated (Figure 72). Hook the end of the ribbon on the hub of the empty spool.

Removing the Platen (Figure 73)

1. Center the carriage, raise the paper bail, carriage and covers and copy guide.
2. Push back and lift up latches (see Figure 73). Lift out platen.

To replace platen, center the groove in the right platen shaft on the carriage end plate and bring latches forward and down.

Check these points for proper typewriter operation:

If the motor and typewriter are operating but typebars will not print: . . . make certain that Multiple Copy Control is at "A."

If the carriage will not move:

- . . . turn "OFF" for several seconds, then on.
- . . . with switch on, depress the Margin Release key.

Pin Feed Platen

A pin feed platen with a hole-to-hole width of $1\frac{5}{8}$ inches is available for the 380 Console Typewriter. The pin feed platen maintains proper registration and alignment of continuous forms.

The platen is available in three degrees of hardness — hard, medium, and soft. A hard platen should be used whenever forms with five or more parts are used, but it should never be used with less than a five part form.

Form Feeding

When single-part forms are being fed, the typewriter tear bar should be raised to prevent pressure on the pin-feed guide fingers which could tear the pinfeed holes.

For the best form feeding operation, place the stack of forms directly behind the carriage when it is in the right hand margin. This allows the forms to align directly behind the carriage at the time that it line spaces.

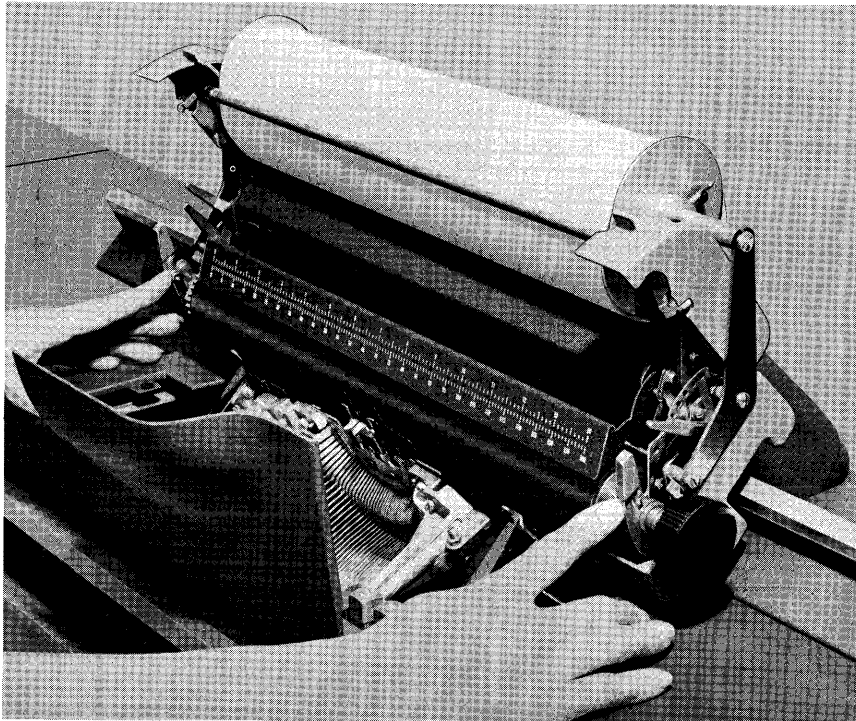

Figure 73. Removing the Platen

370 Printer

THE 370 OUTPUT PRINTER (Figure 74) prepares a printed document while transactions are being processed in the machine. It is a serial printer that prints from a single, octagonal printing stick. Information is printed from the output track. Format control is provided by control panel wiring.

Stick Printing

A single, octagonal printing stick (Figure 75) is used to print the complete alphabet, the numbers 0-9, and eleven special characters. Horizontal spacing is 10 characters per inch, and a total of 80 characters per line may be printed. Vertical spacing is six lines per inch. To print

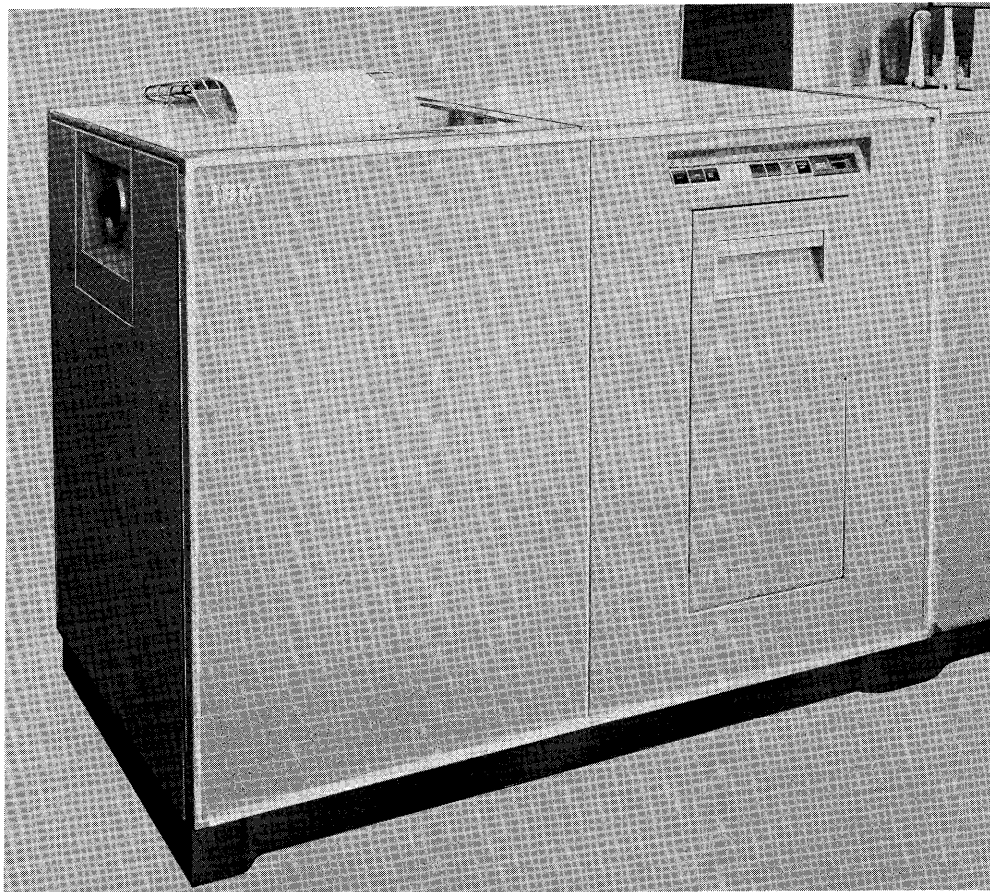

Figure 74. 370 Printer

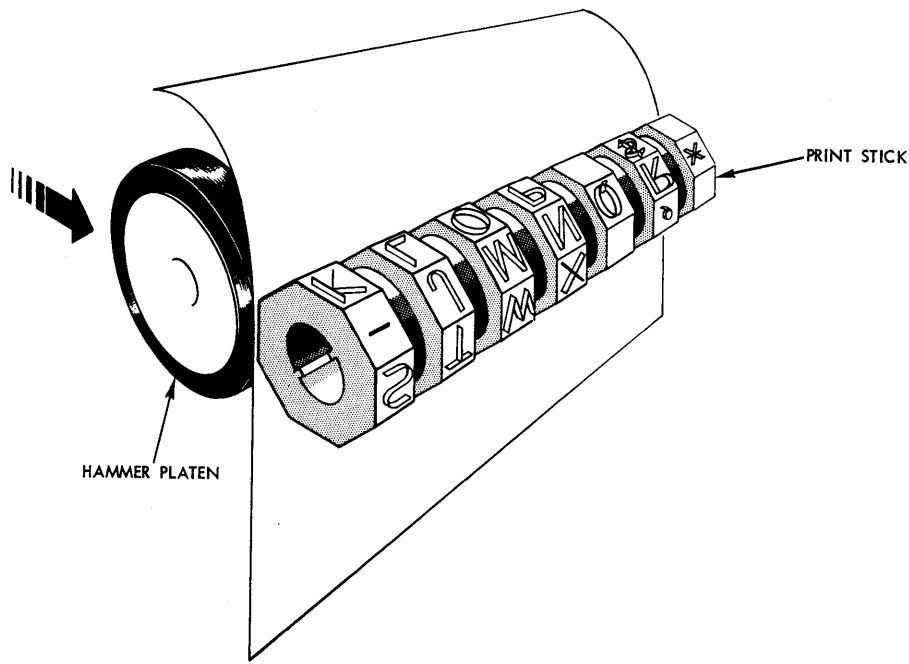

Figure 75. Print Stick and Platen

an 80-character line and return the carriage requires approximately two seconds. Shorter lines are printed in less time.

The print stick is positioned by a combination of horizontal and rotary motion before printing each character. The stick contains seven characters along the length of each octagonal plane. Because the over-all length of the print stick is approximately one inch, and the horizontal spacing between each printed character is one-tenth of an inch, the stick may, in some cases, rotate and move several positions to the left in order to align certain characters for printing. However, because the entire print mechanism spaces one-tenth of an inch to the right before printing each character, the over-all movement of printing is left to right across the page to print 80 characters.

To print each character, a hammer platen, which is located in back of the paper and which is one character in width, strikes the paper from the back, thus forcing the paper against the print stick and ribbon to form the character impression.

Figure 76 illustrates the arrangement of the print stick. When the diagram is folded, the print stick is obtained.

OPERATING KEYS AND LIGHTS (Figure 77)

THE FOLLOWING operating keys and lights are located on the 370 Printer.

Keys

Start. When the Start key is depressed, the printer is placed in a ready condition. The Ready light will come on, and the printer will be put under the control of the processing unit. This key is inactive if the Check light is on. If the Form light is on, it must be depressed for each print line in order to complete printing on the last form.

Stop. Depressing this key during a print cycle will stop the printer after it has completed the cycle, and removes the printer from a ready condition. The process unit will stop as soon as the program attempts a transfer to the output track.

HOME Δ	1	4	5	8	9	@
2	3	6	7		#	
ZERO 0	/	U	V	Y	Z	%
S	T	W	X		,	
-	J	M	N	Q	R	* ✱
K	L	O	P		\$	
&	A	D	E	H	I	⌘
B	C	F	G		.	

Figure 76. Print Stick Arrangement

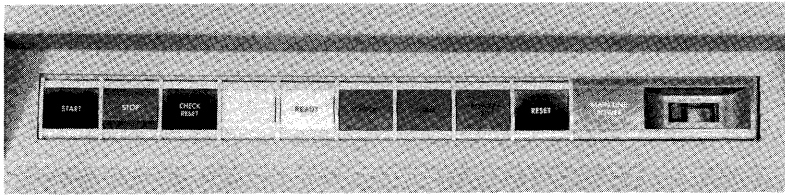

Figure 77. 370 Printer Operating Keys and Lights

Check Reset. Depressing this key restores the printer error detecting circuits, turns off the Check light, and releases the output track interlock. It is used after a printer parity or setup check error.

Reset. When this key is depressed, all printing and error detecting circuits are restored. All selectors are dropped out. Zero suppression, MLP, etc., are reset. Because it will reset all printer circuits, it should not be used after a simple parity or setup check error.

Main Line Power. This switch is used to turn the AC and DC power either on or off.

Lights

Ready Light. When this light is on, the printer is ready to accept information from the processing unit.

Check Light. This light will come on for either a parity or print setup error.

Form Light. This light will come on and the printer will stop when the last form is approximately 1½ inches from the print stick. The operator must insert a new form to turn the light off.

Power On. This light will glow when the printer has been supplied with AC and DC power.

Print Cycle

The basic print cycle may be divided into two sections: analysis and printing. Because it will usually be desirable to vary the document format (headings, body, totals, etc) an analysis or decision period is provided before the actual printing begins.

During the analysis portion of the cycle, any character on the output track may be directed to the control panel and analyzed. Selectors may be transferred, or other devices on the control panel may be set up. In this way, all of the desired controls are established prior to the printing of the first character.

After the analysis period is completed, printing will begin. Printing will continue until line end is impulsed on the printer control panel, or all 80 character positions have been printed.

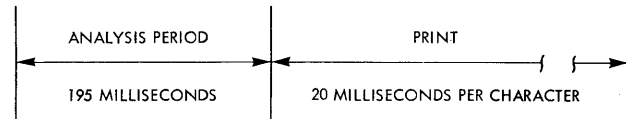

PRINTER CONTROL PANEL

(Figure 78)

THE PRINTER CONTROL PANEL analyzes and directs the flow of information from the output track so that data may be printed in any desired format.

Two types of exit impulses are available at the control panel, high level and low level. A high-level impulse may be wired to the output track, but it should not be wired to pick up a selector or to initiate a control function. The machine cannot be damaged by this type of wiring; however, improper operation would result. High-level impulses are available at the ANALYZER CONTROL IMPULSE hubs and the PRINT POSITION EXITS and should be wired only to Print Space or to the output track. All other exits emit low-level impulses. Both high-level and low-level impulses may be wired through selectors.

To facilitate reference to specific hubs on the control panel, the rows are numbered 1 through 40, horizontally; and they are lettered A through BR, vertically.

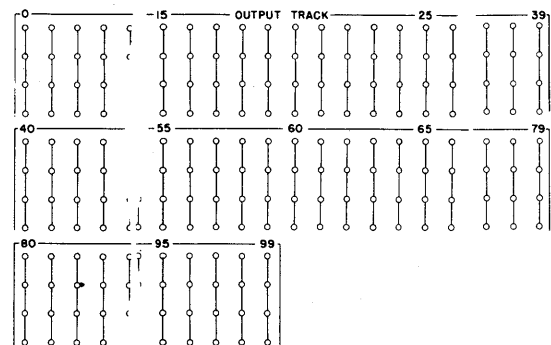

AU- BB, 1-40
BC-BF, 1-20

Output Track. Each of these 100 hubs correspond to a position of the output track. At each printing position the output track is read in its entirety; however, only one character is selected for printing. If an OUTPUT TRACK position is wired from a PRINT POSITION EXIT, printing will result.

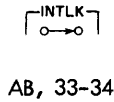

AB, 33-34

Interlock. These hubs must be jackplugged before any printing operation can be initiated. The printer will not operate if these hubs are left unplugged.

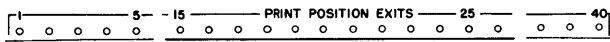

AT, 1-40
BR, 1-40

Print Position Exits. These hubs are wired to the output track to cause the corresponding positions to be set up for printing. An impulse is emitted from each PRINT POSITION EXIT hub as soon as the print head is located for printing at each of the 80 print positions. If PRINT POSITION EXIT 20 is wired to OUTPUT TRACK position 15, as soon as the print head arrives at print position 20, the character located at track position 15 will be printed.

Print position exits emit a high-level impulse that may be directed to the output track through selectors; however, they should not be wired to pick up selectors, to a distributor, or to any function hub such as PRINT START, LINE END, X-ELIMINATE, etc.

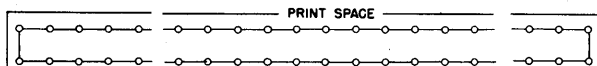

AJ-AK, 1-40
BG-BH, 1-40

Print Space. When a line is printed on a form, a single character is selected for printing at each print position. The machine automatically performs a print setup check on the character that is to be printed. If the print head arrives at a position where the corresponding PRINT POSITION EXIT hub has not been wired, a print setup error will occur. Therefore, all PRINT POSITION EXITS that are not wired to an output track position should be wired to PRINT SPACE. This wiring indicates to the machine that the corresponding print position should be spaced over without printing.

It is not necessary to wire PRINT SPACE if the printer is in a print-off condition. The printer will be in a print off condition if PRINT STOP has been impulsed. PRINT STOP is described later in this section.

Wiring (Figure 79)

Figure 79 illustrates the principle used to transfer data from the output track to print 80 characters. All PRINT POSITION EXITS not wired to an output track position must be wired to PRINT-SPACE if the printer is in a print-on condition. The printer will be in a print-on condition if PRINT START has been previously impulsed. PRINT START is described later in this section.

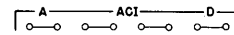

BF, 21-28

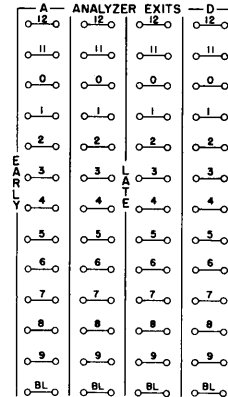

S-AE, 1-8

Analyzers. When a record has been transferred to the output track, and PRINT (on the process control panel) has been impulsed by a program exit, the printer prepares to print a line. However, before the print mechanism moves from the home position, predetermined positions of the output track may be analyzed for the presence of certain character codes which can be used to setup selectors and format control.

An ANALYZER CONTROL IMPULSE hub (ACI) is wired to the output track position that contains the control code. The ACI hub will emit an impulse (high level) which will cause the analysis of the corresponding OUTPUT TRACK position. If the output track contained a digit six, the SIX exit of the associated analyzer will emit; if the output track contained a digit two, the TWO exit will emit, etc. Alphabetic characters

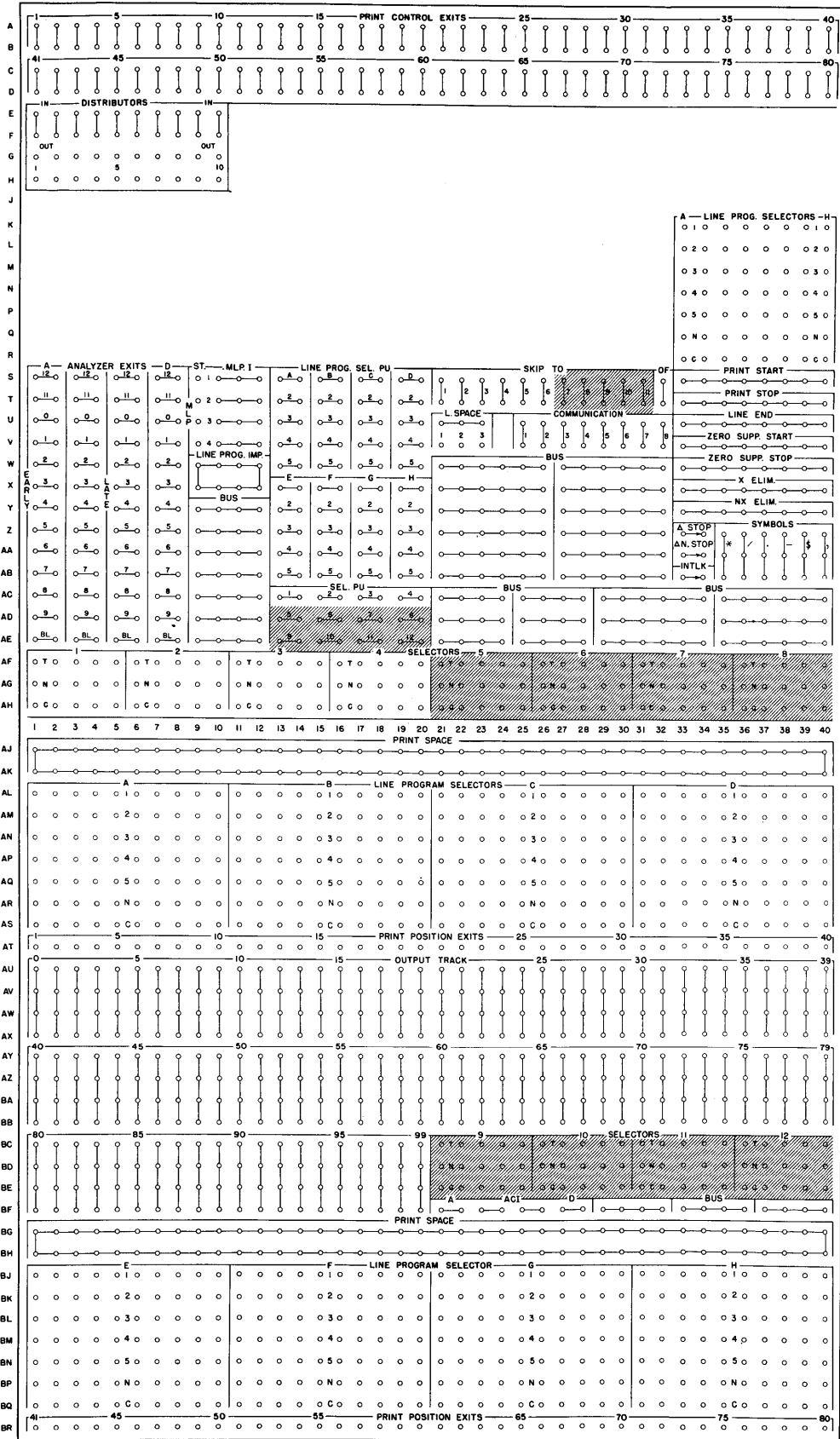

Figure 78. 370 Printer Control Panel

are set up in standard IBM code; that is, if an A is analyzed, the 12 and 1 exits will emit. These impulses are normally wired to pick up selectors or to initiate an MLP (multiple line printing) operation.

The analyzer exit labelled *BL* (blank) will emit

during the analysis portion of every print cycle unless a digit or character appears on the output track in the position being analyzed. If the ACI hubs are not wired to an output track position, the blank hub emits on every print setup cycle except MLP 2, 3, 4.

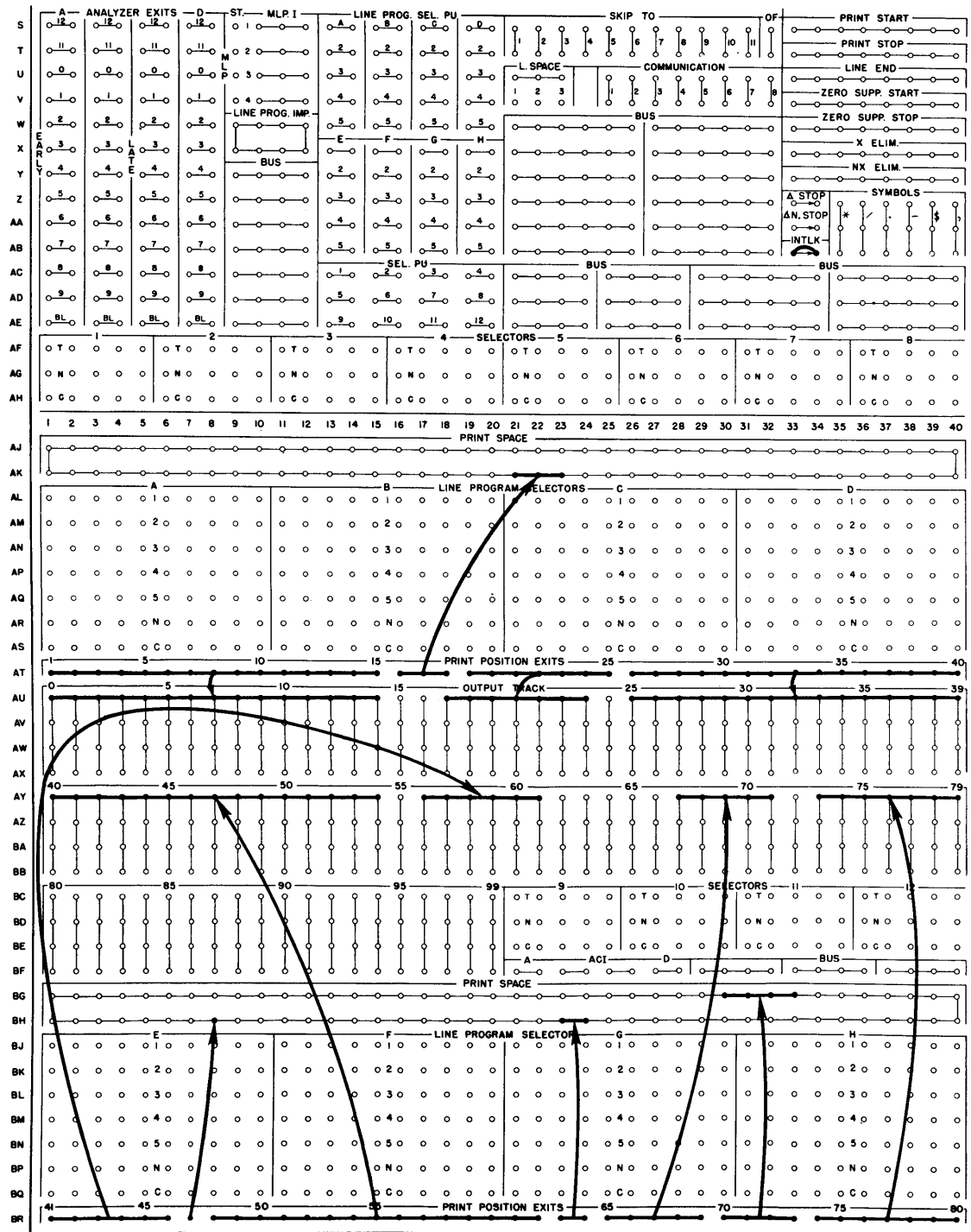
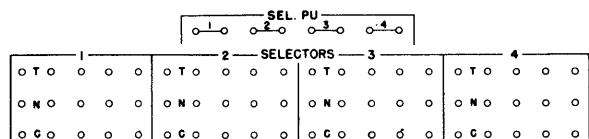

Figure 79. Output Printing and Print Space

The ANALYZER CONTROL IMPULSE (ACI) hubs A, B, C, and D emit sequentially and cause the corresponding analyzers to set up in the same sequence. ANALYZER EXITS A and B are classified as early exits, and emit at the same time—just after setting up analyzer B. ANALYZER EXITS C and D are late exits, and emit at the same time—just after setting up analyzer D.

The early exits must be used to pick up selectors associated with the selection of triple spacing and may also be used to control selectors through which late exit impulses may be wired.



AC, 13-20
AF-AH, 1-20

Selectors. These selectors may be used independently or to supplement the line program selectors. Each selector has five positions, and each position has a COMMON, a NORMAL, and a TRANSFERRED hub. Normally a connection exists between the COMMON and the NORMAL hub; however, when the selector pickup is impulsed, this connection is broken and a connection is made between the COMMON and the TRANSFERRED hub. The selector should be picked up during the analysis portion of the print cycle. It will remain transferred for the entire line and is automatically dropped out when LINE END is impulsed (line end is discussed later).

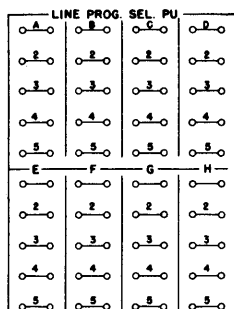

S-AB, 13-20

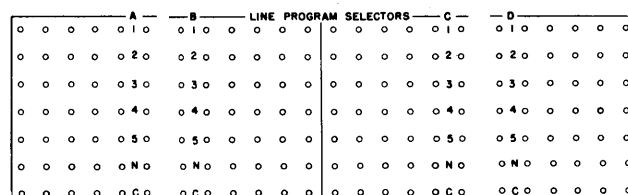

AL-AS, 1-40
BJ-BQ, 1-40
K-R, 33-40

Line Program Selectors. The line program selectors are provided to allow format control of the information being printed from the output track. Each selector has eleven positions; ten of these are grouped near the output track, and an eleventh position of each selector is near the control section. Each position has a COMMON hub, a NORMAL hub, and five TRANSFERRED hubs. The COMMON hub is connected to the NORMAL hub until one of the five pickup hubs is impulsed (during the analysis portion of the print cycle). The COMMON hub is then connected to the corresponding TRANSFERRED hub above it. The line program selectors remain transferred until the line is printed and drop out as the print head returns to the home position.

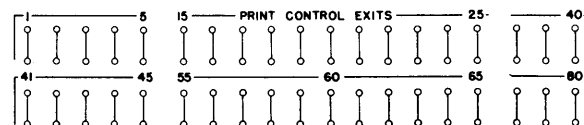

A-D, 1-40

Print Control Exits. These hubs emit control impulses as the printer is positioned to print the corresponding positions of the print line. The emitted impulse may be thought of as an early impulse; therefore, functions can be controlled before the actual printing of each character.

Each hub emits one impulse per line printed; for example, hub number five emits an early impulse each time print position five is being set up. These impulses are wired to initiate functions, such as print start and stop, zero suppression, X-elimination, etc. They may also be wired to print symbols, provided the corresponding print position exit is not connected to the output track or to print space.

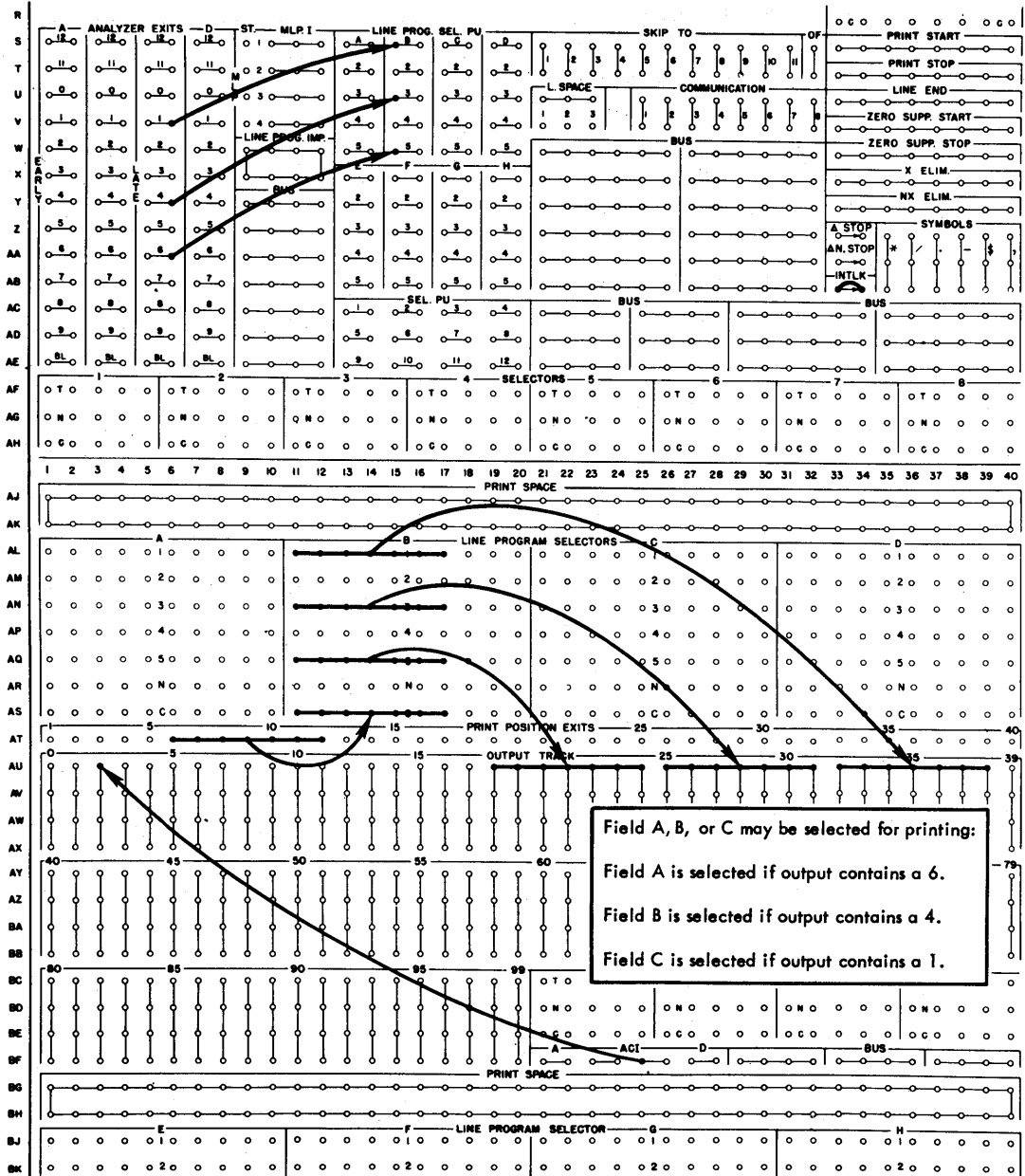
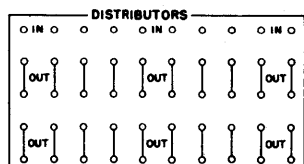

Figure 80. Line Program Selection



E-H, 1-10

Distributors. Impulses that are used to initiate several functions are wired through distributors which serve the same function as split wires but prevent possible back circuits. An impulse wired into the IN hub of a

distributor is available at the associated OUT hub; however, an impulse cannot travel between OUT hubs, or from an OUT hub to an IN hub. Distributors should not be wired so that an impulse from the OUT hub of one distributor is available at the IN hub of another distributor. High-level impulses should not be wired to a distributor.

Print Control Functional Hubs

The following hubs are wired from PRINT CONTROL EXITS to perform such print control functions as starting

and stopping printing, controlling zero suppression, and X-elimination:

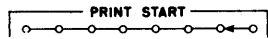

S, 33-40

Print Start. These entry hubs are impulsed from PRINT CONTROL EXITS to start printing at any desired column as the print head moves across the paper. Once printing is started, the machine will continue to print until printing is turned off by impulsing PRINT STOP. In this way, printing can be turned on and off several times in the course of printing a line to give added flexibility in format control. The PRINT CONTROL EXIT for the first column of each field to be printed is wired to these hubs.

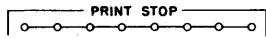

T, 33-40

Print Stop. These entry hubs are impulsed from the PRINT CONTROL EXIT of the first position not to be printed. When information is to be omitted, impulsing these hubs causes printing and print setup checking to be suppressed until PRINT START is impulsed.

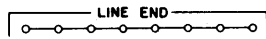

U, 33-40

Line End. These entry hubs are wired from the PRINT CONTROL EXIT of the position after the last position to be printed on a line to cause the printing to stop and the print head to return to the home position. This allows the length of the printing line to be controlled. Variable printing lengths are possible by wiring LINE END through selectors. LINE END need not be wired when printing 80 characters. Line end also causes all selectors and line program selectors to drop out.

If line end is impulsed within the first ten printing positions, it will cause excessive wear on the 370. If less than ten characters are being printed on a line, the print stick should be allowed to space beyond position 10 before line end.

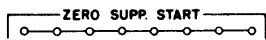

V, 33-40

Zero Suppression Start. These entry hubs are wired from the PRINT CONTROL EXIT of the high-order position of a field to eliminate the printing of zeros to the left of significant digits. When these hubs have been impulsed, the print unit spaces over positions containing zeros until a significant digit (any character other than zero, comma, or diagonal) is encountered. The significant digit is then printed and all zeros to the right of the significant digit are printed.

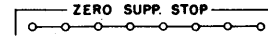

W, 33-40

Zero Suppression Stop. Once ZERO SUPPRESSION START has been impulsed, zero suppression will continue until a significant digit (any character other than zero, comma, or diagonal) is encountered and printed or until it is ended by impulsing these entry hubs from the PRINT CONTROL EXIT of the first position not to be suppressed.

Figure 81 illustrates print controls.

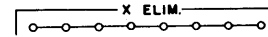

X, 33-40

X-Eliminate. Negative numbers are recorded on the output track (as on all other processing tracks) by an X-bit over the low-order position. For example, the amount 125 stands on the output track as 12N. The X-ELIMINATE and NX-ELIMINATE hubs allow the printer to read the X-bit or the digit portion from an output track position to separate the signed character into its sign and digit components. The X-ELIMINATE hubs are impulsed from PRINT CONTROL EXITS to cause only the digit portion of the character being set up to be printed.

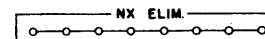

Y, 33-40

NX-Eliminate. A negative number on the output track contains an X-bit over its low-order position. For example, the amount 125 stands on the output track as 12N. By impulsing these hubs from a PRINT CONTROL EXIT, only the sign portion of the low-order digit will print.

Figure 82 illustrates printing a minus sign after an amount field.

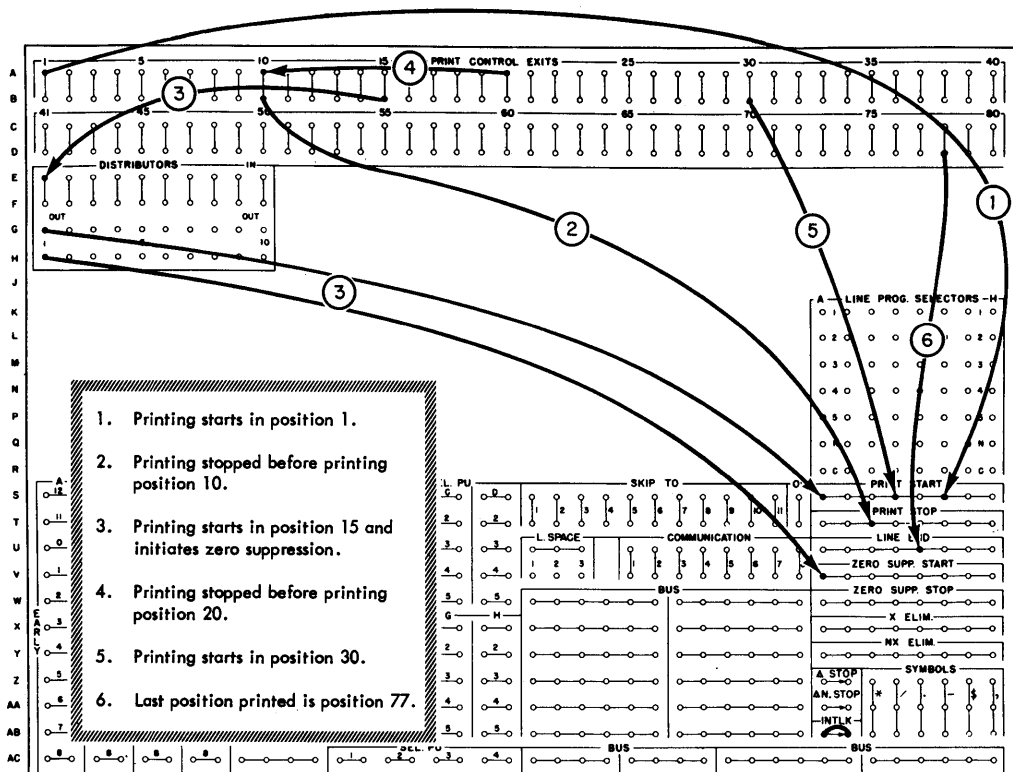

Figure 81. Print Controls

Other Control Panel Hubs

Δ (*Delta*). When the two hubs labelled Δ Stop are jack-plugged (if a print setup error occurs), the machine will print a Δ in the left-hand margin opposite the line in error, and the machine will stop.



Z, 33-34
AA, 33-34

When the two hubs labeled Δ N. Stop are jack-plugged, the machine will print a Δ , but will not stop when a print setup error occurs.

If neither Δ STOP or Δ N STOP are plugged, the machine will stop, but a Δ will not be printed if a print setup error occurs.

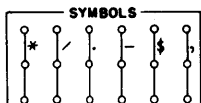

Z-AB, 35-40

Symbols. These entry hubs are wired from PRINT CONTROL EXITS to cause the corresponding symbol to be printed. These symbols may be selected through the line program selector. NOTE: The comma and diagonal is inoperative if zero suppression is on.



U-V, 25-32

Communication. These hubs connect to the correspondingly numbered hubs on the 305 Process Control Panel to allow a signal communication between the processing unit and the printer.

TAPE-CONTROLLED CARRIAGE

THE TAPE-CONTROLLED CARRIAGE (Figure 83) controls feeding, spacing, and skipping while documents are being printed. The carriage is controlled by punched holes in a paper tape that exactly corresponds to the length of one or more forms. Wiring on the printer control panel allows the selection of single, double, or triple spacing between printing lines, as well as skipping be-

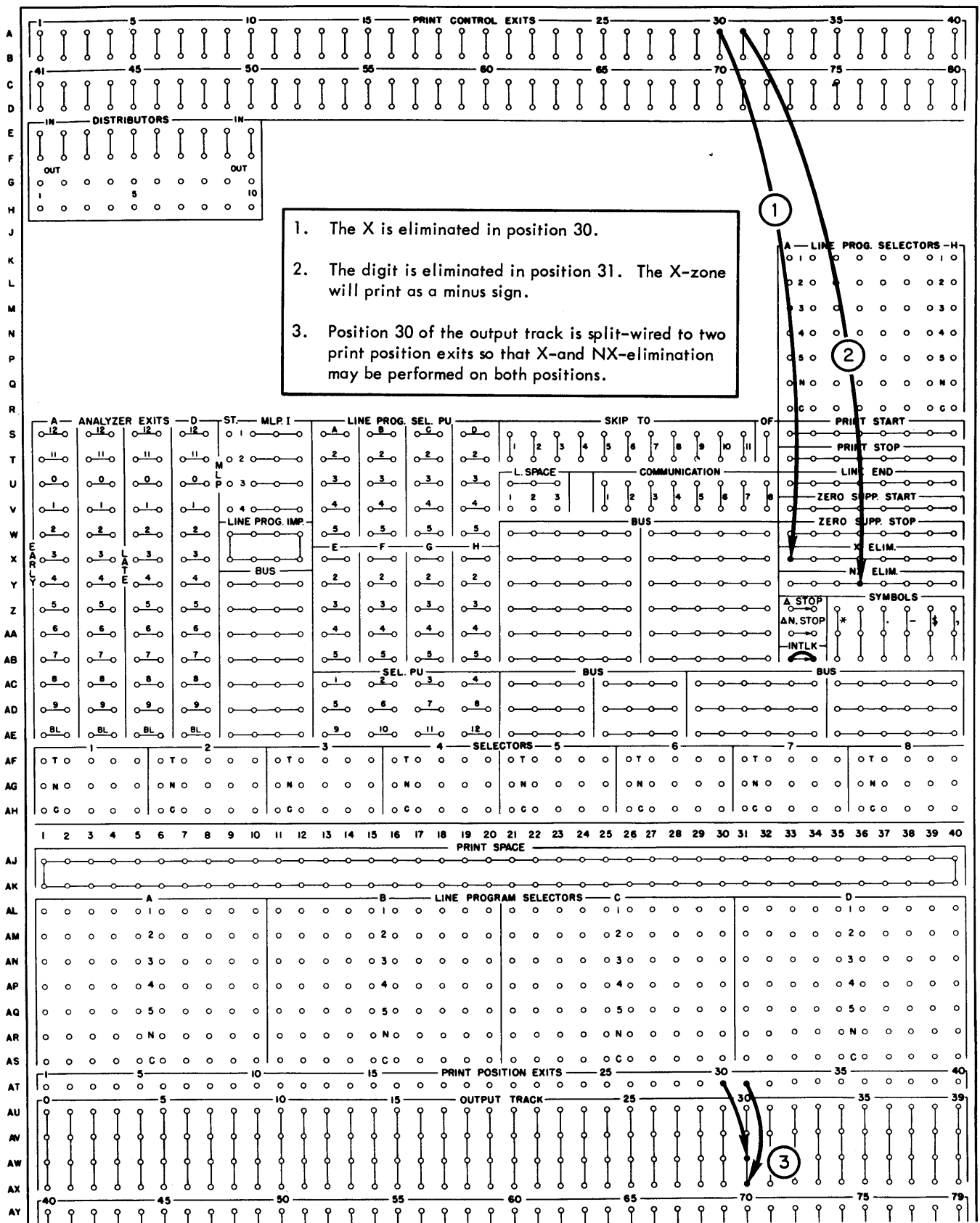

Figure 82. Minus Sign Following an Amount Field

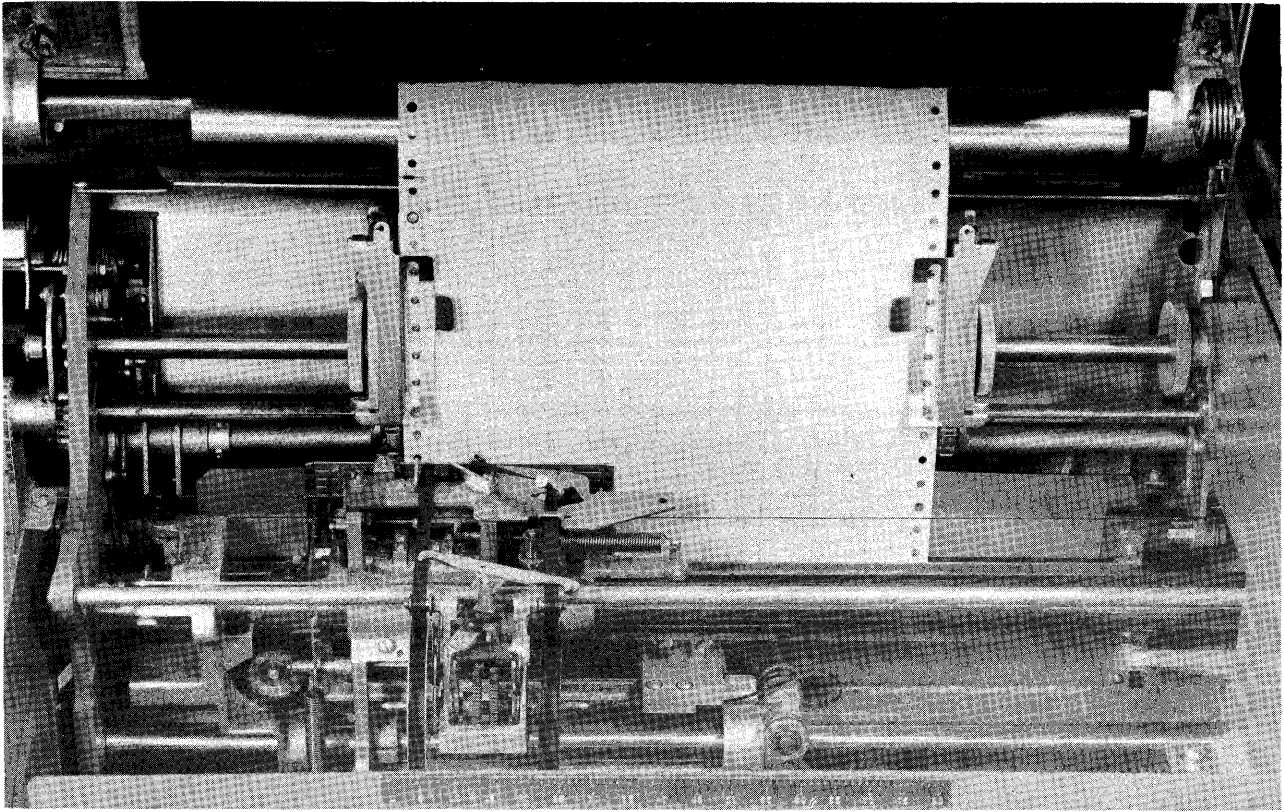

Figure 83. *Tape-Controlled Carriage*

tween forms or within the same form. Line spacing and skipping occur at the rate of 25 lines per second, or 4.17 inches per second.

Control Tape

The control tape (Figure 84) has 12 columnar positions indicated by vertical lines. These positions are called channels. A maximum of 17 inches can be used for control of a form on the 370 Printer, although, for convenience, the tape blanks are longer. Horizontal lines are spaced six to the inch for the entire length of the tape.

Round holes in the center of the tape are pre-punched for a pin-feed drive in a tape-sensing mechanism that controls the carriage. The tape is held in position at one end by the pin-feed device, and at the other end by the weight of a metal spool placed upon the tape.

Seven star wheels, one for each channel, are positioned over the tape for sensing the holes that are punched in the various channels. As viewed from the front of the machine, the number 12 channel is at the far left. Wheel one rests on channel one, wheel two on channel two, etc. A hole in the channel allows the star wheel to drop and cause the setup of the necessary circuits that are used to stop skipping.

Tape Inserting

To insert the tape, open the door located around the platen knob. Release the star wheel assembly by moving the release lever forward (located directly above the star wheel holder). Insert the tape and lower the assembly. Place the metal spool in the lower end of the tape loop. The tape may now be restored to place it at channel one (the home position) by depressing the Restore key.

Tape Punching

A small, compact punch (Figure 85) is provided for punching the tape. The tape is first marked in the channels in which the holes are to be punched. This can be done easily by laying the tape beside the left edge of the form which it is to control with the top line (immediately under the glue portion) even with the top edge of the form. A mark is then made in the first channel on the line which corresponds to the first printing line of the form. Additional marks are made in the appropriate channels for each of the other skip stops and the overflow signal required for the form.

The marking for one form should be repeated as many times as the useable length of the tape will allow. With the tape thus serving to control several forms in

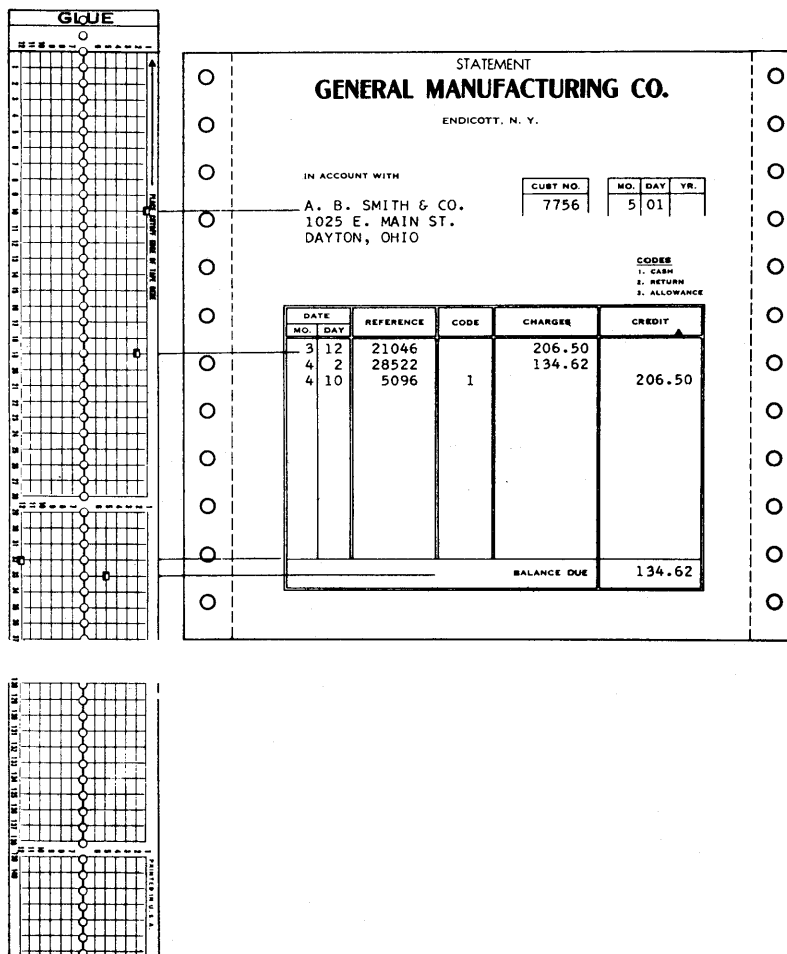

Figure 84. Control Tape

one revolution through the sensing mechanism, the life of the tape is increased. Finally, the line corresponding to the bottom edge of the last form should be marked for cutting after the tape is punched.

The tape is inserted in the punch by placing the line to be punched over a guide line on the base of the punch and placing the center feed holes of the tape over the pins projecting from the base. The dial is then turned until the arrow points at the number of the channel to be punched. Pressing on the top of the punch, toward the back, cuts a rectangular hole at the intersection of a vertical and horizontal line in the required channel of the tape.

After the tape is punched, it is cut and looped into a belt. The bottom line is glued to the top line by the section marked *Glue*, after the glaze has been removed by an ink eraser. If the glaze is not removed, the tape ends may come apart. The center feed holes should coincide when the two ends of the tape are glued together.

The last hole punched in the tape should not be less than four lines from the cut edge, because the last half inch (approximately) of the tape overlaps the glue section when the two ends are spliced. If it is necessary to punch a hole lower than four lines from the bottom of

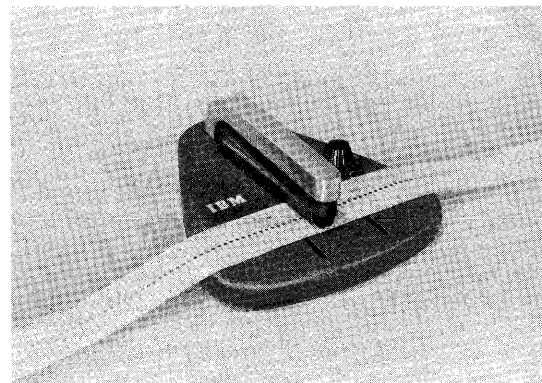

Figure 85. Tape Punch

the form, the tape should be placed with the top line (immediately under the glue portion) four lines lower than the top edge of the form before marking the channels. To compensate for the loss, the tape should then be cut four lines lower than the bottom edge of the form.

Form Sizes and Design

A double forms tractor is adjustable horizontally to accommodate forms with a hole to hole width of up to 16 1/4 inches. The maximum length of a form that may be used is 17 inches.

The length of the printing line has a limit of eight inches. When a form 16 inches wide is used, the eight-

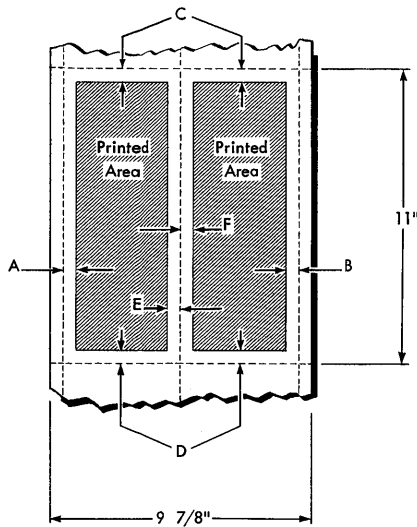

NOTE: Dotted Lines are Perforations

TABLE 1
Single Part Form

Margin	Margin Size	Equivalent Machine Spaces
A	0.200 inch	2 spaces
B	0.300 inch	3 spaces
C	0.500 inch	3 line spaces
D	0.500 inch	3 line spaces
E	0.200 inch	2 spaces
F	0.500 inch	5 spaces

TABLE 2
Multiple Part Form

Margin	Margin Size	Equivalent Machine Spaces
A	0.00	0
B	0.00	0
C	0.500	3 line spaces
D	0.500	3 line spaces
E	0.00	0
F	0.00	0

Figure 86. Printing Specifications (Form Perforations)

inch printing area is centered in the form area, providing a maximum margin of 4.10 inches on the left, and 4.15 inches on the right. Forms of smaller width may be shifted (limited by the width of the form) to effect a shift of the eight-inch printing area on the form. For example, a twelve-inch form may be positioned so that the eight-inch printing area will start at the left-hand side leaving a four-inch margin on the right, or the form could be positioned to leave a four-inch margin on the left. Larger margins can, however, be obtained if the printing starts to the right of position one, or stops before position 80.

Forms with marginal punched holes on both sides must be used. The following tables (Figure 86) indicate the margins that should be maintained in order to prevent paper damage due to the accidental bursting of perforations. These tables include a considerable margin of safety, to compensate for variations in the quality of perforation in accounting machine forms. The possibility of paper jams due to accidental bursting must be guarded against to avoid losing valuable printed information.

The proper design of forms for the 370 Printer will have a marked effect on processing speed and ease of con-

Quantity	Unit	Item No.	Description	Unit Price	Amount
XX	XX	XXXX	XXXXXXXXXXXXXXXXXX	XXXX	XXXXXX
XX	XX	XXXX	XXXXXXXXXX	XXXX	XXXXXX
X	XX	XXXX	XXXXXXXXXXXXXX	XX	XX
X	XX	XXXX	XXXXXXXXXXXXXXXXXX	XX	XXX
XX	XX	XXXX	XXXXXX	XXX	XXXXXX

Figure 87. Field Alignment

trol. Some general rules to remember in designing a form for the 370 Printer are:

1. The time required to print a line depends on the number of characters in the line. Since the print stick spaces one position at a time when passing over blank fields, these blanks must also be considered as characters when determining print time. Keeping blank fields to a minimum and reducing form width can often double the effective printing capacity in lines per minute.

2. Alignment of fields vertically on the form will simplify control panel wiring (Figure 87). Because of

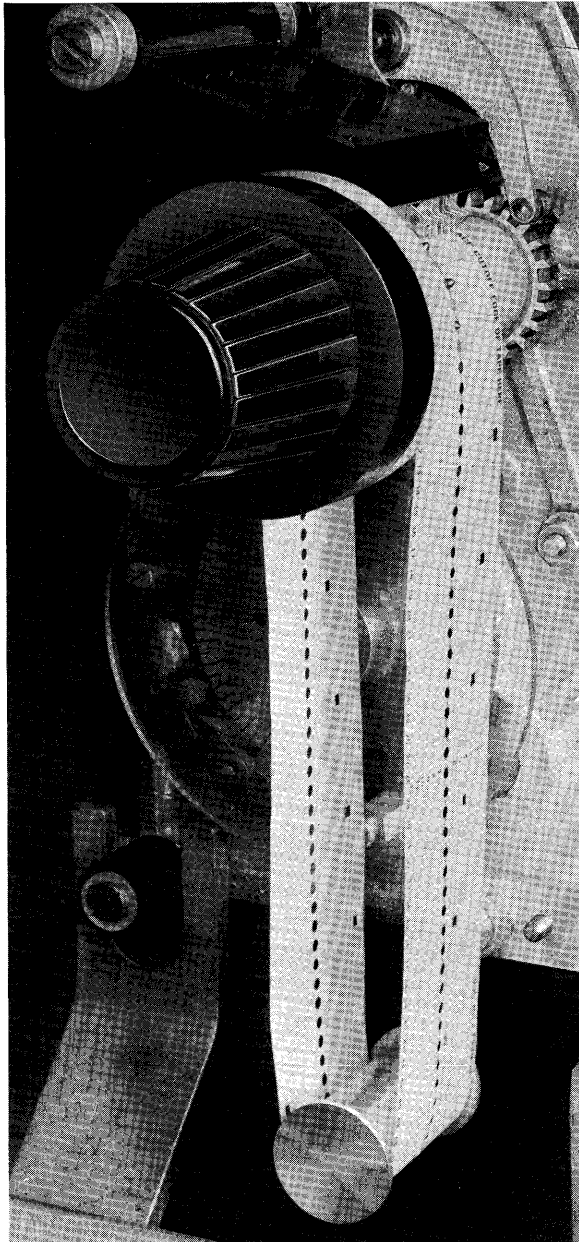

Figure 88. Forms Tractor Positioning Knob

the serial nature of the 370 Printer, control of the print stick as it moves across the form can be simplified by combining print starts, print stops, etc., for several types of lines. By combining functions in this manner, control panel capacity (selectors) can be used most economically.

3. Line program selectors provide for the selecting of six possible format combinations. Form design should always be planned in light of this capacity, and the alignment of similar sized fields should always be considered wherever possible to conserve selector capacity.

4. In many instances, control panel format can be supplemented by properly aligning data for the output track. By overlapping the program time for assembling the output data, it may be possible to achieve this programmed assembly without increasing the operating time required to complete a document.

OPERATING FEATURES

THIS SECTION describes the operating features of the IBM 370 Printer.

Forms Tractor Clutch (Figure 88)

The forms tractor may be disengaged to align the form with the control tape by pushing in the forms tractor positioning knob. To move the form up one space at a time, turn the forms tractor positioning knob with the clutch engaged. To move the form less than one space, disengage the forms tractor clutch and rotate the forms tractor positioning knob.

Restore (Figure 89)

Depressing this key will cause the form to feed if the forms tractor clutch is engaged. To set the carriage at the home position (channel one) before starting a print operation, press in on the forms tractor positioning knob to disengage the forms tractor clutch, and depress the restore key. (The restore operation takes place as the Restore key is released.)

Stop Key (Figure 89)

When this key is depressed, the carriage operation stops immediately and the printer stops at the completion of the print line. It is normally used to stop the flow of paper after the restore key has been depressed. It also stops runaway skipping which can result from improper insertion of tape, wrong tape, impulsing a skip-to for which no channel is punched, etc.

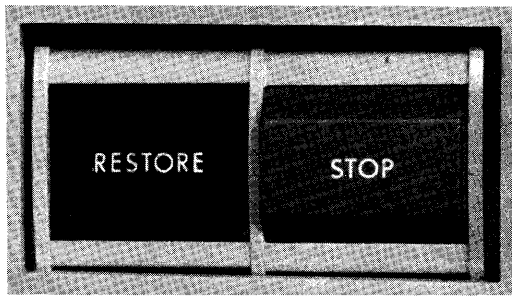

Figure 89. Carriage Control Keys

Print Repeat Switch

The Print Repeat switch on the 370 Printer allows manual repetitive printing of information from the output track. It is located on the left-hand side under the top cover (Figure 90).

This switch is particularly useful when testing new control panel wiring, or repeating a line that was printed in error. When format is controlled from coding on the output track, a record can be loaded on the output track (S), and printer format can be tested by depressing the Print Repeat switch. Each depression of the button causes a print cycle.

Depression of the Print Repeat switch removes the printer from a ready status. To restore the printer to a ready status, the Printer Start key must be depressed.

In case of a Δ STOP operation, the Print Repeat switch may be used to cause the printer to repeat the printing of the record on the output track for error correction. If the error occurs during an MLP operation, the printer will stop after printing the Δ . Successive depressions of the Print Repeat switch will cause succeeding MLP lines

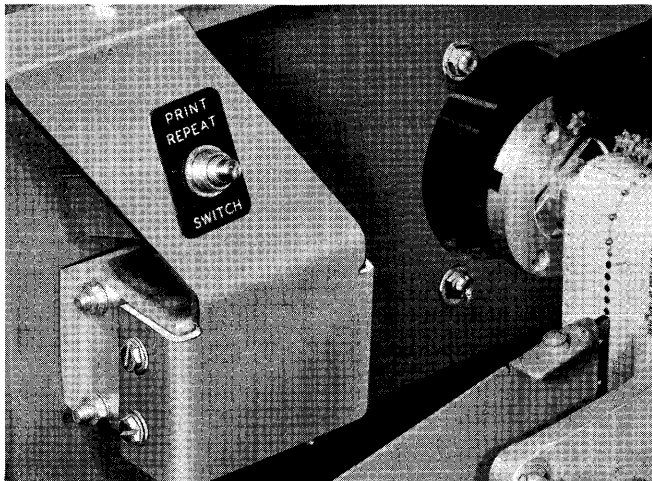

Figure 90. Print Repeat Switch

to be printed. After the last MLP line is printed, the complete MLP cycle may be repeated by further depressions of the switch.

Inserting a New Form

To insert a new form, lift the top cover and open the left-hand front door. Paper may be inserted by sliding it up between the form feed guide plates. To lock the paper in position, move the pressure plates away from the tractor pins, position the form, and lower the pressure plates. After positioning the form for the first printing line, the forms tractor may be restored to the home position (channel one) by disengaging the forms tractor clutch and depressing the Restore key.

Form Thickness Adjustment Device (Figure 91)

To compensate for various thicknesses of paper stock or for varying numbers of copies, a form thickness adjustment device is provided. This device is located behind the print head and is accessible through the rear cover. Three notches are provided. For heavier impressions, pull the lever away from the front of the machine.

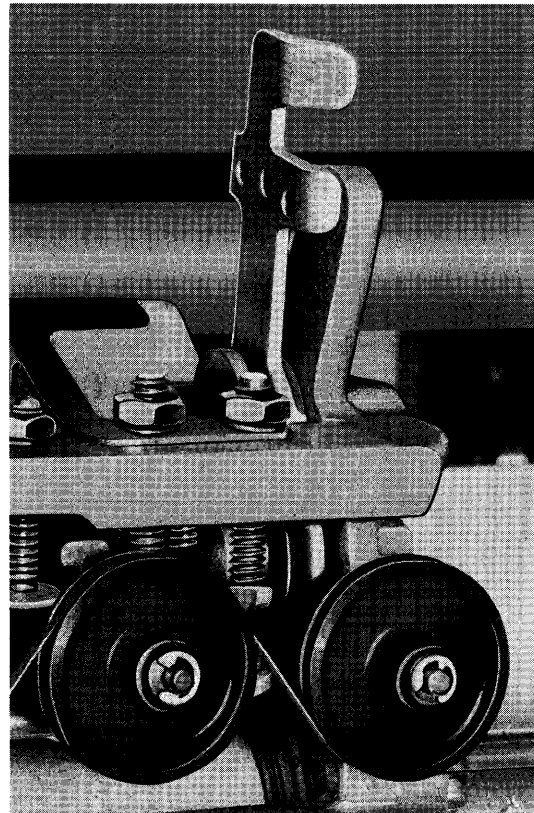

Figure 91. Forms Thickness Adjustment Device

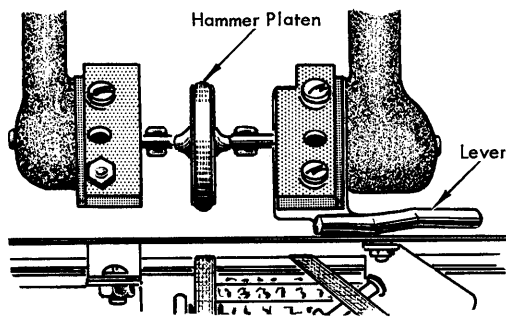

Figure 92. Printer Platen

Changing Hammer Platens

Two 370 hammer platens are available, one soft and one hard, to accommodate differences in paper stock, carbon copies, etc. A hard platen should not be used with 1 to 4 part forms, because it will tend to emboss the forms.

Pulling up on the lever (Figure 92) will raise the clamps holding the platen in place and make it possible to lift the platen out.

To insert another hammer platen, lift the lever again, and while holding it upright, slip the new platen into place watching to see that the spindle on which the platen rotates fits into the grooves on both sides.

Changing the 370 Printer Ribbon (Figure 93)

To change the 370 Printer ribbon, proceed as follows:

1. Stop the machine by turning the power switch off.
2. Slant the Ribbon Reverse lever *away* from the fullest reel, and wind the ribbon onto it.
3. Remove the full reel.
4. Place the new reel of ribbon on the empty spindle.
5. Loop the loose end of the ribbon around the Ribbon Thread Post. Holding one end of the ribbon in one hand and grasping the other side of the loop with the other, slide the loop unit both ends are between ribbon guides B and C. Thread the ribbon *over* guides B, C, D, and slide the right side *under* guide E; slip both sides under the ends of the Ribbon Reverse lever, and thread the ribbon *over* guides A and F. (Make certain that the metal rivet in the ribbon is between the spool and the ribbon reverse lever.)
6. Remove the empty spool.
7. The metal catch on the loose end of the ribbon should be placed in the slot of the empty reel.
8. Replace the reel on the spindle.

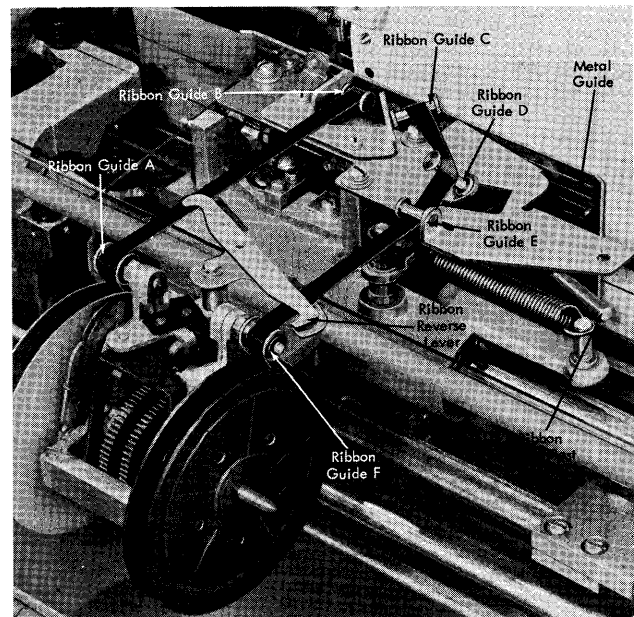

Figure 93. 370 Printer Ribbon

To Locate the First Printing Line

Set the form so that the desired printing line is underscored by the metal guide (Figure 93); move the carriage back four spaces; disengage and restore the carriage by pushing in on the carriage control knob and depressing the Restore key. The printer form will then be properly aligned.

If the form is to be set up to print on a line which does not correspond to channel 1 in the carriage tape (hence tape is not restored), the procedure is the same as for the first printing line except that the carriage should be moved back 5 (6 for double space, and 7 for triple space) spaces from the metal guide. This is necessary because the printer normally spaces once just prior to printing.

FORM CONTROL

SKIPPING IS initiated by wiring on the control panel and stopped by holes in the tape. The following examples show operating principles only. Form design will dictate each individual arrangement.

The carriage SKIP-TO hubs are impulsed from ANALYZER EXITS or from 305 control impulses wired through communication channels to cause the tractor to feed the paper in the printer to the corresponding hole in the

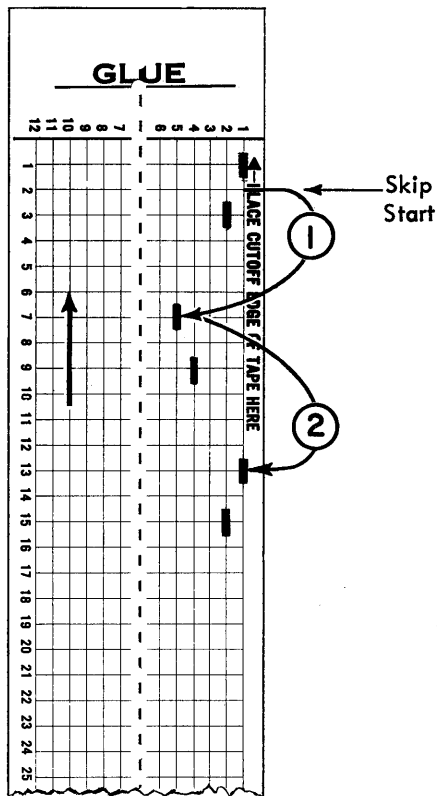

Figure 94. Carriage Skipping

control tape. Tape channels 1-6 stop the corresponding skips. (Channels 7-11 are available as a special feature.)

To skip before printing, SKIP-TO on the printer control panel must be impulsed before the PRINT hub on the process control panel is impulsed by using a cycle delay. If SKIP-TO is impulsed after the print cycle has started, skipping will occur after printing. When skipping is initiated during the analysis portion of the print cycle, the skip will occur after printing.

If conflicting SKIP-TO instructions are given during the same print cycle (or between two successive impulses wired to PRINT), each of the skips will take place in succession. The skipping operation will continue until all the skips called for have been completed by sensing the corresponding holes in the carriage tape. There is no precedence of one skip over another; therefore, when laying out a carriage tape, it should be remembered that the skip operation will not be complete until the last hole in the tape which satisfies all SKIP-TO's impulsed has been reached.

If SKIP-TO 5 and SKIP-TO 1 are both impulsed on the same print cycle (Figure 94):

1. The carriage skips until the five is sensed and the SKIP-TO 5 is satisfied.

2. The skip continues on until the 1 is sensed at which time the skipping is stopped because all SKIP-TO's have been satisfied.

Figure 95 illustrates skipping before printing.

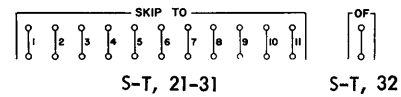

OF (overflow). Channel 12 on the tape is reserved for overflow control. It is punched to identify the last printing line on the form. When it is sensed — during the analysis portion of the cycle — an impulse is available out of the OF hub. This impulse may be wired to cause the paper to be skipped to the first line of the following form by impulsing one of the SKIP-TO hubs, and placing a hole in the control tape in that channel to stop the form at the proper place.

The OF impulse may also be wired through communication channels to the processing control panel, where it may pick up a selector that is tested in the course of the program to determine if the overflow condition exists; then steps in the program can decide whether to complete the form or start the following form.

Variable line spacing within the body of a form will require multiple 12 punches in the carriage tape for overflow so that the overflow position will not be bypassed during a double or triple spacing operation.

Printing Indicative Information (Figure 96)

Figure 96 illustrates in block form one method of printing indicative information at the beginning of each new overflow sheet of an invoice. In this example, the stored program is controlled by a selector on the process control panel. The selector is picked up by wiring the overflow impulse through one of the communication channels.

Because spacing occurs after the print cycle has already been initiated — during the analysis portion of the cycle — the last line on the sheet, which corresponds to the overflow line, will have already been set up for printing before the overflow impulse is available. Therefore, the last line on the form will print, but the selector that is picked up by the overflow impulse will be transferred the next time the program reaches that point.

When the overflow selector is tested the next time, the program will be directed to the overflow routine. The

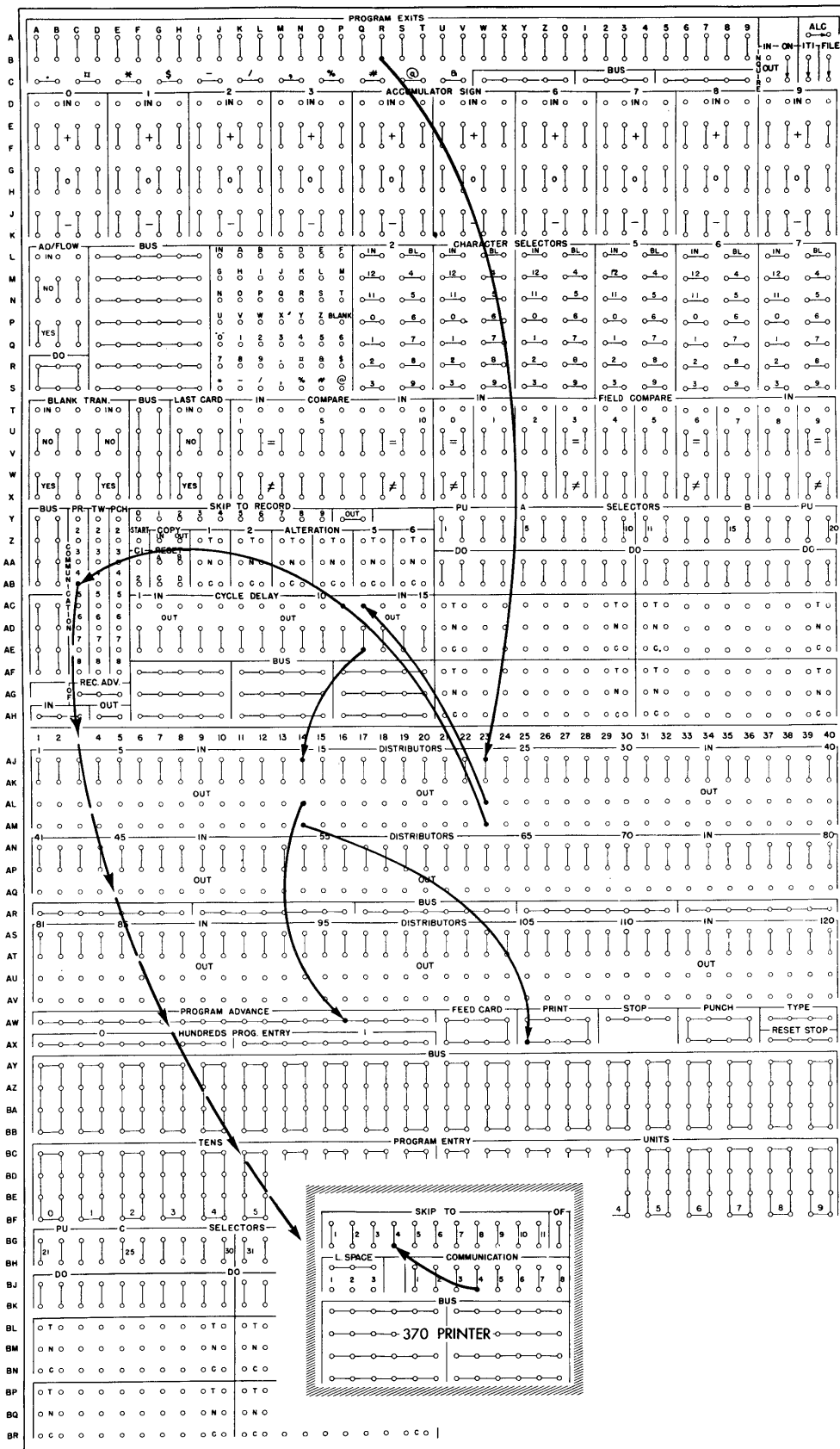

Figure 95. Skip Before Print

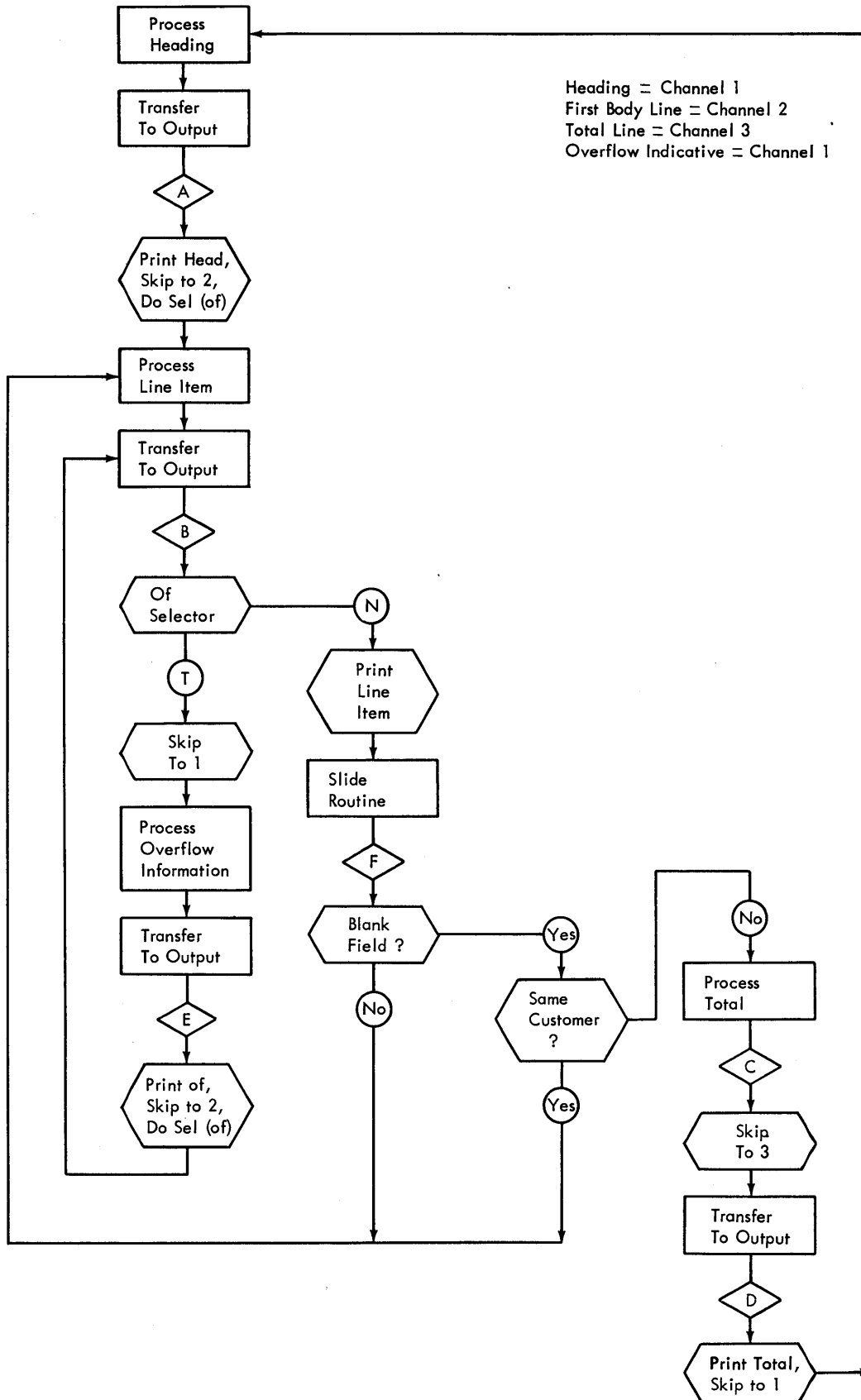

Figure 96. Printing Overflow Indicative Information

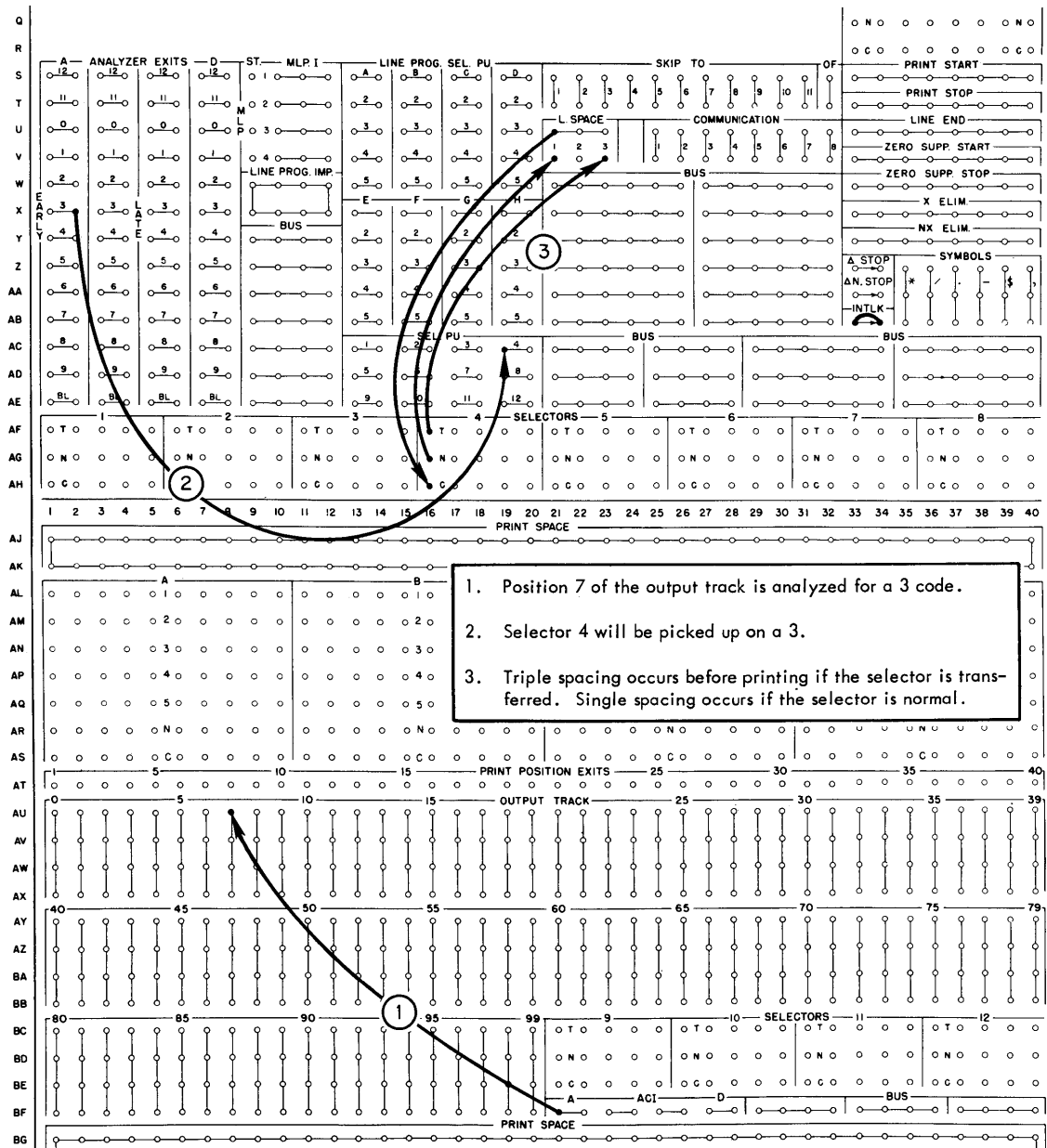

Figure 97. Selective Spacing

form is skipped to the heading location on the next sheet; the overflow indicative information is transferred to the output replacing the body line information; printing is initiated; the overflow selector is dropped out; and the form is skipped to the first body line.

The program is then directed back to a point where the previous body line information is again transferred to the output. The program will then proceed through the path taken when the overflow selector is normal.

The slide routine referred to is included for a typical spread-card and blank-field-check routine.

Line Space. The line space hubs 1, 2, and 3 (exit hubs) are jackplugged to the common hubs located directly above them to cause single, double, or triple spacing between lines on a form. If LINE SPACE 1 is wired, single spacing will occur; if LINE SPACE 2 is wired, double spacing will occur, etc.

GENERAL MANUFACTURING CO.
SAN JOSE, CALIFORNIA

Ship To THE WINSOR CORP.
127 SOUTH EIGHTH ST.
ALBUQUERQUE, NEW MEXICO

Cust. No.
191751

M D Y
12 15 6

Inv. No.
1254

Quantity	Description	Item No.	Price Each	Amount
40	SQ. SHANK SWIVEL	11202	83	33120
75	FLAT TOP RIGID	13102	84	6300
5	EXT. SHANK WITH BRK.	17203	162	810
2	BOLT AND NUT SHANK	32105	264	528
4	RND. SPR. RING STEM	44104	351	1404
40	BOLT AND NUT SHANK	62110	725	29000
	FREIGHT			78
			NET AMOUNT	41440

CUST DISK ADD	MLP	NAME	STREET ADDRESS	CITY AND STATE	DATE	INV. NO.	CUST. NO.
0	516	301	521	751	851	911	971

Figure 98. MLP Invoice

Selective spacing and space suppression may be performed. The ANALYZER EXITS are used to control the selection; however, the selection of triple spacing must be controlled by the early analyzers.

Figure 97 illustrates selective spacing.

MULTIPLE LINE PRINTING

PRINTING MULTIPLE LINES of information from the output track may be accomplished by proper wiring of the MLP unit. The number of lines to be printed are controlled by an MLP code, which may be placed in any convenient output track position as long as that position remains consistent.

To prepare an invoice heading (Figure 98) the output track is normally assembled in several different steps. After it is assembled, a print instruction is initiated. During the analysis portion of the print cycle, the MLP code is analyzed and controls are set for the printing of from one to four lines. The number of lines to be printed is

determined by the code. For example, a 1 code may cause one line to print; a 2 may cause two lines to print; a 3 may cause three lines to print, etc.

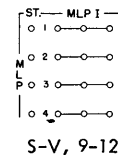

MLP. The MLP unit controls the printing of multiple lines from a single output track. The START hub is impulsive from an ANALYZER EXIT. Then, the MLP impulse, (MLP I) hubs emit an impulse which may be wired to pick up line program selectors.

The impulse wired to the START hub will usually correspond to the desired number of lines of printing; that is, a 1 will initiate a single line of printing, a 2

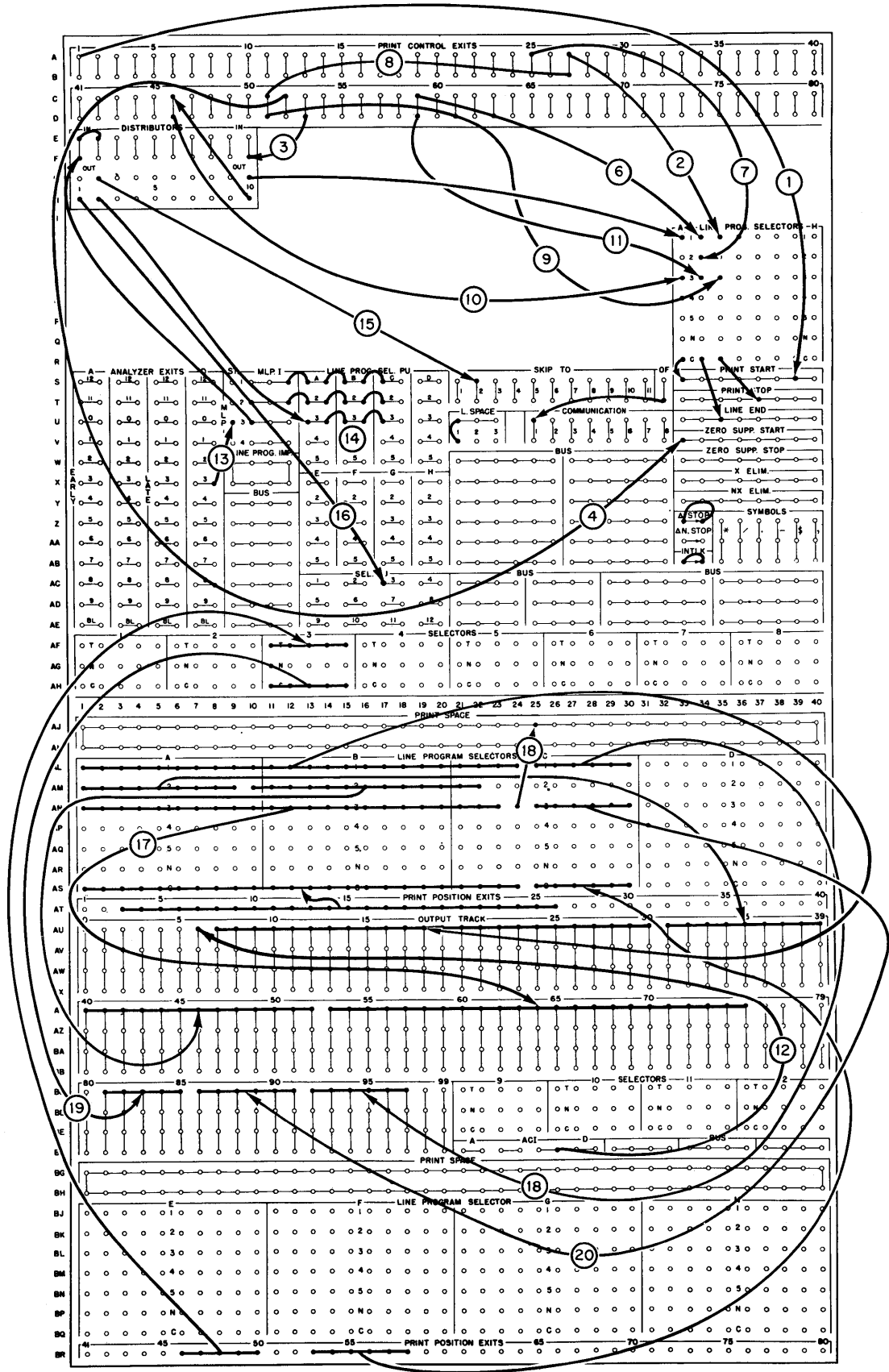

Figure 99. Multiple Line Printing

for two lines, a 3 for three lines, etc. This type of coding is convenient; however, it is not imperative. For example, a 7 could cause two lines of printing.

Once the START hub has been impulsed the MLP I hubs will emit in sequence. If the THREE START hub is impulsed, the number one MLP I hub will emit on the first line; then the two hub on the second line; and last, the three hub on the third line. If the number TWO START hub is impulsed, the number one and two MLP I hubs will emit in sequence.

Figure 99 shows the wiring necessary to prepare the three-line invoice heading shown in Figure 98. In this example, it is assumed that all invoice headings will contain three lines.

Wiring (Figure 99)

FIRST LINE PRINT CONTROL

1. Printing begins in print position 3 (wire 1).
2. Printing is stopped before printing position 27 (wire 2).
3. ZERO SUPPRESSION START is impulsed from PRINT CONTROL EXIT 52 so that it will be on for customer number (wire 4).
4. Printing of customer number begins with print position 53 (wire 3).
5. LINE END is impulsed from position 59 (wire 6).

SECOND LINE PRINT CONTROL

1. Printing begins in print position 3 (wire 1).
2. LINE END is impulsed from position 25 (wire 7).

THIRD LINE PRINT CONTROL

1. Printing begins in print position 3 (wire 1).
2. Printing is stopped before printing position 27 by wiring from PRINT CONTROL EXIT 27 to 50, and then through the line program selectors to PRINT STOP (wires 8 and 9).
3. Printing is started in position 46 (wire 10) to start printing date.
4. Printing is stopped before printing position 51 (wire 9).
5. ZERO SUPPRESSION is impulsed from PRINT CONTROL EXIT 52 so that it will be on for invoice number (wire 4).

6. Printing of invoice number begins with print position 53 (wire 3).
7. LINE END is impulsed from position 59 (wire 11).

ANALYZER WIRING

1. ANALYZER CONTROL IMPULSE for analyzer C is wired to OUTPUT TRACK POSITION 6 (wire 12). Position 6 contains the MLP code.
2. In this example it is assumed that all invoice headings contain three lines. Therefore, it is only necessary to impulse MLP 3 START (wire 13).
3. Line program selectors A, B, and C for line 1, 2, and 3 are picked up from the MLP IMPULSE hubs (wire 14).
4. After printing the third line of MLP, the form will be skipped to the position corresponding to channel 2 of the tape (wire 15).
5. Selector 3 is picked up to expand the third line of printing (wire 16).

LINE PROGRAM SELECTION

1. On the first line of printing, PRINT POSITION EXITS 3-26 are wired through the first line of the line program selectors to OUTPUT TRACK POSITIONS 7-30. On the second line of printing, PRINT POSITION EXITS 3-24 are wired to positions 31-52. On the third line, PRINT POSITION EXITS 3-25 are wired to positions 53-75 (wire 17).
2. Printing is turned off after printing position 26 on both the first and third lines (wire 2). Because, on the third line, an output track position is not wired from print position exit 26, PRINT SPACE must be wired (wire 18).
3. Customer number is directed to print through line one of the line program selectors (wiring 18).
4. Date is directed through selector 3 to print on the third line of MLP (wire 19).
5. Invoice number is directed to print through line three of the line program selectors (wire 20).

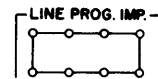

W-X, 9-12

Line Program Impulse. This impulse is available during the analysis portion of the print cycle. It is, however, inactive if MLP START has been previously impulsed.

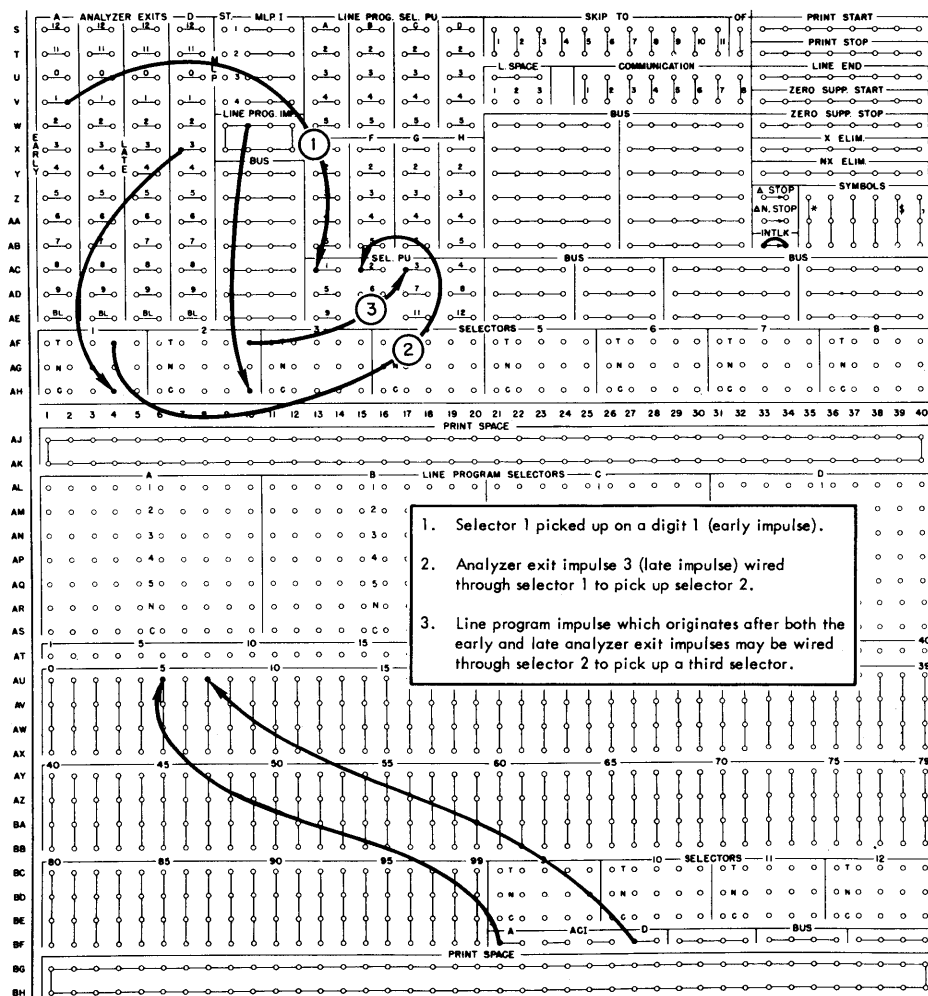

Figure 100. Series Wiring to Illustrate Timings

During an MLP operation, the MLP IMPULSE hubs emit, and the LINE PROGRAM IMPULSE hubs are inactive.

The LINE PROGRAM IMPULSE occurs after the C and D ANALYZER EXIT impulses. This arrangement allows the type of selector wiring shown in Figure 100.

TIMING CHART

THE PURPOSE of the printer timing chart (Figure 101) is to increase the general knowledge of the machine operation, and to assist experienced programmers who must resort to unusual wiring methods to accomplish a desired result. A good working knowledge of the machine is necessary before timing charts can be used effectively. The timing chart should be used in conjunction with the Control Panel Entry Summary.

All impulses shown on the timing chart with the ex-

ception of the PRINT CONTROL EXITS and PRINT POSITION EXITS happen only once during the over-all print cycle. These impulses which happen only once occur during the analysis portion of the cycle. The analysis portion of the print cycle is completed at 19.5. The first character prints at 21.5. At 32 on the index, the print shaft latches; however, the PRINT CONTROL EXITS and the PRINT POSITION EXITS continue to emit until all 80 characters have been printed or until LINE END on the printer control panel is impulsed.

The timing chart represents intervals of 10 milliseconds. This timing relationship may be used as a guide for picking up selectors or directing impulses through the transferred points of the selectors. In general, once a selector has been picked up, seven milliseconds should be allowed before directing an impulse through the transferred points of the selector. Impulses that are active during pickup time should not be selected.

323 Card Punch

THE IBM 323 Card Punch (Figure 102) may be used as an output device for the RAMAC system, or as an independent gangpunch. Information from the output track is directed by the control panel to punch cards in any desired format.

During continuous operation, up to 100 cards per

minute may be punched. Each card requires six hundred milliseconds.

It is possible to perform gangpunching, double-punch and blank-column detection, column splitting, etc. However, because X-control is not provided, it is not possible to perform operations such as interspersed gangpunching.

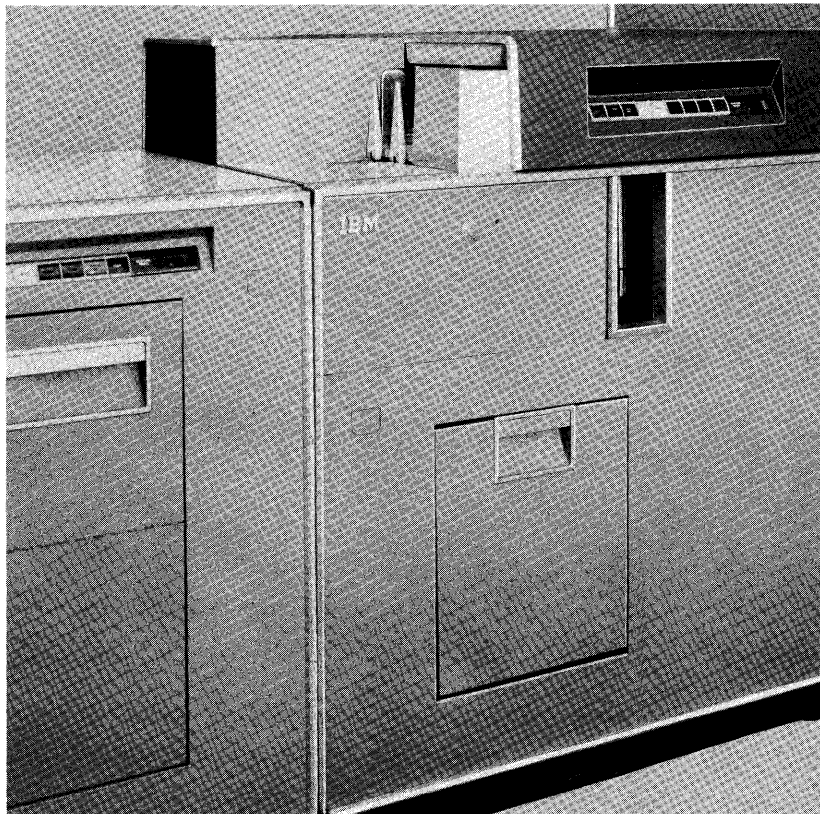

Figure 102. 323 Punch

OPERATING KEYS AND LIGHTS

THE FOLLOWING operating keys and lights are located on the punch unit (Figure 104):

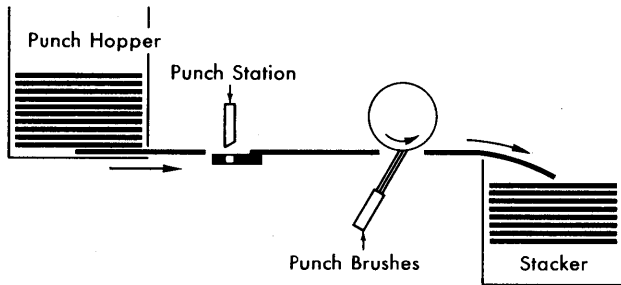

Figure 103. Punch Feed Schematic

FEED AND PUNCH UNIT

THE FEED is illustrated in Figure 103. Up to 80 characters of information may be punched into each card as it passes the punch station. Gangpunching and double-punch and blank-column detection are performed at the punch brush station.

The initial run-in of cards into the machine—face down, 12-edge first—may be accomplished by holding the start key down until the ready light comes on. However, if the run-in is performed one cycle at a time, a single depression of the start key will feed the first card partially out of the hopper; the second depression of the start key feeds the card past the punch station; on the third depression, the ready light will come on, but the cards do not move. Because one card passes the punch station during run-in before any processing actually takes place, there will always be one blank card preceding each new group of cards.

During continuous operation, the output track is read in its entirety when the card is positioned for punching at each of the zone and numeric portions of the card. For example, when the card is in position to punch all 12 zones, all 100 positions of the output are read; however, only those positions that contain a 12 are selected for punching. This same sequence is repeated when the card is in position for punching the 11 zones, 0 zones, 1, 2, etc.

Keys

Start. The start key will feed cards into or out of the punch feed. It is also depressed to place the punch in a ready condition if cards are at each station.

Stop. Depressing this key during a punch cycle will stop the punch at the completion of that cycle and remove it from a ready condition. The program or process unit will stop as soon as the program refers to the output track.

Check Reset. Depressing this key will restore the punch-error-detection circuits. It is used to reset parity, and double-punch and blank-column error indications.

Main Line Power. This switch is used in conjunction with the console power-on key to supply or remove power from the punch.

Lights

Ready. This light will glow when the punch is ready for use by the processing unit. It is turned on by depressing the Start key if the cards are at all stations, and all error-detecting devices are reset.

Feed Check. This light indicates a misfeed in the punch feed. If a card failed to feed from the hopper into the machine, remove the cards from the hopper and run the remaining cards out of the machine. Then proceed through a normal run-in procedure. Misfeeds at the other stations will require individual correction procedures.

Parity. Each of the 100 positions of the output track is parity checked before punching occurs. If any position fails to pass this parity check (including those positions not being punched), the parity light will glow, and the punch will stop at the completion of the punch cycle.

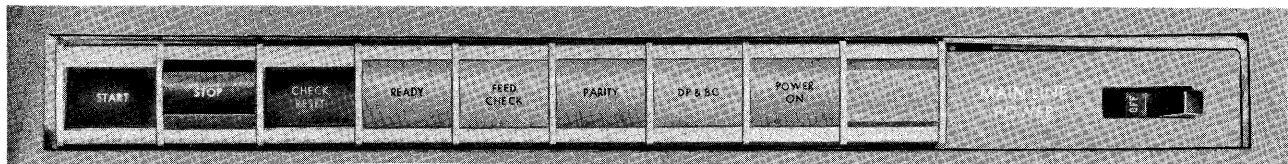

Figure 104. 323 Punch Operating Keys and Lights

DPBC The punch control panel may be wired to stop the machine and turn this light on when either a double-punch or a blank-column error is detected.

Power-On. When AC and DC power have been supplied to the punch, this light will glow.

323 CONTROL PANEL

THE FOLLOWING hubs are located on the punch control panel (Figure 105):

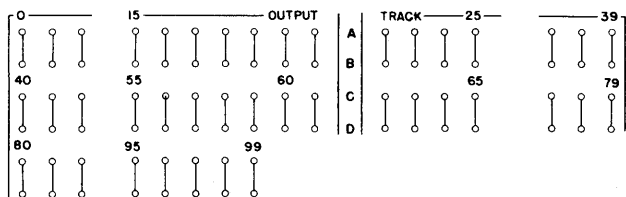

A-D, 1-40
E-F, 1-20

Output Track. Each of these 100 hubs correspond to a position of the output track. The hubs emit information in the standard IBM punched-card code form. These exits are wired to the PUNCH MAGNETS to cause punching. This allows any of the 100 output track positions to be punched into any of the 80 card columns.

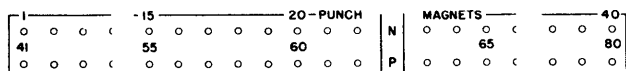

N-P, 1-40

Punch Magnets. These hubs are entries to the 80 punch magnets that punch the correspondingly numbered columns of the card. These magnets are wired from the OUTPUT TRACK positions that are to be punched.

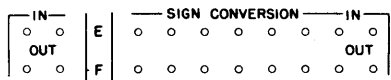

E-F, 21-30

Sign Conversion. Within the RAMAC system the 12 card code is recoded by a combination of X- and 0-bits. Also, sign control on negative fields is maintained by carrying an X-bit over the low-order position. If the low-order position of a field is zero and the field is negative, a 12-hole would be punched if this position were wired directly to a punch magnet. The sign conversion hubs are provided so that the 12-impulse available from the output track may be converted to the X/0 code desired for these positions.

In use, the low-order position of any numerical field that may be negative is wired from the output track to an IN hub and from the corresponding OUT hub to the punch magnet. If a 12-code is emitted from this position of the output track, it is punched as X/0. Any other negative number is overpunched with an X. Positive numbers pass through without conversion.

Figure 106 illustrates the type of wiring necessary to punch output information. If there is a possibility of the output track containing a negative figure, the units position should be wired through sign conversion.

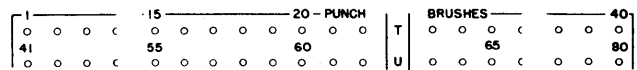

T-U, 1-40

Punch Brushes. On the punch cycle after a card has been punched, it passes a set of 80 reading brushes that read back the information that has been punched so that it may be given the double-punch blank-column check. These hubs are the exits for the reading on this cycle. The information may also be gangpunched back into the following card.

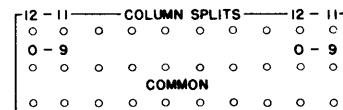

G-J, 31-40

Column Splits. This is a 10-position selector that is automatically controlled to transfer between X and 0 time as each card is punched. This allows the separation of the digits 0-9 from the 12- and X-zones. For example, if the character A were wired to the common of a COLUMN SPLIT position, the numerical digit 1 would emerge from the 0-9 hub, and the 12-zone would be available at the 12-11 hub.

Figure 107 illustrates a method of using the COLUMN SPLIT device to punch an X over the high-order position of a field.

Double-Punch and Blank-Column Detection

The 323 Card Punch is equipped with 20 positions of DPBC detection as a standard feature. Up to 60 additional positions are available as a special feature. By appropriate control panel wiring, it is possible to detect the presence of either multiple punches in any single column or the absence of any punch in a column or both.

323 PUNCH CONTROL PANEL
(IBM 305 RAMAC_®)

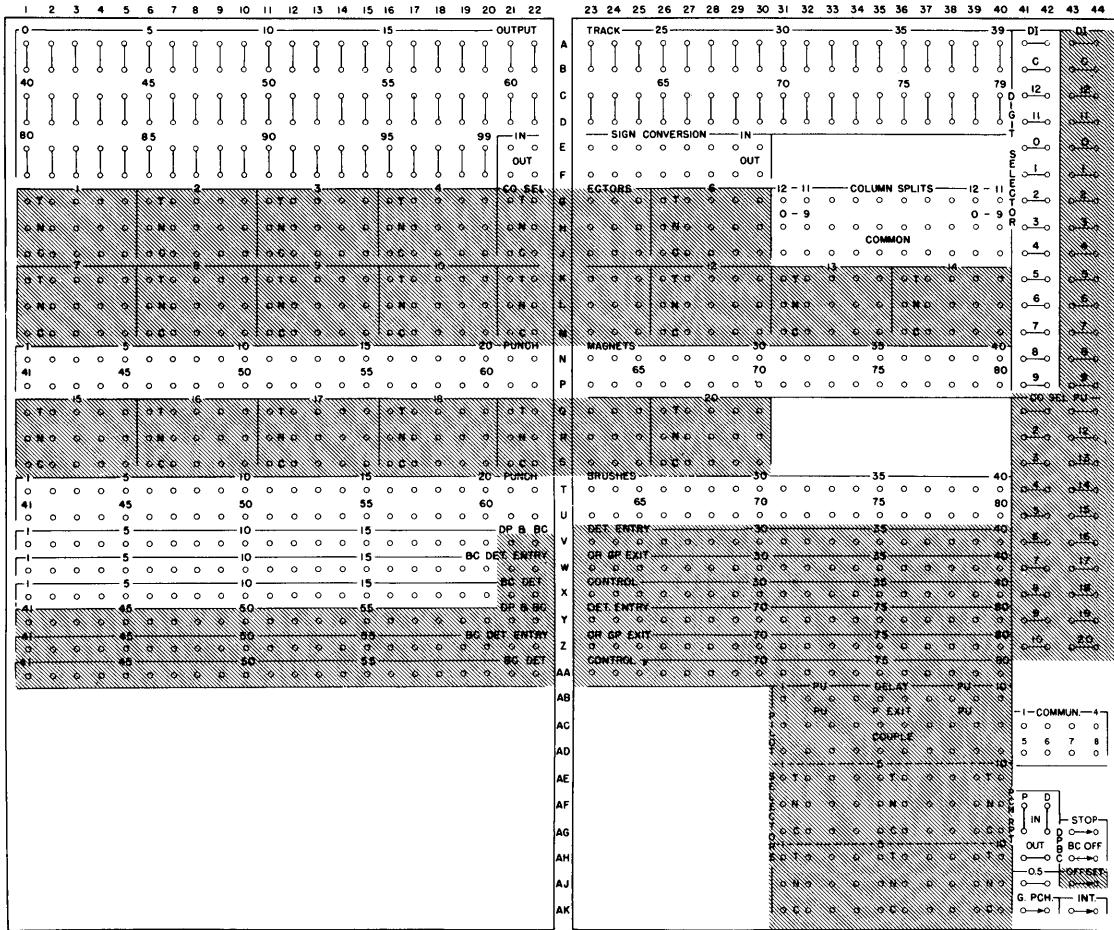

Figure 105. 323 Punch Control Panel

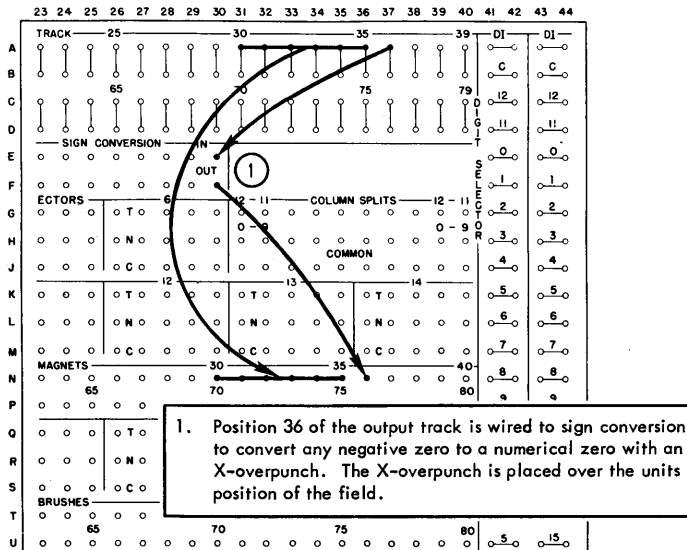

Figure 106. Sign Conversion

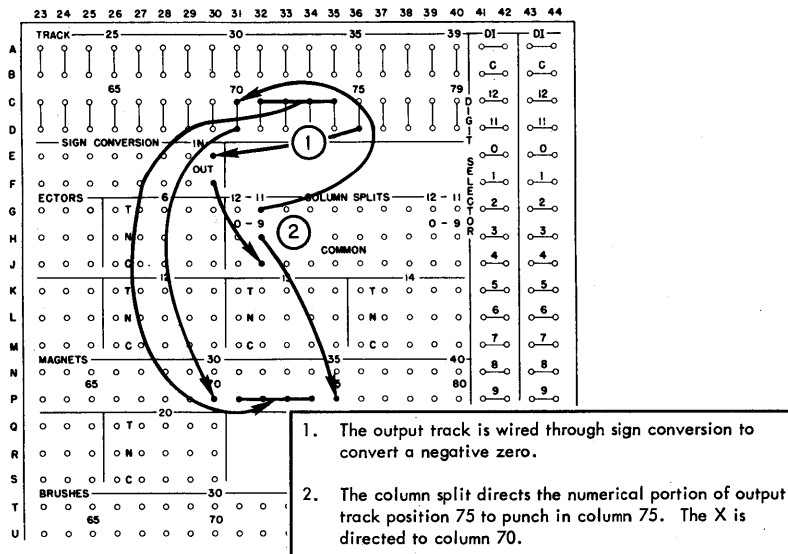
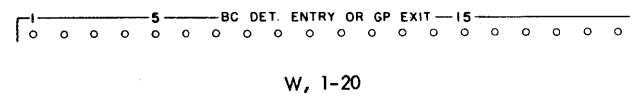
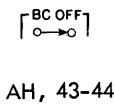
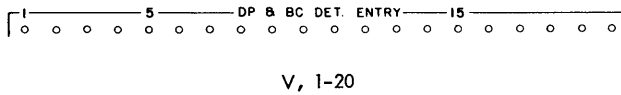

Figure 107. Punch Negative X over High-Order Position



BC OFF (blank column off). When this switch is wired, blank columns will not be detected by the DPBC device. If these hubs are selected, a co-selector must be used.

BC Det Entry or GP Exit (blank-column detection entry or gangpunch exit) Figure 109. These hubs may be either entries or exits. As entries, they are used to detect blank columns in the output cards without double-punch detection. When these hubs are used, only the first punch of a multiple punched column will be emitted from the BC DET ENTRY or GP EXIT.



As exits, they are wired to the punch magnets for gangpunching. When used as gangpunch exits, only the first digit of any column wired to a DP or BC DET ENTRY hub will be available at the associated GP EXIT hub.

DP & BC Det Entry (double-punch and blank-column detection entry) Figure 108. These hubs are entries for the digit impulses from the punch brushes. They are used to detect double-punched or blank columns in the output cards.

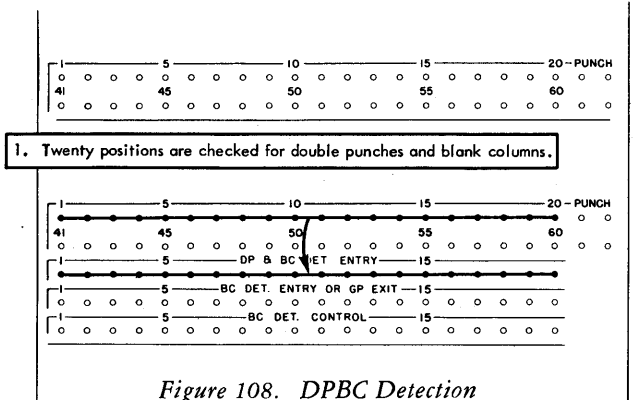

Figure 108. DPBC Detection

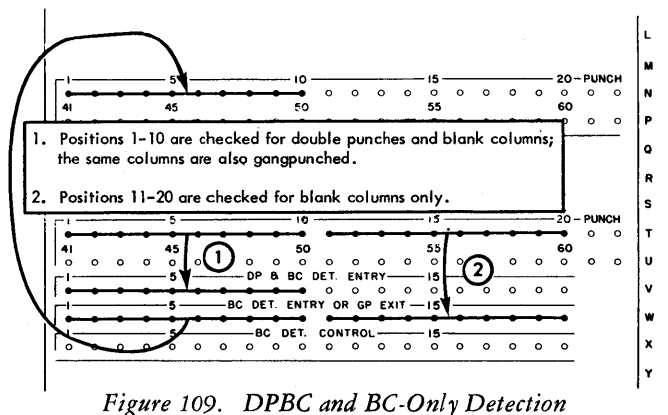

Figure 109. DPBC and BC-Only Detection



X, 1-20

BC Det Control (blank-column detection control Figure 110.) These hubs provide a means for control of blank column detection. All positions of DPBC are internally connected for blank-column detection. It is possible to bypass any particular position or positions that are not to be checked for blanks by control panel wiring in the following manner: The BLANK-COLUMN DETECTION CONTROL hub for the last position, in which blanks are to be checked, is connected by a control panel wire to the BLANK-COLUMN DETECTION CONTROL hub preceding the next position which is to be checked for blanks.

If it is necessary to bypass checking for blanks in the last position (position 20 for standard machine), the BC DET CONTROL hub for the last position in which blanks are to be checked must be connected by a control panel wire to the BLANK-COLUMN DETECTION CONTROL hub for the last DPBC position. (Wire 3, Figure 111). Any selection of these hubs must be through co-selectors.

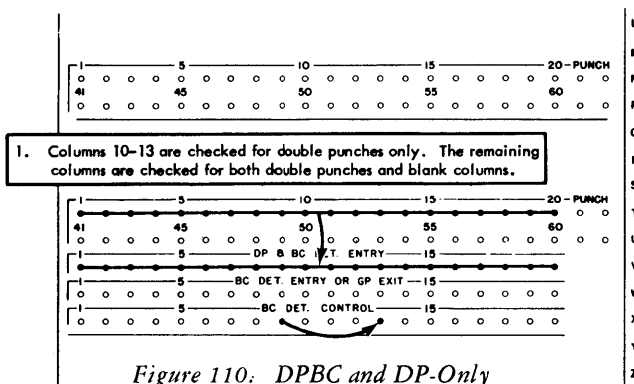

Figure 110. DPBC and DP-Only



AG, 43-44

DPBC Stop (Figure 111). When this switch is plugged, either (or both) a blank-column or a double-punch error will stop the machine. The DPBC light on the punch will be turned on. In addition, the interlock and punch select light will be turned on at the 380

console. If these hubs are selected, a co-selector must be used.

Other Control Panel Functions

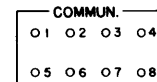

AC-AD, 41-44

Communication. These hubs are connected to the correspondingly numbered hubs labeled *Punch Communication* on the process control panel.



A, 41-42

G. Punch (gangpunch). When this control-panel switch is jackplugged, the 323 punch is removed from the control of the processing unit and may be used as an independent gangpunch.



AK, 43-44

Int. (interlock). Whenever the punch is to be used to punch output cards for the processing unit, this control panel switch must be jackplugged. It is not plugged if the punch is to be used for independent operation.



A, 41-42

DI (digit impulse). This hub emits all digit impulses (12 through 9) every punch feed cycle.

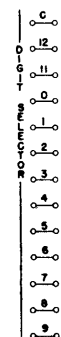

- B-P, 41-42 -

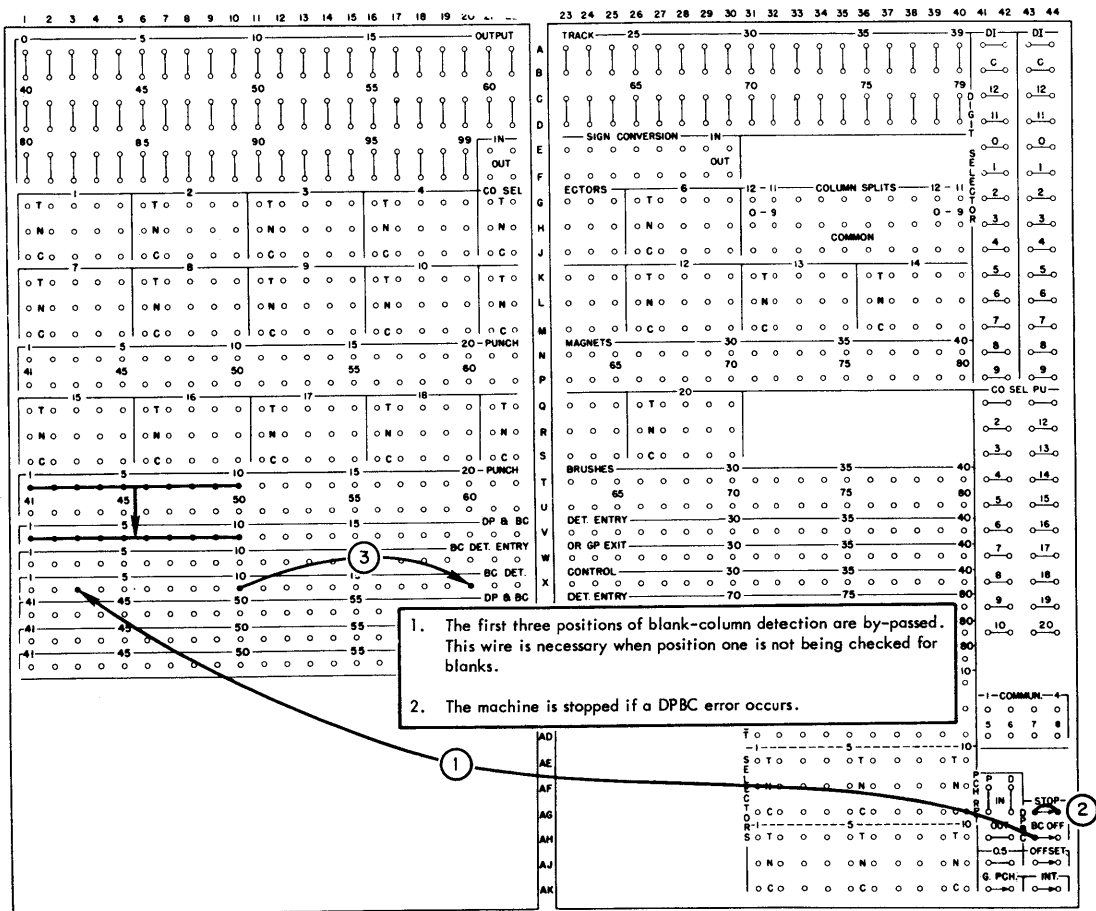

Figure 111. Double-Punch and Blank-Column Detection

Digit Selector. One digit selector is standard with the 323 punch. It may be used to separate or combine multiple digits. In addition, it may be used to select specific digits from the output track or punch brushes.

When the DI impulse is connected to the common of the digit selector, it becomes a punch digit emitter with a 12 impulse available out of the 12 hub, 11 impulse at the 11 hub, etc.

Figure 112 illustrates using the digit selector as a digit emitter.

Punch Repeat

When an impulse is wired to Punch Repeat IN (P or D), one additional card will automatically be punched from the same output track data.

If selectors are used, two cards with different formats can be obtained from the single output track. Without

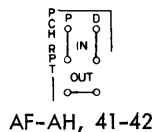

selectors, two identical cards are punched.

When Punch Repeat has been impulsed, the OUT hub on the Punch Control Panel will emit just prior to punching time of the second card. This impulse may be wired to the DEL pickup of Pilot Selectors or to Co-selector pickups to control the punching for the second card.

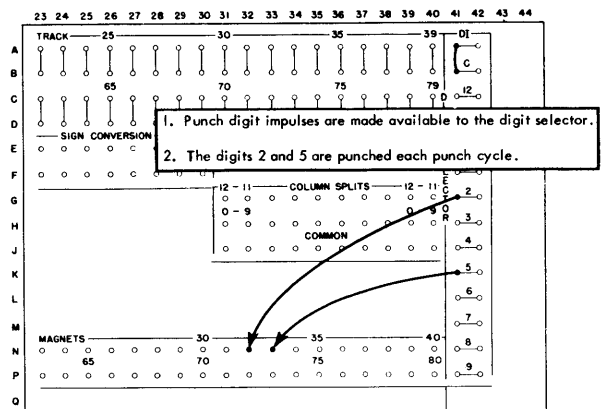

Figure 112. Digit Emitting

A Program Exit wired through a Communication Channel for the purpose of impulsing Punch Repeat must be wired to the P (Program Exit) IN. Also, the Program Exit that is wired to Punch Repeat must be the same Program Exit that is wired to PUNCH on the Process Control Panel.

Digits or Couple exits used to impulse Punch Repeat must be directed to the D (digit) IN for correct operation. As in the case of the P IN, when the D IN of Punch Repeat has been impulsed, the OUT hub will emit just prior to punching time of the second card.

More than one additional card can be punched by impulsing Punch Repeat D IN on successive cycles. The number of additional punch cycles can be controlled by the use of Pilot Selectors.

Punch Repeat will maintain its proper status during restart procedures.

0.5 (Half-After-Zero Impulse)



AJ, 41-42

This hub emits an impulse after zero time but before one time. It may be used to transfer selectors so that only the digits 1-9 are punched, or to separate the zone and numerical punching of alphabetic fields so that they can be wired for DPBC detection.

TIMING CHART

THE PURPOSE of the punch timing chart (Figure 113) is to increase the general knowledge of machine operation and to assist experienced programmers who must resort to unusual wiring methods to accomplish a desired result. A good working knowledge of the machine is necessary before this timing chart can be used effectively.

As shown in Figure 113, the punch cycle has been divided into fourteen equal parts called "Points." The points are numbered on the timing chart in the following sequence: 12, 11, 0, 1, 2, 3, 4, 5, 6, 7, 8, 9, 13 and 14. Points 13 and 14 represent the space between cards, and points 12 through 9 correspond to the reading and punching of the card.

A card cycle starts at 14.5 (midway between 14 and 12) and ends 14 points later at 14.5. The punch clutch latches at 14.5.

As a general rule, at least two-tenths of a cycle point should elapse between the time a selector is picked up until an impulse is directed through the transferred points. If this rule is not observed, arcing or damage to the selector points will result. In addition, the impulse may travel through both the normal and transferred points of the selector resulting in incorrect operation. For example, the timing chart shows that a selector would be damaged if the selector pickup is impulsed from a Pilot Selector COUPLE, and Punch Repeat OUT is wired through the transferred points—two-tenths of a cycle point difference is not provided.

Notes:

1. If a Pilot Selector is transferred as a result of impulsing the P EXIT pickup from a Program Exit, the COUPLE hub will emit just prior to punching time for that card. If a Pilot Selector is picked up by impulsing the DEL (Delay) pickup, COUPLE will emit on the following cycle just prior to punching time.

2. The Program Exit timing as shown illustrates a Program Exit which is wired to both PUNCH and through a Communication Channel. If the same Program Exit that is wired to PUNCH is not used, the impulse may occur anywhere in the over-all punch cycle, but it is always of the same duration (10 milliseconds).

3. A negative zero and a 12 are coded the same in the RAMAC (by an X and 0 bit combination). Therefore, when an Output Track position which contains a negative zero (12 impulse in IBM code) is wired to Sign Conversion IN, it is automatically recoded to an 11 and a 0 and becomes available at the Sign Conversion OUT hub. If it does not receive a 12, all impulses directed to the entry are available at the corresponding Sign Conversion OUT. If it does receive an alphabetic character containing a 12, only the 11 and 0 will be available at the corresponding Sign Conversion OUT hub.

4. A Co-selector remains transferred until 13.9 regardless of when it is impulsed.

5. After the DEL pickup of a Pilot Selector is impulsed, the Pilot Selector transfers at 13.4 of the same cycle and remains transferred until 9.7 of the succeeding cycle.

6. The P EXIT pickup of a Pilot Selector should be wired (through a Communication Channel) from the same Program Exit that is wired to PUNCH on the Punch Control Panel. This insures that the selector will be transferred during the correct punch cycle.

- EXIT
- ▬ VARIABLE LENGTH
EXIT: Begins anywhere in light area,
always lasts to end of dark area.
- ▬ FIXED LENGTH
EXIT: But may occur anywhere within
area indicated by arrow.

TIMING CHART, 323 PUNCH

EXITS

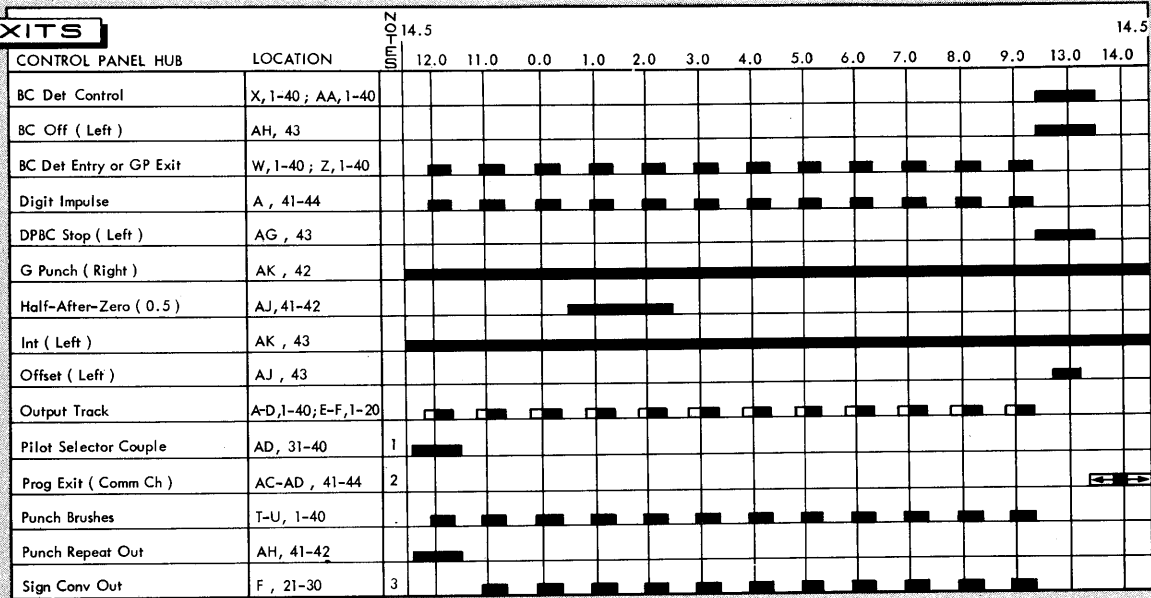

- ▬ NORMAL ENTRY
- ▬ OTHER ENTRY

ENTRIES

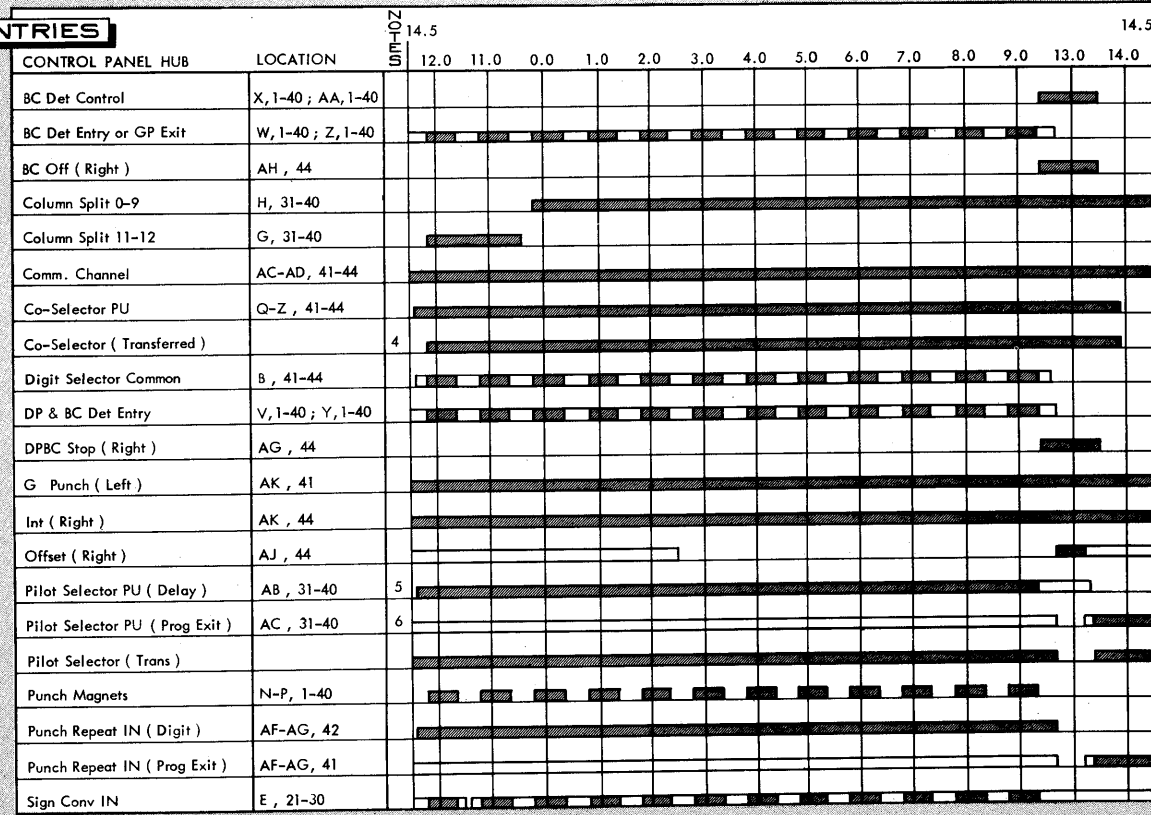

Figure 113. Timing Chart — 323 Punch

Error Correction Procedures

WHEN an error occurs during processing, the operator must take corrective action and restart the operation. Restart procedures vary depending on the type of error encountered, the type of instruction being executed, the portion of the instruction on which the error occurred, and the general configuration of the program. It is important that the programmer understand thoroughly each type of error condition and the procedure necessary for restarting in order to write a program compatible with error correction procedures. Proper planning for error restart will reduce the amount of time required to correct errors, and will insure that the function of the program for each item is not altered by the error routine.

The following restarts are outlined giving the console or machine indication, the cause of the error, and the restart procedure:

PROCESS ERRORS:

- Parity Check Stop
- Clock Error
- File Check Stop
- Feed Check
- Read Check Stop
- Interlocked Track (Input or Output)

PRINTER ERRORS:

- Print Check Error (Parity or Print Setup Error)
- Form Light

PUNCH ERRORS:

- Parity Error Stop
- Feed Check Stop
- DPBC Error Stop

PROCESSING ERRORS

PROCESSING ERRORS include all errors other than those which may occur at the Printer or Punch. A large majority of processing errors can be corrected by (1) depressing Check Reset and (2) restarting the program by depressing Program Start. When an error occurs during an arithmetic operation, further analysis is generally necessary to insure that accumulator totals have not been altered and that the re-execution of instructions will not cause false totals to be accumulated. It may be necessary in many cases to restart at some point in the program where the accumulators are reset and accumulations start again.

Other areas which require caution on the part of the operator are instructions which cause cards to feed,

printer or punch operations and slide routines. Re-execution of the instruction may cause data to be duplicated or lost.

In each case, where the restart procedure varies from a simple Check Reset and Program Start, the programmer should itemize the specific steps that the operator must follow in correcting the error and restarting the program.

Parity Check Stop

Console Indication:

1. Processing stops (Red Stop light on).
2. Parity light on.

Cause:

Improper character transfer within the processing unit.

Restart Procedure:

1. If the parity check occurred on the INSTRUCTION cycle, the machine will stop with the INSTRUCTION CYCLE light on. The operator may attempt the transfer again by depressing Check Reset and then Program Start. This is possible because no information has actually transferred and the records in the machine have not been affected.

2. If the parity check occurred on the FROM cycle, the machine will stop with the FROM CYCLE light on. Depressing Check Reset and Program Start may be all that is necessary unless an accumulator read-out and reset instruction is involved. If read-out and reset has occurred, the accumulator has been reset to zero. The accumulator data is retained in the magnetic-core unit and can be used as an aid to reconstruction. It will normally be necessary to restart the program at some previous instruction so that the accumulation can be built up again. If an error persists on a track to track transfer, it is an indication that the source data is incorrect. A method for correcting invalid characters on the drum is given in the *Console Operating Procedures*.

3. If the parity check occurred on the TO cycle, the machine will stop with the TO CYCLE light on. Depressing Check Reset and Program Start is all that is necessary

unless a read-in to an accumulator is involved. If an accumulation has occurred, transferred data is in the magnetic-core unit. Depress Check Reset and make an inquiry of the core unit. It may be possible to correct the error by comparing the accumulator data with the core information and the source record. However, if this is not possible, the program should be restarted at some previous step where the accumulator is reset and the accumulation can be started over again.

Clock Error Stop

Console Indication:

1. Processing Stops (Red Stop light on).
2. CLOCK light on.

Cause:

Some phase of machine timing is out of step.

Restart Procedure:

1. Make a note of the program step involved. **NOTE:** The console may not indicate the error until the following program step. Therefore, the restart procedure must include at least the step on which the error is indicated and also the preceding step.

2. Depress the Reset key, *not* the Check Reset.

3. Investigate the TO address track of both the error step and preceding program step to be sure data was not written in the wrong place.

4. If either or both of these steps are accumulator operations, it may be necessary to restart at a position in the program where the accumulator is reset and the accumulation can begin again.

5. Investigate the program steps which are to be re-executed to insure that information will not be lost or duplicated. For example, a slide operation, feed a card, punch a card, etc.

6. Set the Program Selector to start at the restart point, and depress program set.

7. Start the program by depressing Program Start.

File Check Stop

Console Indication:

1. Processing Stops (Red Stop light on).
2. File Check light on.

Cause:

Record just stored on disk file does not agree with source data on drum. **NOTE:** Accumulator read-out and reset to the file is invalid and will always cause a File

Check stop. If the FILE hubs on the process panel are not wired, a File Check stop will occur on every file write operation.

Restart Procedure:

1. Depress Check Reset.
2. Depress Program Start.

Feed Check Stop

Console Indication:

1. Processing Stops (Red Stop light on).
2. Feed Check light on.

Cause:

Misfeed in the card reader. A check is made as the cards leave and arrive at each feed station. Therefore, any jam should affect only one card that has not been processed.

Restart Procedure:

1. Depress Reader Stop.
2. Remove the cards from the feed hopper.
3. Remove any jammed cards from the feed.
4. Run the remaining cards out by depressing the

Non-Process Runout key.

5. Restart by placing the last three cards (two cards if the card failed to feed from the feed hopper into the feed unit) in front of the remaining cards that are to be processed.

6. Depress the Reader Start key to run the cards in.

Read Check Stop

Console Indication:

1. Processing Stops (Red Stop light on).
2. Read Check light on.

Cause:

An error in reading or recoding the input card.

Restart Procedure:

1. Depress Reader Stop.
2. Remove the cards from the feed hopper.
3. Depress Non-Process Runout to clear the feed station. **NOTE:** The card in error is the third card from the back of the deck in the stacker after the cards are run out.

4. The last three cards to run out of the machine were not processed; therefore, place these three cards in front of the remaining cards that are to be processed. Then depress the Reader Start key to run cards into the reader.

Interlocked Track (Input or Output)

Console Indication:

1. Processing Stops (Red Stop light on).
2. Interlock light on.
3. Select light for interlock device on (Reader, Printer, Punch or Type).

Cause:

Programming has called for a transfer *to* or *from* the K track before the last feed operation has been completed, or it has called for a transfer *to* the output track before the last Print or Punch operation is completed.

Restart Procedure:

1. Determine if the interlock is due to running out of cards or paper. If so, replenish the cards or paper and depress the corresponding input or output Start key.
2. If the interlock is due to an input or output error condition:
 - a. Depress the console Check Reset key to drop out the interlocked instruction.
 - b. Process through a normal track investigation procedure as described in *Console Operating Procedures*.

PRINTER ERRORS

PRINTER ERRORS are indicated in one of three ways depending on the wiring of the printer control panel:

1. Δ -STOP: A delta (Δ) is printed on the left margin of the error line and programming stops on the next transfer-to-output instruction. The printer Check light is on.
2. Δ -N STOP: A delta is printed on the left margin of the error line, but printing continues. The printer Check light is on.
3. Stop (neither of the above wired): The program stops on the next transfer-to-output instruction. No delta is printed. The printer Check light is on.

If a Δ STOP or STOP condition occurs, the operator may cause the line to print again by using the Print Repeat switch or may investigate the output track and correct the information.

All skipping and MLP instructions are retained by the printer and will be executed in their normal sequence when the error has been reset by depressing the Reset key.

Print Check Error (Parity or Print Setup Error)

Console Indication:

Depends on printer control panel wiring.

1. Δ -N Stop: No console indication.
2. Δ -Stop or Stop.
 - a. Processing stops on the next transfer-to-output instruction (Red Stop light on).
 - b. Interlock light on.
 - c. Select Printer light on.

Printer Indication:

1. Δ -N Stop.
 - a. Check light on.
 - b. Delta printed in the left margin of the line in error.
 - c. Printer continues to print.
2. Δ -Stop.
 - a. Check light on.
 - b. Delta printed in the left margin of the line in error.
 - c. Printing stops after the error line is completed.
3. Stop: Same as Δ -Stop, but no delta is printed.

Cause:

1. A parity error was sensed during the transfer from the output track to the printer, or
2. The print stick may not have been set up properly.

Restart Procedure:

1. Δ -Stop and Stop.
 - a. Try printing the line again by depressing the Print Repeat switch. NOTE: If the printer is in an MLP operation, the Print Repeat switch must be depressed for each line of the MLP.
 - b. If the error appears again, investigate the output track (see *Console Operating Procedures*).
 - c. If the document is for internal purposes, the error line may be crossed out or all delta lines disregarded during future use of the document. Other documents may have to be redone either by reprocessing or off-line typing. NOTE: Reprocessing will not be practical in most instances because of file updating.
2. Δ -N Stop.
 - a. Examine the output documents at the end of a run for deltas, and make manual corrections where necessary.

- b. The Check light will remain on until the Reset Check key is depressed on the printer.

Form Light

Console Indication:

1. Processing stops on the next transfer-to-output instruction (Red Stop light on).
2. Interlock light on.
3. Select Printer light on.

Printer Indication:

Form light on.

Cause:

Bottom of last form is 1½ inches from print stick.

Restart Procedure:

1. Successive depressions of the printer Start key will cause the printer to print another line in order to complete the last form.
2. Insert new forms and align to first printing line.
3. Depress the printer Start key.

PUNCH ERRORS

ERROR RESTART PROCEDURES are the same for all types of punch errors. Processing always stops on the next transfer-to-output instruction, with the data which was on the output track when the error was sensed unchanged, and all punch control panel functions retaining their setting. (Selectors remain picked up, etc.)

If the cards are run-out of the punch after an error, the data on the output track will be punched into another card on the run-in. If the operator merely resets the error and proceeds with the operation, a second card is not punched.

During a parity error restart, it may be desirable to try again by running the cards out of the punch, and on the run-in, a new card is punched. This method allows the operator to correct the output track before the run-in by altering the track from the console.

Since the card with a DPBC error has passed the punch brushes, and the data for the following card is on the output track, the programmer must provide a means of saving the output data if DPBC error corrections are to be made. If the program is setup to retain the output data on a working track for one additional punch cycle, the data will be available for correction.

Care must be exercised to be sure that all error cards are corrected and that any duplicate cards are removed from the punch.

Punch-Parity Error Stop

Console Indication:

1. Processing stops on the next transfer-to-output instruction (Red Stop light on).
2. Interlock light on.
3. Select Punch light on.

Punch Indication:

1. Punch stops at the end of the punch cycle.
2. Parity light on.

Cause:

One or more of the 100 positions of the output track (including those not being punched) failed to pass the parity check.

Restart Procedures:

In general, the operator should try to punch the card again. If the error continues, either of the following procedures may be used.

Restart Without Clearing the Feed — Correct Later

1. Depress the 380 Console Check Reset key.
2. Read the output track. All 100 characters on the output track are typed, and, if the track contains an error, it will be automatically underlined.
3. Depress Program Start.
4. Remove the cards from the punch stacker to facilitate finding the error card, and depress the punch Check Reset and Start keys. The second card to reach the stacker is the card in error, and it may be corrected manually.

Correct the Error, then Restart

1. Depress the 380 Console Check Reset key.
2. Read the output track. All 100 characters on the output track are typed, and if the track contains an error, it will be automatically underlined.
3. After the full track has been typed, depress the Alter key. This will cause the typewriter to space across the page and stop under the first invalid character.
4. Type any corrections that are required.
5. Depress the Clear key after the last correction has been completed.
6. Depress the Write key.
7. Depress Program Start.
8. Remove the cards from the 323 Punch hopper, and depress the Punch Check Reset key. Run the remaining cards out of the machine with the Start key.
9. Remove the error card which will be the second card into the stacker.

10. Place the last correct punched card in front of the input deck if gangpunched data must be saved. (The first card in on a run-in is not punched.) The corrected output track information punches into a new card and programming proceeds.

Punch Feed-Check Stop

Console Indication:

1. Processing stops on the next transfer-to-output instruction (Red Stop light on).
2. Interlock light on.
3. Select Punch light on.

Punch Indication:

Feed Check light on.

Cause:

Full stacker, an empty hopper, or a feed failure.

Restart Procedure:

Empty Hopper or Full Stacker.

1. Place cards in the hopper or remove cards from the stacker.
2. Depress the Punch Start key.

Feed Failure — Misfeed from Hopper

1. Remove cards from hopper.
2. Depress Start key to clear feed.
3. Remove the last punched card. The last punched card will be repunched because the information concerning this card is retained on the output track.
4. Replace the unpunched cards in the hopper. If necessary, a gangpunch master card precedes these cards.
5. Depress the Start key.

Feed Failure — to Feed Into Punch Brush Station

1. Remove the cards from the hopper.
2. Remove any damaged cards and clear the feed.
3. Remove the last punched card (this may be the damaged card). The last punched card will be repunched because the information concerning this card is retained on the output track.
4. Replace the cards in the hopper. If necessary, a gangpunch master card precedes these cards.
5. Depress the Start key.

DPBC Error Stop

Console Indication:

1. Processing stops on the next transfer-to-output instruction (Red Stop light on).

2. Interlock light on.
3. Select Punch light on.

Punch Indication:

DP & BC light.

Cause:

Either a double-punch or a blank-column error (or both) has occurred. When this type of error is signaled, the card in error has passed the punch brush station. The error can indicate that either the output punching is incorrect, or that an error occurred in a gangpunched field.

Restart Procedures:

If the output punching is at fault, it may be necessary to reconstruct the output because the information in error has been replaced on the output track with the following record. This can usually be accomplished by investigating the file or processing drum tracks, or by checking the printed document. In some cases it may be desirable to carry, in the program, the output data on a working track for one additional punch cycle. Then the operator can investigate the working track and correct the card manually.

If the DPBC stop was caused by gangpunching, the feed must be cleared and the operation restarted.

Two methods for restarting the punch after a DPBC stop are:

METHOD 1

No Gangpunched Fields Checked for DPBC

1. Depress the punch Check Reset key.
2. Depress the punch Start key. Continuous operation will be resumed. The first card to reach the stacker after depressing the Start key is the card in error. It must be corrected manually.

METHOD 2

Gangpunched Field Checked for DPBC

1. Remove the cards from the feed hopper and stacker.
2. Depress Check Reset.
3. Depress the Start key to clear the feed. The first card into the stacker is in error and must be corrected manually. The second card is not in error, but will be repunched on the run-in.
4. Place the last correct card in front of the deck (for master gangpunch information) and run the cards in with the Start key. The first card in is not punched.

Wiring and Operating Suggestions

THE PURPOSE of this section is to present wiring rules, programming tips, and operating suggestions which may be used as an aid by the programmer.

The wiring rules and load rating tables must be rigidly followed when wiring control panels. Incorrect operation can result if these rules are neglected.

WIRING RULES

CONTROL PANEL wiring, load ratings, and distributor usage rules are described in this section.

General Wiring Rule

As previously stated, *any impulse split-wired to more than one type of function must be filtered in all branches.* This rule should be emphasized. It should further be re-emphasized *that this rule applies to all control panels within the RAMAC system.*

To more clearly define a function, the 370 Line Program Selectors and Co-selectors are one function; however, Selectors and SKIP-TO are not similar functions. On the 380 Typewriter control panel, such functions as

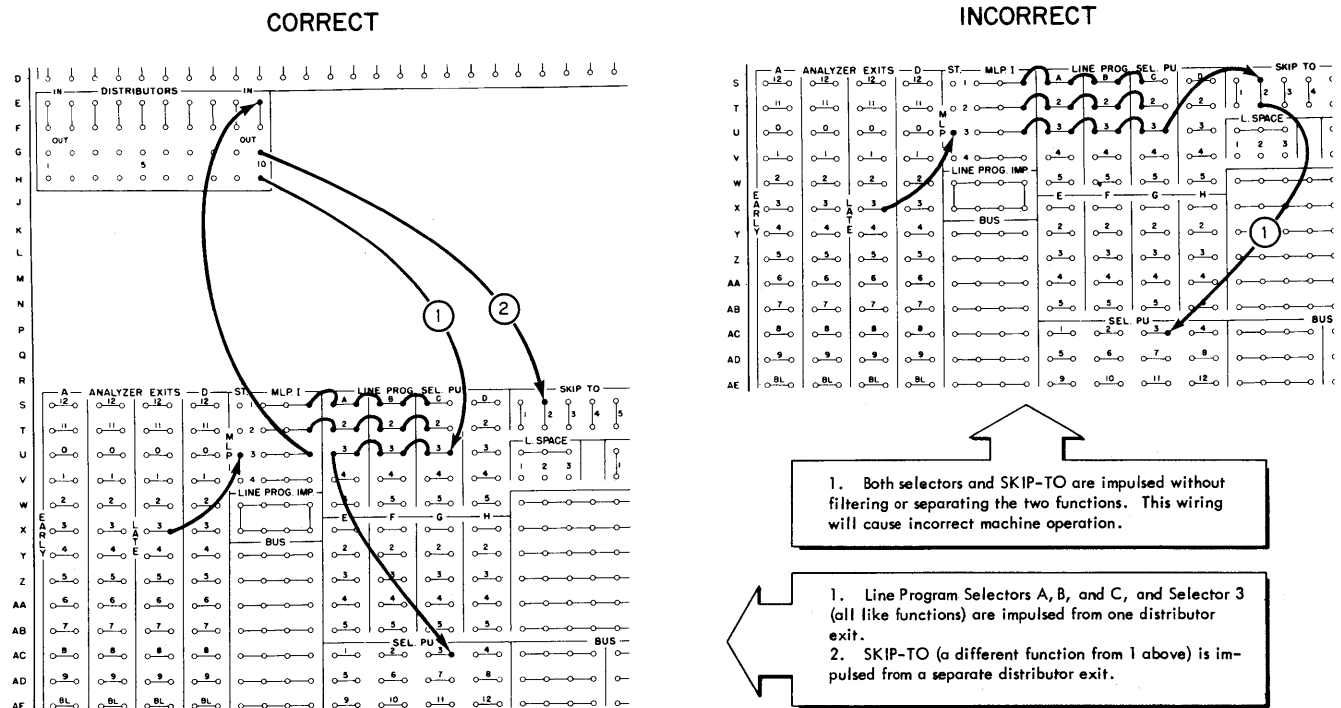

Figure 114. Correct Method of Impulsing Dissimilar Functions

CLEAR, COLUMN CONTROL ON, PROGRAM ON, SELECTORS, etc., are all dissimilar functions. On the 305 Process Control Panel, PRINT, PUNCH, and TYPE are all different functions.

Figure 114 (which shows a portion of the wiring for an MLP operation) illustrates correct and incorrect methods for impulsing Line Program Selectors, Selectors, and SKIP-TO.

Other Wiring Rules

1. Two or more successive impulses should not be directed to the PRINT hub on the process control panel without an intervening transfer to the output track. If a second impulse is directed to PRINT before the first line has completed printing, the second line will not print, and skipping difficulties may occur.

2. The EXIT of one distributor must not be wired to the ENTRY of another distributor (i.e., distributors cannot be wired in series).

3. The OUT hub of CYCLE DELAY, RECORD ADVANCE, and SKIP TO RECORD emits a regenerated impulse and may be filtered. The impulse from the Inquiry OUT hub is a regenerated impulse *only* if an inquiry has just been processed. Therefore, for wiring purposes, the inquiry hubs must be treated in the same manner as an accumulator selector (i.e., assume the original impulse directed to the Inquiry IN hub will be the same impulse available at the Inquiry OUT hub).

Load Rating

All control panel exits and distributors are designed to withstand a specific amount of electrical load which,

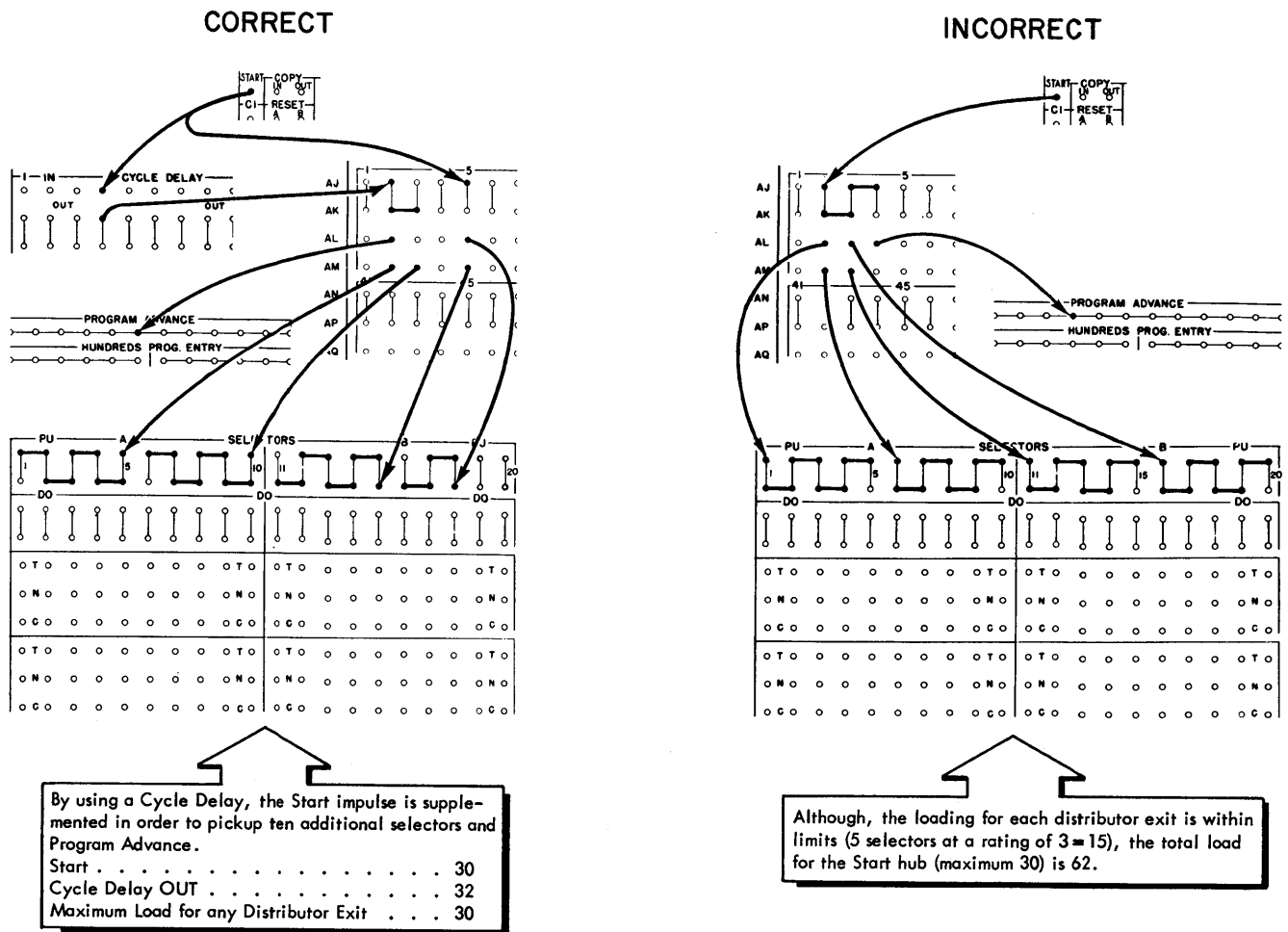

Figure 115. Wiring Based Upon Load Chart Ratings

if exceeded, may cause damage and improper operation of the machine. Therefore, when a control panel exit or distributor exit is wired to more than one control panel function, it must be determined that the electrical load is within established limits.

All control panel exits may be loaded to a maximum rating of 60 with the following exceptions:

- (1) 305 — Distributors — 30 max.
 — Inquiry Out — 30 max.
 — Start — 30 max.
- (2) 370 — Distributors — 30 max.
 — MLP I Exit — 30 max.
- (3) 380 — Distributors — 30 max.

To insure that electrical limits are not being exceeded, reference can be made to the Load Rating Table shown

in Figure 116. Add the individual load ratings for each function associated with an exit to be sure the maximum allowable load is not exceeded. Also, be sure that each distributor exit is not overloaded. Figure 115 illustrates both correct and incorrect wiring.

Use of Control Panel Distributors

Because of the need for many distributors when dealing with complex wiring problems, methods of conserving distributors are often necessary. The following section demonstrates some of the principles involved in using logic selectors to save distributors. In addition, examples show how rearrangement of control panel wiring can save additional distributors.

CONTROL PANEL	LOAD	CONTROL PANEL	LOAD	CONTROL PANEL	LOAD
ENTRY HUB	RATING	ENTRY HUB	RATING	ENTRY HUB	RATING
— 305 —		— 370 —		— 380 —	
Accumulator Drop Out	3	Comm Channels	0+	Carriage Return	2
Accumulator Overflow IN	0+	Co-selector PU	2	Clear	2
Accumulator Sign IN	0+	Distributors	0+	Col Ctrl. Entry	2
Blank Transmission IN	0+	Line End	8	Col Ctrl. Delay	2
Char Sel Alpha IN	0+	Line Prog Sel PU	3	Col Ctrl. On	2
Char Sel Numeric IN	0+	Line Space	8	Column Split	4
Comm Channel (Print)	0+	MLP Start 1	2	Comm Channel	0+
Comm Channel (Punch)	0+	MLP Start 2	3	Digit Selector PU	2
Compare IN	0+	MLP Start 3	4	Distributors	0+
Cycle Delay	6	MLP Start 4	6	Program Entry	2
Distributors	0+	Output Track	1	Program On	2
Feed Card	3	Print Space	1	Ribbon Shift B	2
Field Compare IN	0+	Print Start	2	Ribbon Shift R	2
Hundreds Program Entry	1	Print Stop	12	Selector PU	3
Inquire IN	5	Skip to Hubs	3	Selector DO	3
Last Card IN	0+			Space	8
Print	5			Tab	2
Program Advance	2			Type 100	2
Punch	3			Type only	4
Record Advance IN	5			Zero Suppress Off	2
Reset	3			Zero Suppress On	3
Reset Stop	3				
Selector PU	3				
Selector DO	3				
Skip-To-Record	6				
Stop	1				
Tens Program Entry	1				
Type	5				
Units Program Entry	2				
— 323 —					
BC Det. Control	2				

NOTE:

When a load rating of 0+ is shown, the load is determined by the final use of the function. For example, assume a panel impulse is wired to accumulator overflow IN, overflow NO is wired to Program Advance, and YES is wired to type and Units and Tens Entry. The load rating for the NO condition is 0 + 2 = 2. For YES, 0 + 5 + 2 + 1 = 8.

Figure 116. Load Chart

EXAMPLE 1:

CONTROL EXIT "A" TESTS ACCUMULATOR 1

- + PU Sel's. 2 and 3
Skip to Program 56
- 0 DO Sel's 7 and 8
Skip to Program 92
- Skip to Program 73

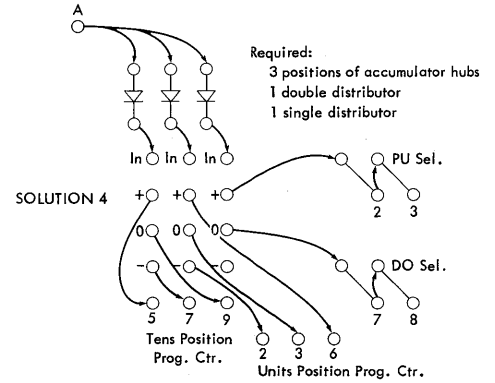
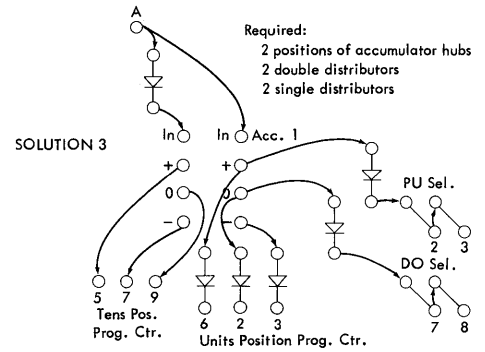
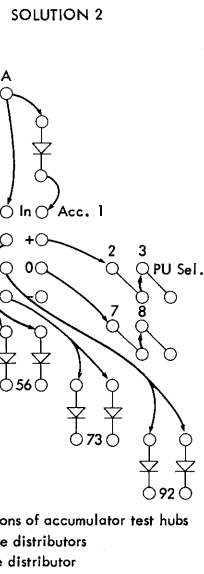
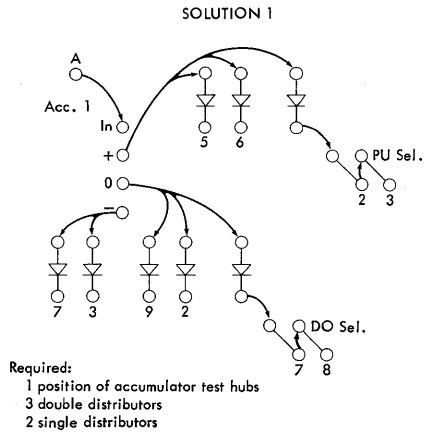

Figure 117. Part I

EXAMPLE 2:

CONTROL EXIT -- A

- TEST ACC. 2
A +or 0 Test Acc. 5
- Test Selector 2
- TEST ACC. 5
+ Step 92
0 Step 97
- Test Selector 3
- TEST SELECTOR 2
N Step 83
T Step 57
- TEST SELECTOR 3
N 51
T 90

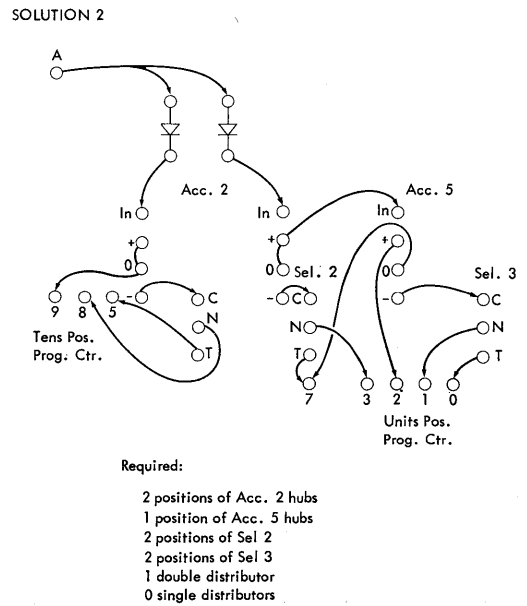
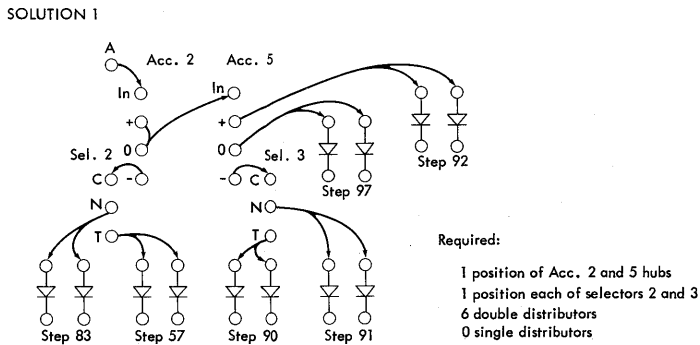

Figure 117. Part II

EXAMPLE 3:
CONTROL EXITS B AND C

B
Test Compare
= Program Advance
≠ Step 92

C
Test Blank Trans.
No Step 57
Yes Step 92

SOLUTION 1

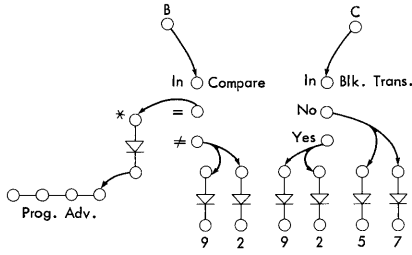

Required:
1 pos. of compare selector
1 pos. of blank trans.
3 double distributors
1 single distributor
* serves no useful purpose

SOLUTION 2

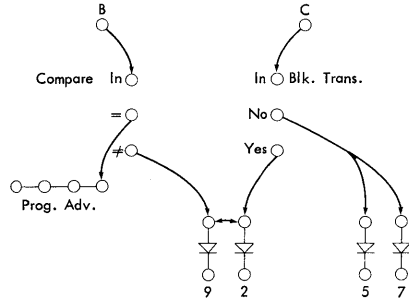

Required:
1 pos. of compare selector
1 pos. of blank trans. selector
2 double distributors
0 single distributors

Figure 117. Part III

EXAMPLE 4:

CONTROL EXIT D and E

D
TEST ACC. 2
+ Program 32
0 Program 52
- Program 72

E
PICK UP SELECTORS 5 - 8
TEST ACC. 2
+ Program 32
0 Program 52
- Program 72

SOLUTION 2

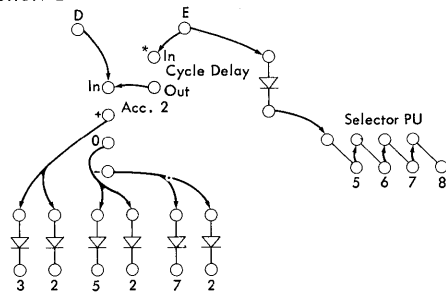

Required:
1 position of Acc. 2
3 double distributors
1 single distributor
1 cycle delay

*A distributor is not required on the entry of the cycle delay because the cycle delay circuits are filtered internally.

SOLUTION 1

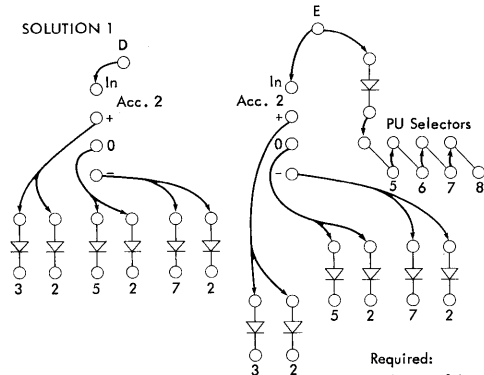

Required:
2 pos. of Acc. 2
6 double distributors
1 single distributor

SOLUTION 3

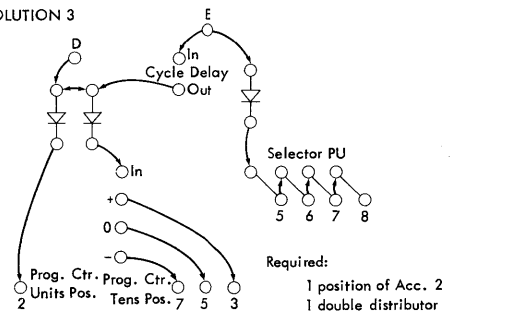

Required:
1 position of Acc. 2
1 double distributor
1 single distributor
1 cycle delay

Figure 117. Part IV

WIRING AND PROGRAMMING SUGGESTIONS

THE FOLLOWING wiring and programming suggestions may be used as an aid by the programmer.

Program Exit Expansion

Lengthy or complicated programs may require more than 47 program exits to complete the routine. The most common method of expanding program exits to gain additional capacity is by wiring through the normal and transferred points of selectors.

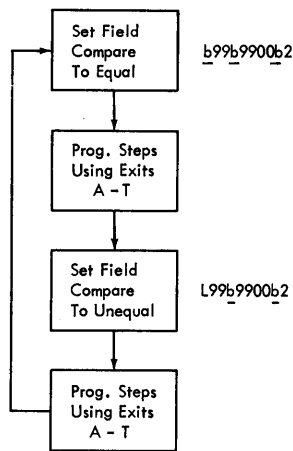

Figure 118.

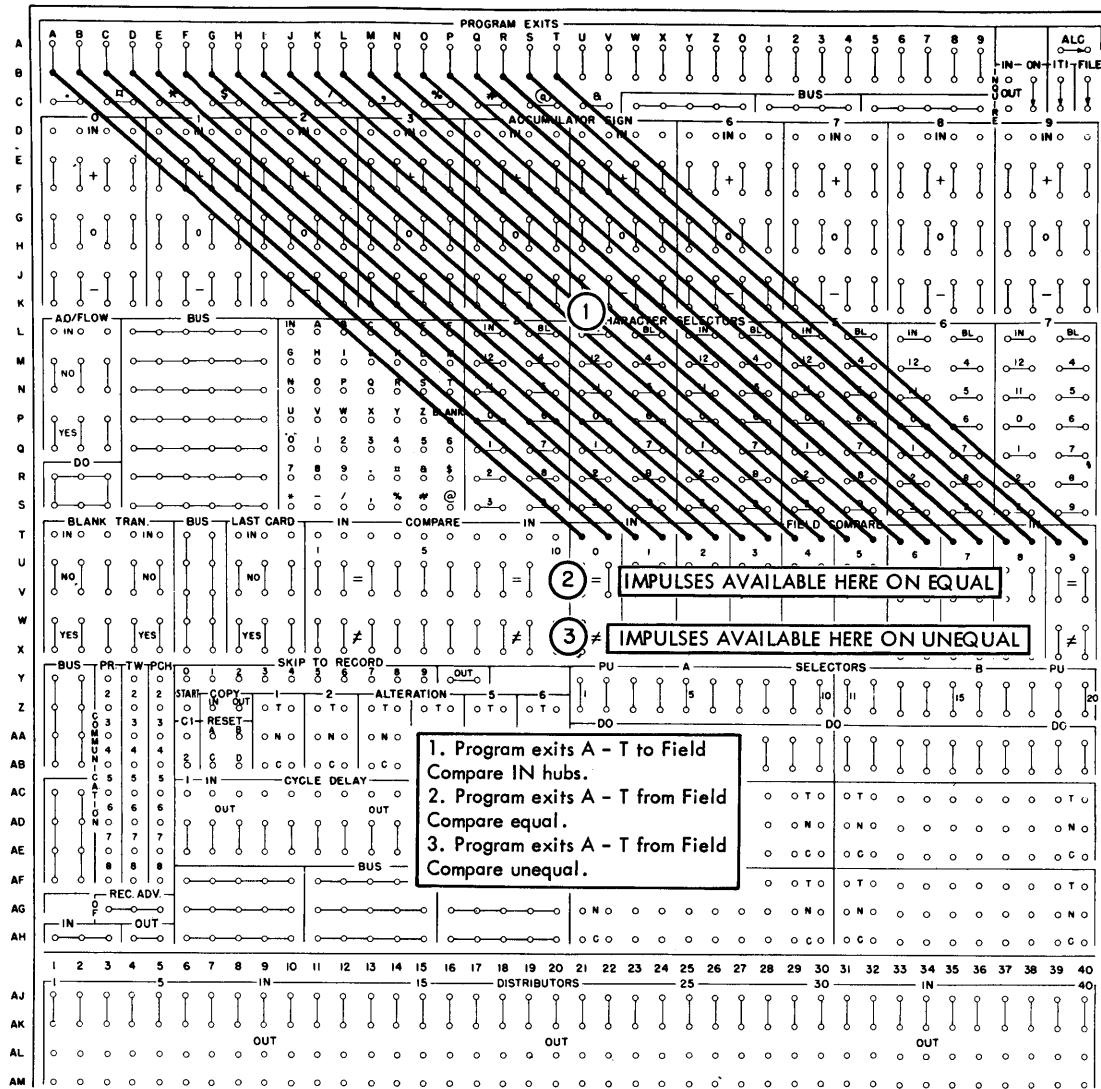

Figure 119. Program Exit Expansion-Field Compare Selectors

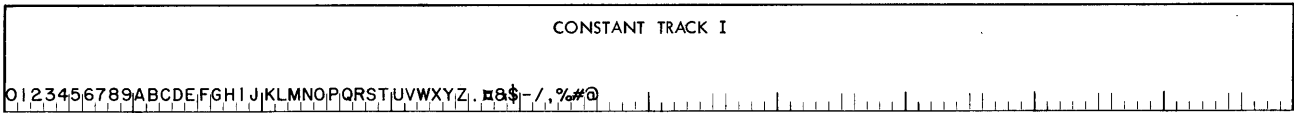

Figure 120. Constant Track

METHOD 1

Program exits may also be expanded by using the Field Compare hubs on the process control panel (Figure 119) and by programming techniques similar to those shown in Figure 118. The method illustrated is practical only if the Field Compare hubs are not used in the program for a field compare operation, and not more than 20 additional program exits are required.

METHOD 2

An alternate method of expanding program exits is by using a character selector. This method requires a constant track (Figure 120) and an instruction each time the exit is used. The instruction transfers the desired constant to the character selector, and the program exit which becomes available at the corresponding character selector exit is used for testing control panel functions.

An instruction such as I00-9901A would transfer the constant "0" from track I to the character selector and program exit A (Figure 121) becomes available at the "0" hub of the character selector. This impulse is used in the same manner as a program exit impulse.

Communication Channel Wiring

To insure that the correct combination of control panels is being used in RAMAC, communication hubs may be used in conjunction with the start impulse to test (Figure 122). If any other than the correct combination is present, the program will not be started.

Asterisk Protection

Asterisk protection for the printer can be accomplished through programming by assembling asterisks on the output record for all left hand zeros. A test is then made of each left hand position and zeros are re-

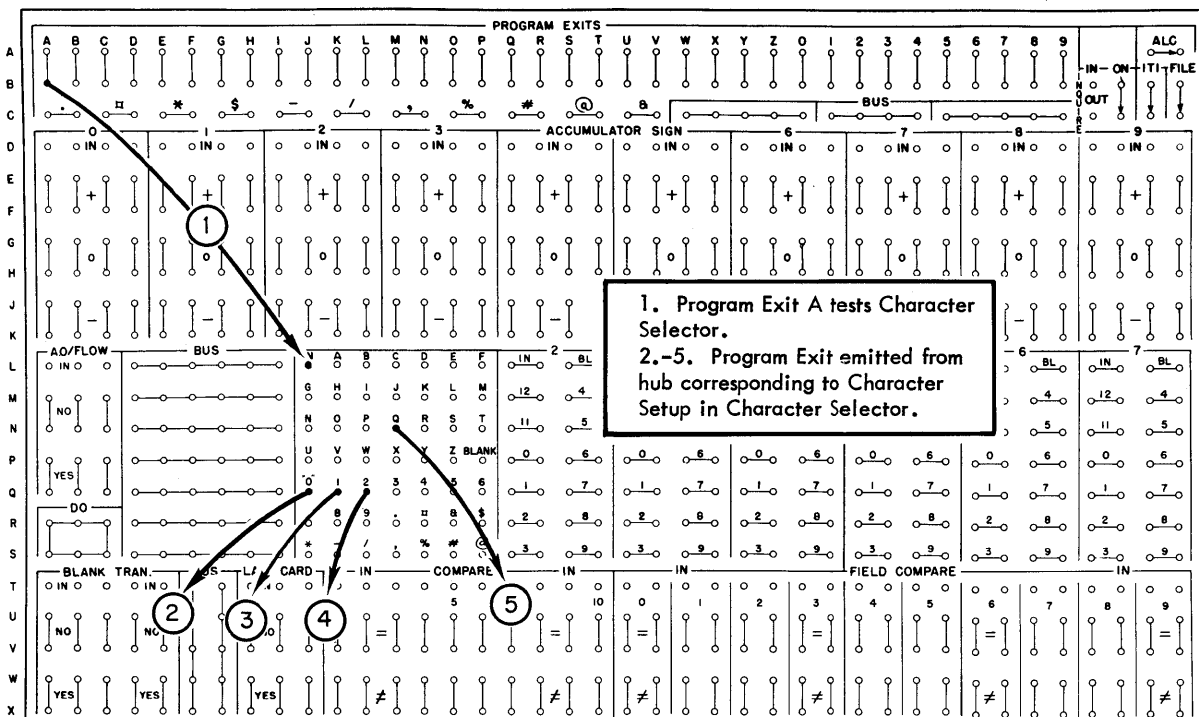
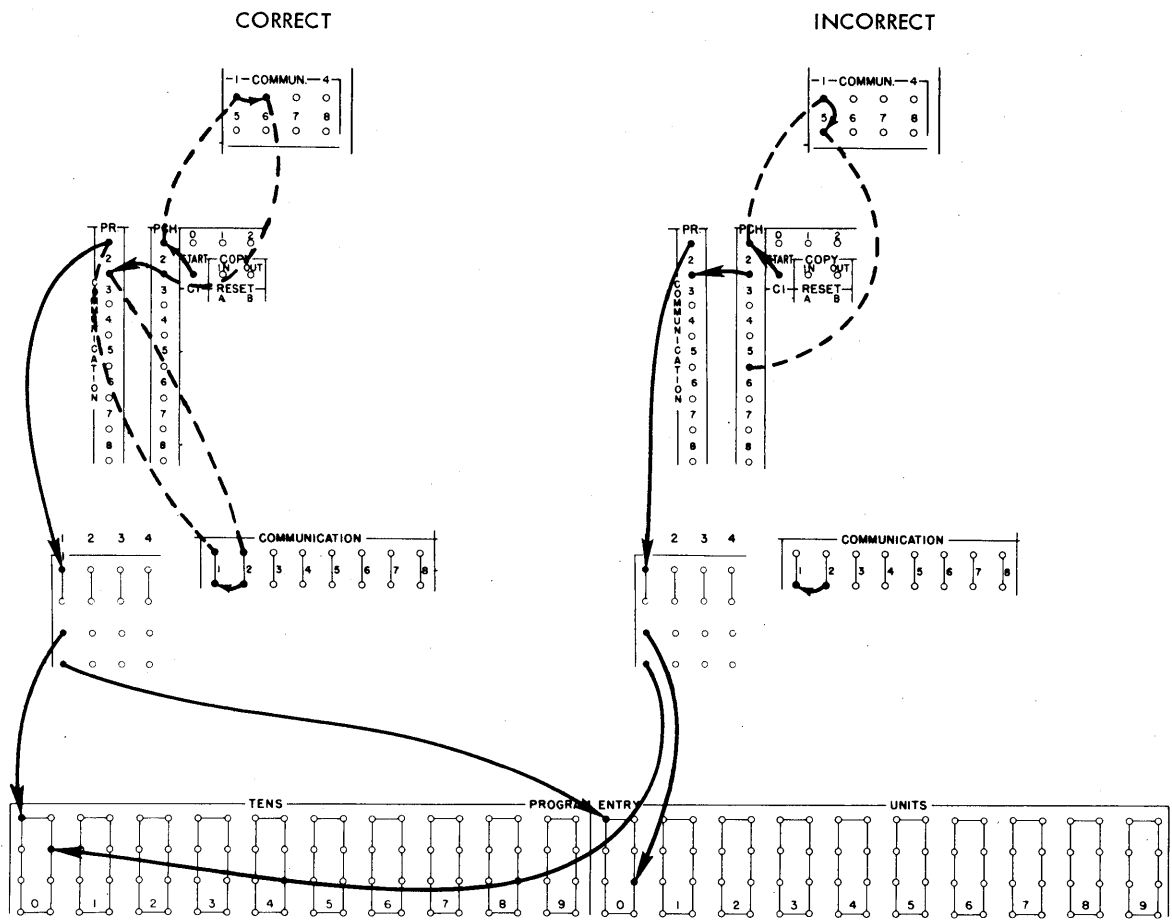

Figure 121. Program Exit Expansion-Character Selector



Correct combinations of panels directs start impulse to Program Entry 00.

Incorrect punch panel breaks circuit from Start to Program Entry 00.

Figure 122. Communication Channel Wiring

placed by asterisks until the first position which has other than zero is detected. The principle involved is shown in Figure 123. The wiring for asterisk protection is shown in Figure 124.

Wiring (Figure 124)

Up to four positions of asterisk protection can be provided by control panel wiring. Figure 124 shows the wiring for two positions. Output track positions 60 and 61 are to print in positions 15 and 16, and if either or both should be a zero on the output track, an asterisk will print in that position.

1. Output track positions 60 and 61 are tested for zero.
2. If a zero is present on output position 60, selector 6 is transferred from the A analyzer 0 exit.

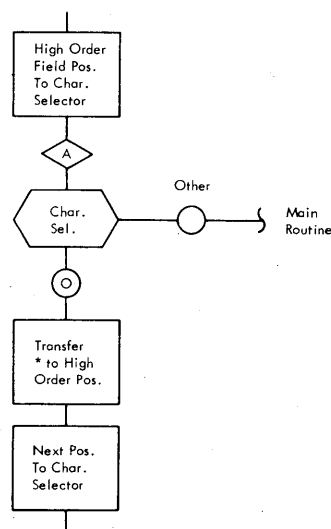

Figure 123.

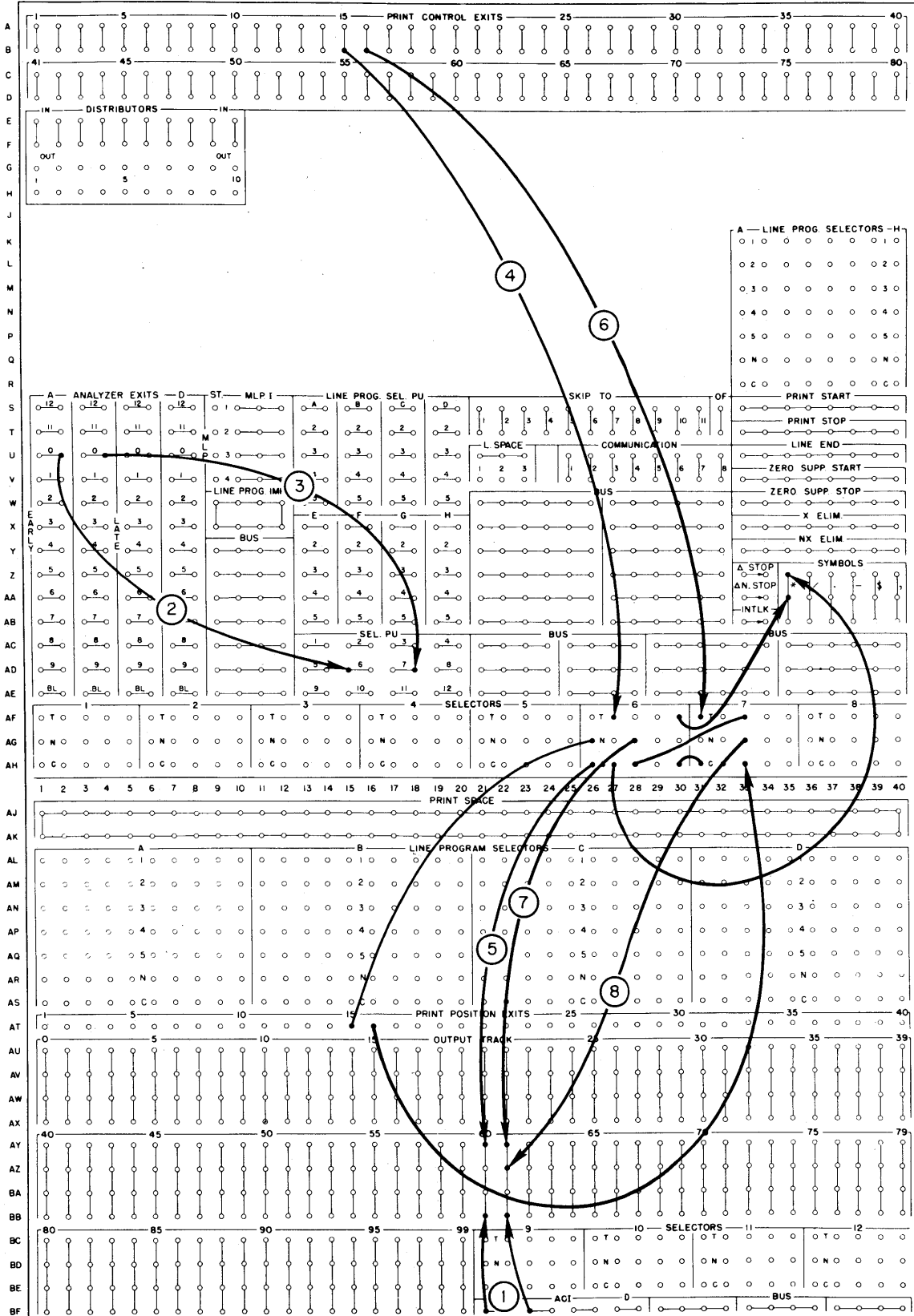

Figure 124. Asterisk Protection

3. If a zero is present on output position 61, selector 7 is transferred.

4. If selector 6 is transferred (zero), an asterisk prints in position 15.

5. If selector 6 is not transferred (non-zero), the character on the output track prints in position 15.

6. If both selectors 6 and 7 are transferred (zero in both positions), an asterisk is printed in positions 15 and 16.

7. If selector 7 is transferred but selector 6 is normal (zero with significant character to the left), the output track character is printed in position 16.

8. If selector 7 is normal, the output track position is printed in position 16.

NOTE: Two more positions may be tested by using similar wiring on analyzers C and D.

OPERATING HINTS

THE FOLLOWING operating hints may be used as an aid by the operator.

Common Operating Errors

Condition: ACCESS UNIT INTERLOCKED.

Common Cause: Test lock left on.

Condition: TYPEWRITER LOCKED WHEN INVESTIGATING PARITY ERROR OR READING TRACK TO Q.

Common Cause: Control Selector set on Single Cycle rather than Run. (Turn to Run, depress Program Start.)

Condition: MANUAL TYPING NOT POSSIBLE.

Common Cause: Machine is processing and control panel is wired to prohibit manual typing (ITI on).

Condition: FAILURE TO GET INQUIRY LIGHT AFTER DEPRESSING FORMAT KEY (WHEN NOT PROCESSING).

Common Cause: Machine not in reset condition or test lock on.

Condition: PRINT INTERLOCK ON FIRST ITEM PRINTED.

Common Cause: Failure to ready printer by depressing Print Start key.

Condition: CONTROL STOP LIGHT ON.

Common Cause: Always on when control selector switch is on. Single Operation or Single Cycle — normal condition.

Condition: TYPEWRITER TYPES IMMEDIATELY AFTER DEPRESSING WRITE.

Common Cause: With Test Lock OFF, depressing Write always returns data on Q to track from which it originated.

Condition: SPECIAL CHARACTERS TYPE AS NUMBER (#) ON THE 380.

Common Cause: It is normal for the %, @, □, and comma to type as # on the 380; program should be planned to utilize other symbols in areas where it is necessary to differentiate between these characters when typing.

DIGIT	ZONES		CHAR.
	X	0	
NO DIGIT	●	—	&
	●	●	O
1	●	●	A
	●	●	J
		●	/
			1
2	●	●	B
	●		K
		●	S
			2
3	●	●	C
	●		L
		●	T
			3
4	●	●	D
	●		M
		●	U
			4
5	●	●	E
	●		N
		●	V
			5
6	●	●	F
	●		O
		●	W
			6
7	●	●	G
	●		P
		●	X
			7
8	●	●	H
	●		Q
		●	Y
			8
9	●	●	I
	●		R
		●	Z
			9
11	●	●	.
	●		\$
		●	,
			#
12	●	●	π
	●		=
		●	%
			@
	X	0	

CONSOLE READING AID

The Console Reading Aid (Figure 125) is designed to help the operator decipher the binary coded instruction lights more quickly and easily. It should be used in the following manner:

1. Mentally arrive at the sum of the numeric lights glowing. For example:

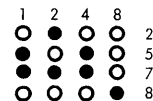

2. Refer to the chart for the digit which corresponds to this sum. (left hand column)
3. Find the proper zone lights opposite this digit.
4. Follow across to the number, letter, or special character represented by these lights.

In the following example; the X, 0, 2, and 4 lights are glowing:

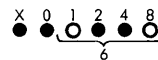

Because the numeric lights total 6, the zone lights opposite the digit 6 on the chart should be checked for a matching condition. The matching zone pattern (an X and 0 in this example) should then be followed across to the character represented, which in this case is the letter F.

Figure 125. Console Reading Aid Chart

Special Features

THIS SECTION describes the operation of Special Features which may be added to the IBM 305 RAMAC.

323 PUNCH

SPECIAL FEATURES for the 323 Punch are presented in this section.

Co-selectors

As a special feature, up to five groups of four 5-position Co-selectors may be installed to allow changes in punching format for different types of cards. Each selector is a five-position selector with two common pickup hubs. Each position has a C (common), N (normal), and a T (transferred) hub. The common hub is connected to the normal hub until the selector is picked up by impulsing the pickup hub. Then the common is connected to the transferred hub.

When the pickup is impulsed, the selector transfers immediately, and will remain transferred for the remainder of the punch cycle.

The Co-selector pickup hubs may be impulsed from any digit impulse, Half-After-Zero, (0.5), Pilot Selector COUPLE, or from the Punch Repeat OUT hubs; however, they should not be impulsed by a 305 Program Exit wired through a Communication Channel. Co-selectors must be used if it is necessary to select BC DET CONTROL wiring when controlling DPBC checking for different card formats, as well as the DPBC STOP, OFFSET, and BC OFF switches.

Pilot Selectors

Two groups of five 2-position Pilot Selectors may be installed as a special feature. Each selector has a P. EXIT

(program exit) pickup, DEL (delay) pickup, and a COUPLE (exit only). There are two positions associated with each selector. Each position has a C (common), N (normal), and a T (transferred) hub.

If a Program Exit is wired through a Communication Channel for the purpose of impulsing a Pilot Selector, the Program Exit must be wired to the P. EXIT pickup. Improper operation will result if a Program Exit is wired to any other selector pickup. When the P. EXIT pickup is impulsed, the selector will transfer immediately, and will remain transferred for the duration of the associated punch cycle. *The Program Exit that is wired to the P. EXIT pickup must be the same Program Exit that is wired to PUNCH on the Process Control Panel.*

It is possible to impulse the P. EXIT pickup from a digit impulse; however, if an output error should occur, the selector will remain transferred throughout a run-out and run-in procedure. On a run-out and run-in procedure (as explained under *Error Correction Procedures*) the last punched card is repunched on the run-in, and because the selector would be transferred during the repunching of the last punched card, operations such as split column control would not function properly.

The DEL (delay) pickup may be wired from any digit impulse, COUPLE, or from the Punch Repeat OUT hub. It cannot be impulsed by a Program Exit wired through a Communication Channel. When the DEL pickup is impulsed, the selector will transfer one punch cycle later, and will remain transferred for one cycle. In the event of an output error, selector control will be automatically maintained. For example, if an error occurs during the Pilot Selector setup cycle, it will be set up again if it is necessary to run the cards out of the machine and back in again. If an error occurs after the Pilot Selector has transferred, it will remain transferred throughout a run-out and run-in.

Associated with each Pilot Selector is a COUPLE hub. If a Pilot Selector is transferred by impulsing the P. EXIT pickup from a Program Exit, the COUPLE hub will emit just prior to punching time for that card. If a selector is picked up by impulsing the DEL (delay) pickup, the COUPLE exit will emit one cycle later just prior to punching time.

If it is desirable to expand the number of available positions of a Pilot Selector, the COUPLE exit may be wired to a Co-selector pickup. The Co-selector will then function in the exact manner as the Pilot Selector. COUPLE may also be wired to the DEL pickup of another Pilot Selector to cause it to transfer one cycle later.

Wiring (Figure 126)

Figure 126 illustrates punching two cards from a

single output track.

1. Punch Repeat IN (P) is impulsed through a Communication Channel with the same program exit that is wired to Punch on the process control panel.

2. During the first punch cycle, positions 90-99 of the output track are directed through the normal side of Co-selectors 1 and 2 to the Punch Magnets.

3. Punch Repeat OUT emits just before punching time of the second card. Co-selectors 1 and 2 are picked up.

4. Positions 45-54 of the output track are directed through the transferred side of the selectors to punch.

5. The first ten positions of DPBC are wired.

6. The last DPBC position being checked is wired to the last Blank Column Detection Control position (position 20, standard machine), and the punch is wired to stop in the event of a DPBC error.

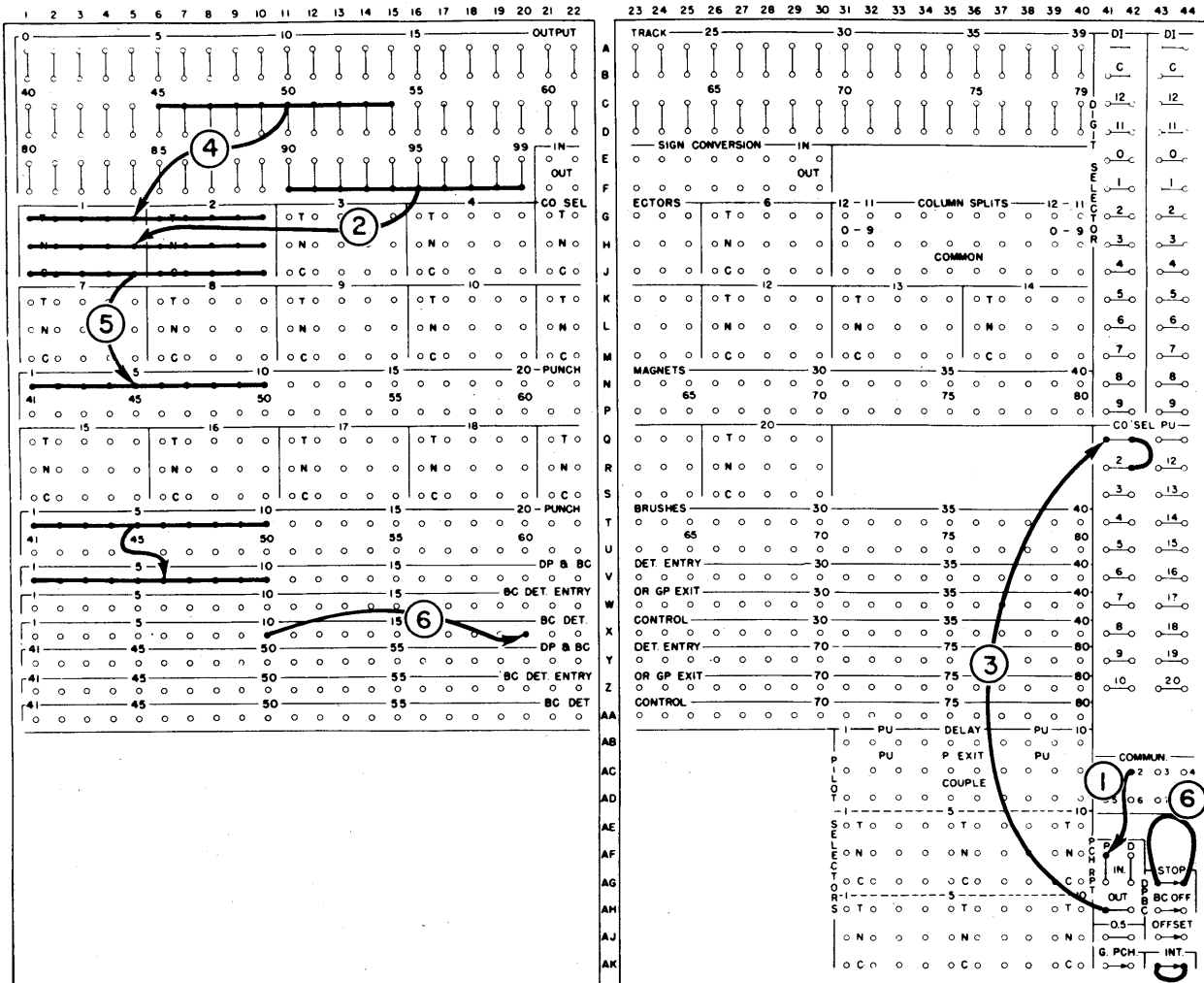

Figure 126. Punch Repeat — Punching two different output track fields into one field of two different cards

Wiring (Figure 127)

Punch Repeat is used in Figure 127 for punching the same information (positions 45-47) into columns 1-3 of the first card and into columns 10-12 of the second card. DPBC is included.

1. Punch Repeat IN (P) is impulsed through a Communication Channel.
2. Output track positions 45-47 are punched in columns 1-3 on the first punch cycle. Co-selector 1 is normal.
3. Co-selector 1 is picked up for the punch repeat cycle, and Pilot Selector 3 (DEL pickup) is impulsed. Pilot Selector 3 will transfer one cycle after the repeat cycle.

4. Output track positions 45-47 are punched in columns 10-12 on the repeat cycle. Co-selector 1 is transferred.

5. Pilot Selector 3 COUPLE exit is wired to pickup Co-selector 4. Co-selector 4 is always transferred one cycle after Co-selector 1 so that DPBC checking can be controlled from the punch brush station.

6. DPBC Detection Entry (1-3) is wired through Co-selector 4 so that positions 1-3 will be checked for the first card and positions 10-12 will be checked for the card that was punched during the repeat cycle.

7. The last DPBC position being checked is wired to the last Blank Column Detection Control Position (position 20, standard machine), and the punch is wired to stop in the event of a DPBC error.

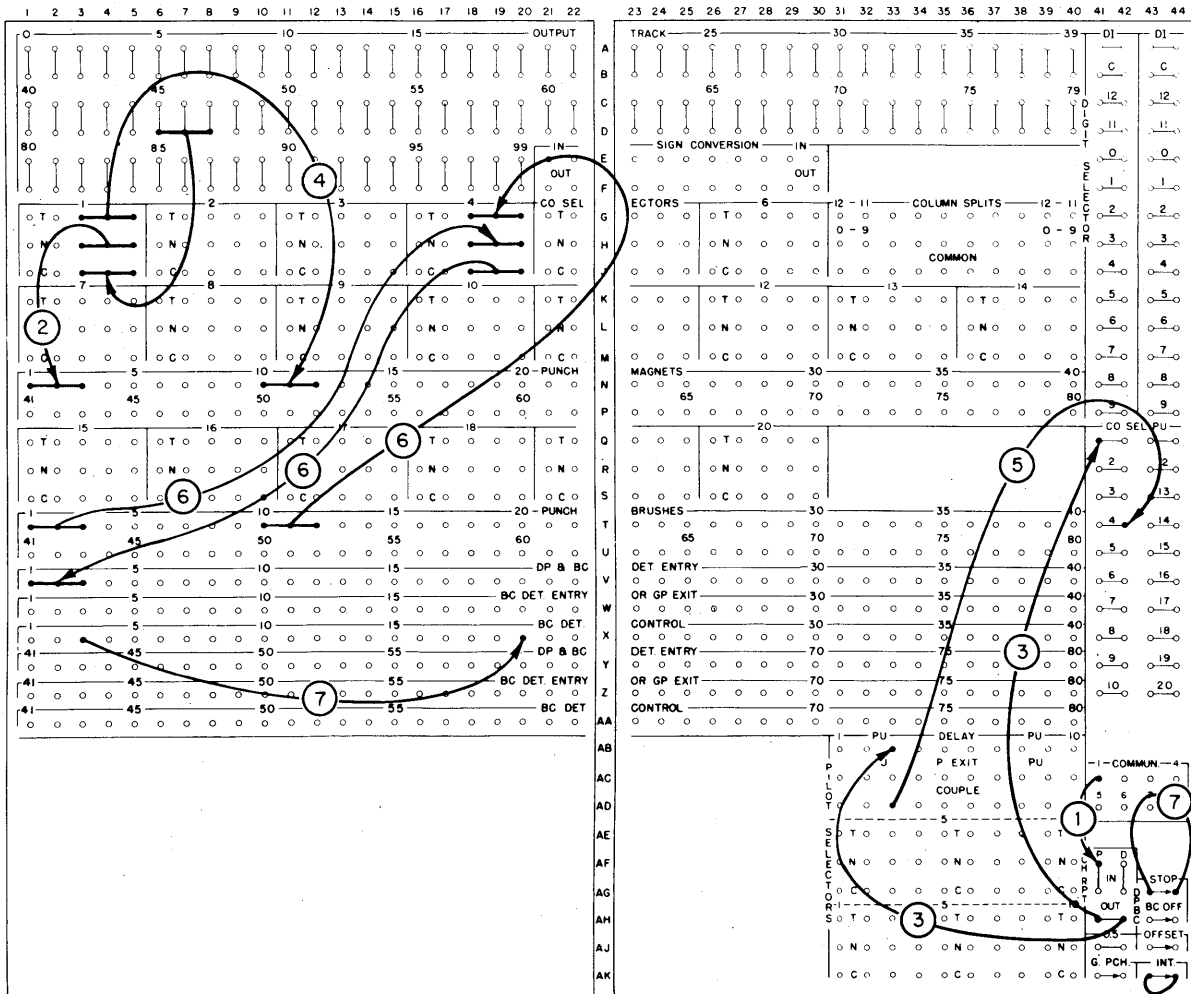

Figure 127. Punch Repeat — Punching the same information into two different fields in two different cards

Offset Stacking Feature

When the Offset Stacking Feature is installed, the DPBC Offset switch may be plugged to offset an error card rather than stop. It is also possible to offset different types of cards so that they may be easily distinguished from the main group of cards when removed from the stacker. This switch may be selected; however, Co-selectors must be used.

Wiring (Figure 128)

Figure 128 illustrates offsetting different types of cards. In this example all cards containing either a 2 or 5 are offset.

1. Column 75 of the card contains the offset code and is wired to the Digit Selector COMMON.
2. Digit Selector exits 2 and 5 are wired to the right side of the Offset switch to cause offsetting.

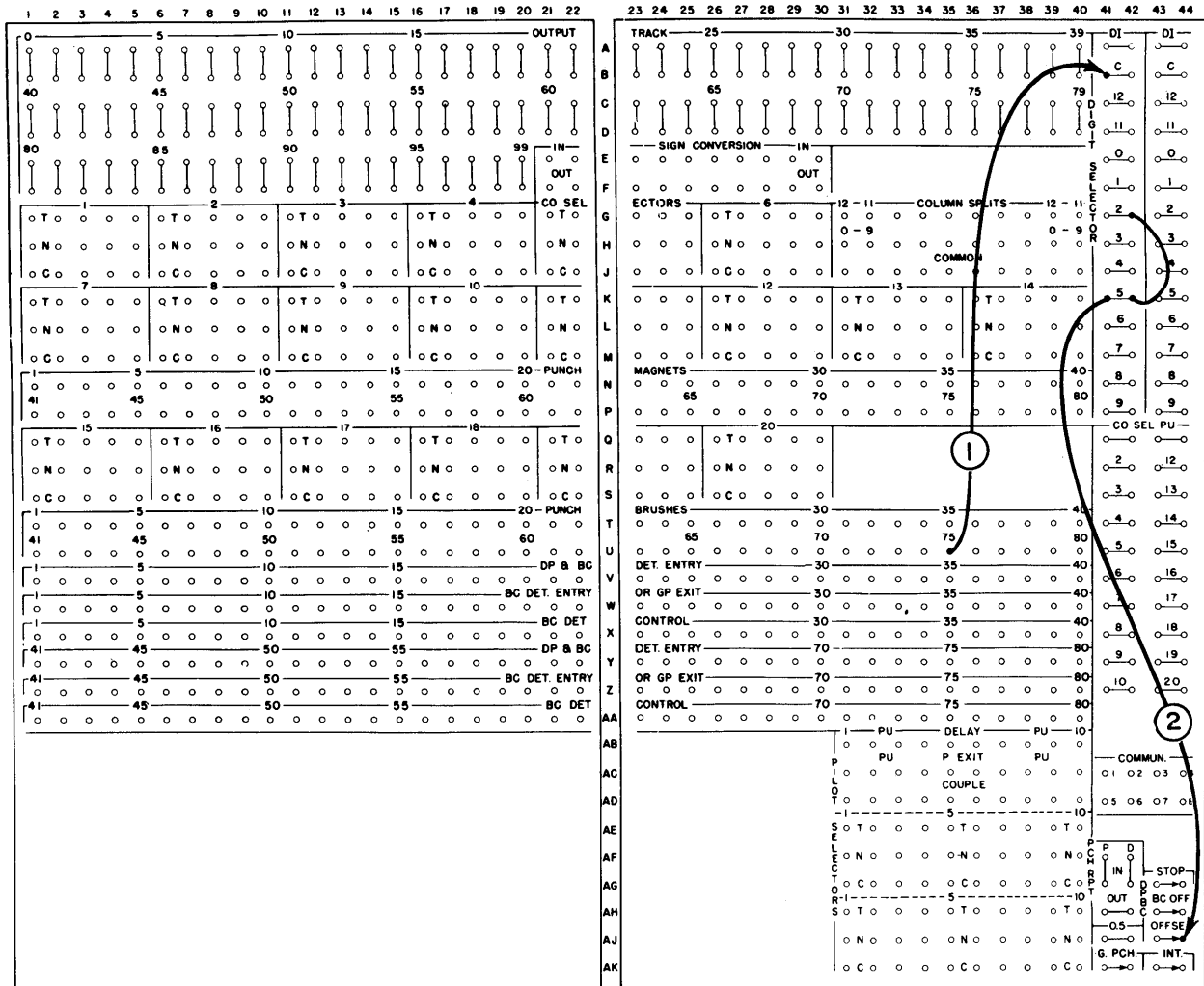

Figure 128. Off-setting Different Types of Cards

PRINTER OUTPUT TRACK

A PRINTER OUTPUT TRACK, track T, is available as a Special Feature. When this feature is installed, the S track is assigned solely to the 323 Punch, and the T track becomes the output track for the 370 Printer. With this second output track, completely independent operation of the punch and printer is obtained.

During processing, the S and T tracks must be loaded individually, but printing and punching may occur simultaneously. As soon as punching of the first card for an item is complete, additional information may be transferred to the S track without interlocking even though a print operation may still be in progress.

Without the Printer Output Track, printing and punching of completely different data can be accomplished; however, the operations must occur sequentially with no overlapping possible. With the two output tracks, S and T, printing and punching can be performed simultaneously (see Figure 129).

305 PROCESS UNIT

THE FOLLOWING Special Features are available for the 305 Process Unit.

Processing Drum Tracks

Four additional processing drum tracks are available in two groups. The first group is addressed as U,

punched 0-4, and diagonal (/), punched 0-1. The second group is addressed as period (.), punched 12-3-8, and pound sign (#), punched 3-8. These four additional drum tracks function in the same manner as the standard working storage tracks (W, X, Y, and Z).

Program Exit Split

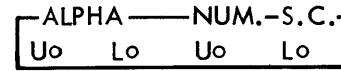

C, 23-26

As a Special Feature, the double Program Exit hubs can be split and placed under selector control, so that either the upper hub or the lower hub, (but not both), will emit the corresponding program exit impulses. The common connection between each pair of alphabetic, numerical, and special character Program Exit hubs on the standard control panel is removed.

This feature is divided into two groups; Program Exit hubs A-Z make up the first group, and Program Exit hubs 0 (zero) through 9 and special characters make up the second. In the case of the special character hubs, the left hand hub is considered the upper.

The operation of this device consists of impulsing either the U (upper) or L (lower) pickup hubs (located

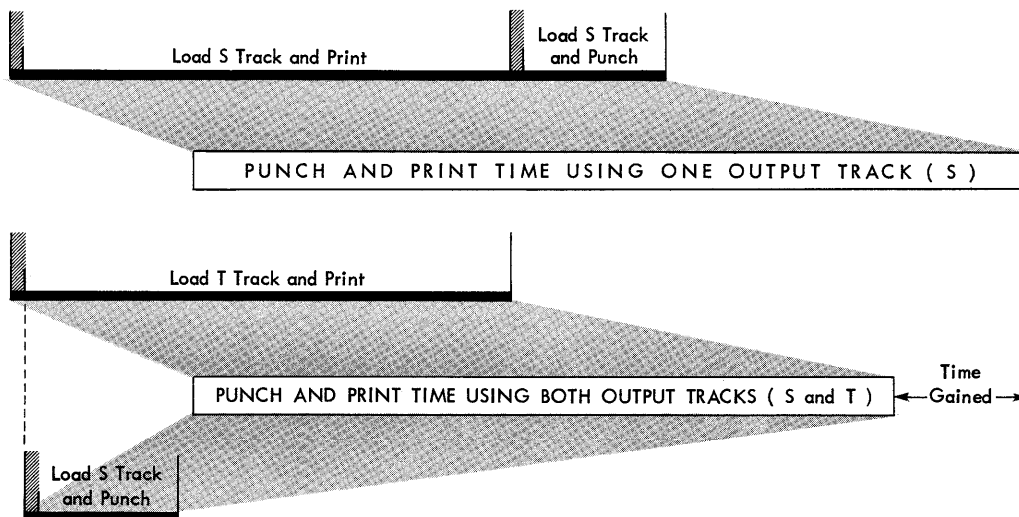

Note : ▨ = Instruction Time

Figure 129. Punch and Print Time — Different Data

in control panel positions C, 23-26, with a Program Exit, Start, Cycle Delay, or Control Impulse, etc. If the upper hub is impulsed, the corresponding Program Exit hub of this group will emit until the lower hub is impulsed. If the lower hub is impulsed, the lower row will emit until the upper hub is again impulsed. When a pickup hub is impulsed, the Program Exit hubs will transfer just prior to the next Program Exit in the stored program routine.

At the beginning of a job, either a Start, Copy Out, or a Control Impulse should be used to setup the exits for the beginning of the job. Reset and Check Reset have no effect on the position of the exits.

305 Program Entry Isolation

Addition of this Special Feature permits wiring to Program Entry hubs without the necessity of using distributors. Each of the eight entry hubs for the hundreds, tens, units positions of program entry, and program advance hubs have individual distributors built in to prevent back circuits. In most cases it is only necessary to use a distributor in the wire that goes to a control panel function other than Program Entry. However, if it becomes necessary to use a distributor to prevent back circuits to some other function on the control panel, it is permissible to wire one distributor in series with the Program Entry hubs. The control panel arrangement and location of the hubs remains exactly the same, except that the hubs have the common connections removed.

X-no X and 0-no 0 Character Selector Positions

Three positions each of X-no X bit and 0-no 0 bit selection may be added to the function of the Character Selector. These logic features are located in control panel positions L-N, 4-9 as shown below:

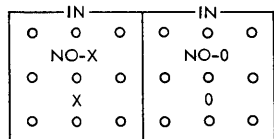

L-N, 4-9

They are activated by a TO address of -99 in the same manner as the present Character Selectors. These selectors allow analyzing of a character sent to the Character Selector for the presence or absence of X and 0 bits.

The zone component of an alphabetic character, or the presence or absence of a sign over a calculated field can be determined by these two selectors. Credit X's over a zero field would cause both selectors to transfer to their X and 0 side. In the case of an alphabetic character, 12 zones cause both selectors to transfer, X zones cause only the X bit selector to transfer, and 0 (zero) zones cause only the 0 bit selector to transfer.

Latch-Type Selectors

A fourth group of ten latch-type selectors (31-40, group D) are available. They are located in control panel positions BG-BR, 11-20 and are in line with group C selectors 21-30. A reset hub for the group D selectors is also provided at control panel location AB, 8.

The first ten selector lights on the 380 Console are used to indicate the status of group A, 1-10 and group D, 31-40. When the indication switch, (just to the left of the test lock, Figure 130) is in the lower position, the status of selectors 1-30 is displayed, and when the switch is in the upper position, lights 1-10 indicate the status of the additional (31-40) selectors. Two additional lights above the selector lights, (Figure 131), labeled 1-30 and 31-40, indicate which group of selectors is being displayed.

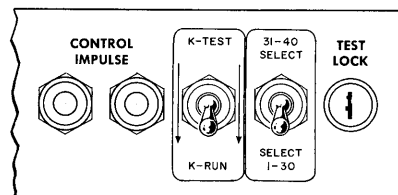

Figure 130.

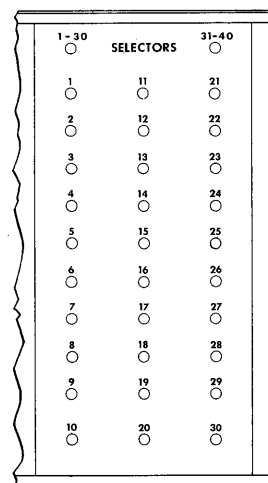

Figure 131.

Cycle Delays

Fifteen additional cycle delays, (16-30), are available to increase the capacity of the RAMAC. They are identical in function and control panel arrangement to the present 1-15 cycle delays. The additional 16-30 cycle delays are entirely independent of 1-15 insofar as binary coded operation is concerned.

DIVISION

AUTOMATIC DIVISION is available for the RAMAC as a Special Feature. This section describes the operation of automatic division.

Limits

When automatic division is installed, a dividend as large as 19 digits and a maximum divisor of 9 digits may be used. A quotient of up to 19 digits may be developed; however, the number of digits in the divisor plus the number of digits in the quotient must not exceed 20 digits. For example, a 14-digit quotient can be developed by a 6-digit divisor: $6 + 14 = 20$. However, a 15-digit quotient cannot be developed by a 6-digit divisor because the sum would be 21 digits (over 20).

Operation

To execute a divide operation, the dividend is positioned in accumulators 0 and 1. This is accomplished with a normal 30-millisecond instruction. The divisor is loaded on the multiplicand track. This step also requires 30 milliseconds. The third step initiates the actual divide operation. The FROM and TO fields of this special instruction must always read L09P99xx. *The number-of-characters field (positions 7 and 8 of the program instruction) should always be equal to two times the number of digits desired in the quotient.* At the completion of the divide operation, both the quotient and the remainder appear in accumulators 0 and 1.

Division is actually performed by a series of repeated subtractions from accumulator 0, and shifts in accumulators 0 and 1. Two 10-millisecond cycles are required to develop each quotient digit.

On the first cycle the divisor is read from the multiplicand track and subtracted from the contents of accumulator 0. A count is kept of the number of times this subtraction takes place before an overdraw occurs in accumulator 0.

This count, stored in a separate one-position quotient counter, becomes the quotient digit. If an overdraw oc-

curs, the divisor is added back to the contents of accumulator 0 restoring accumulator 0 to a positive figure.

During the second 10-millisecond cycle, two operations occur; the entire contents of accumulators 0 and 1 are shifted one position to the left, and the quotient digit just developed in the quotient counter is placed into position 19 of the accumulator track. These two cycles are repeated until the desired number of quotient digits have been developed.

At the completion of a divide operation, the units position of the quotient is always located in position 19 of the accumulator track. If the quotient is 11 digits or less, the units position of the remainder will be found in accumulator 0 in position 08. If the quotient is greater than 11 digits the units position of the remainder will be shifted left one additional position for each quotient digit over 11.

Sign Control

The sign of the quotient will always be plus. If either the divisor or the dividend carries a negative sign, RAMAC automatically compensates in order to arrive at a positive quotient. If sign control is necessary, it must be accomplished through programming by testing the divisor and dividend for sign.

Divisor and Dividend Positioning for Quotients of 11 Digits or Less

For most applications, quotients of 11 digits or less will be ample to fulfill the requirements of the problem. Consequently, Rule 1 which follows applies to the largest portion of division problems.

Because only one quotient digit can be developed at a time, it is important to position the dividend and divisor so that the first subtraction in accumulator 0 will result in a quotient digit no greater than 9. This can be accomplished if the dividend and divisor are always placed so that the following general rule holds:

RULE 1

Maximum Quotient of 11 Digits or Less: The number of digits in the dividend to be positioned in accumulator 0 should equal the maximum possible digits in the dividend minus the maximum possible digits in the quotient plus 1.

(Maximum dividend digits) - (Maximum quotient digits) + 1 = Number of high-order digits of dividend to be in accumulator 0.

The low-order position of the divisor would be positioned on the multiplicand track in position V99.

NOTE: Zeros added to the right of a dividend to obtain a maximum quotient should be considered as part of the maximum possible dividend.

Sample Problem No. 1: (Quotient, 11 digits or less)

The nine digits in position 71-79 of track W are to be divided by the four digits in positions 60-63 of track Z. A quotient of 8 digits is desired. Using Rule 1, the dividend (9 digits) minus the quotient (8 digits) plus one (1) is equal to two (2). The dividend is placed in the accumulators with two positions in accumulator 0 by the instruction:

W79L1609b5
Note: b=blank

The second step is to place the divisor on the multiplicand track, where it is automatically written in each of

the ten fields. The instruction is:

Z63V9904

The third step is to begin the actual division by giving the instruction L09P99xx and specifying the required number of cycles in the number-of-characters field. In this case, sixteen cycles are required to develop the eight-digit quotient.

L09P9916

The results of these three steps are shown in Figure 132 using actual numbers:

Half-Adjust

If it is desired to half-adjust the quotient, the half-adjustment must always take place after the divide operation is completed. It will be necessary to develop one

$$672376413 \div 0062$$

Instruction	Operation	Accumulator 0	Accumulator 1	Quotient Counter	Time in Milliseconds
W79L1609b5	Reset accumulators & load 9-digit dividend	000000067	2376413000		30
Z63V9904	Place 4-digit divisor on V track	bbbbbbb62			30
L09P9916	Subtract	000000005	2376413000	1	30
	Shift and add 1	000000052	3764130001		10
	Subtract	000000052	3764130001	0	10
	Shift and add 0	000000523	7641300010		10
	Subtract	000000027	7641300010	8	10
	Shift and add 8	000000277	6413000108		10
	Subtract	000000029	6413000108	4	10
	Shift and add 4	000000296	4130001084		10
	Subtract	000000048	4130001084	4	10
	Shift and add 4	000000484	1300010844		10
	Subtract	000000050	1300010844	7	10
	Shift and add 7	000000501	3000108447		10
	Subtract	000000005	3000108447	8	10
	Shift and add 8	000000053	0001084478		10
	Subtract	000000053	0001084478	0	10
	Shift and add 0	000000530	0010844780		10

Total: 240 Milliseconds

The Quotient in positions 12-19 is 10844780, and the Remainder is 53.

Figure 132. Division Example No. 1

additional quotient position for half-adjustment; therefore, the number of digits in the dividend must be increased by 1, and 2 must be added to the number-of-characters field of the L09P99xx instruction so that one additional quotient digit will be developed. After the division is completed, a 5 must be added to position 19 of the accumulator track. If a quotient of over 10 digits is being developed, there is a possibility of an overflow into accumulator 0 and the 5 is added; the overflow selector should be tested and a 1 added to accumulator position 09 if an overflow has occurred. After the quotient is half-adjusted the low-order position of the quotient will be found in position 18 of the accumulator track.

Sample Problem No. 2: (Quotient, 11 digits or less)

In this example, weekly earnings are to be divided by total hours worked to arrive at an average hourly rate. The average rate is to be half-adjusted to the nearest cent. Figure 133 shows the divide operation.

Divisor and Dividend Positioning for Quotients of Greater Than 11 Digits

If there is a possibility of developing a quotient of more than 11 digits (when a dividend of over 11 digits is used), it may be necessary to shift the divisor to the left on the multiplicand track, adding significant zeros to position the divisor with the dividend so that the first subtraction does not develop a quotient digit greater than 9. This can be done providing it does not make the largest divisor exceed nine digits. To effect a shift of the divisor on the multiplicand track, it must first be positioned either on a working storage track or in an accumulator with the proper number of zeros to the right, then loaded directly on to the multiplicand track. To position the dividend and divisor in this case, the following rule applies:

RULE 2

Quotient of Greater Than 11 Digits. The low-order position of the dividend will be positioned in L19, and

	Number of Significant Digits	Track Location
Dividend: \$135.68	5 + 1 for half adjust = 6	W00-04
Divisor: 39 hours	2 maximum 1 minimum	Y38-39
Quotient Desired: \$3.478 Half adjusted to: \$3.48	4 - 1 for half adjust = 3	

Instruction	Operation	Accumulator 0	Accumulator 1	Quotient Counter	Time in Milliseconds
W04L1105b5	Load dividend	000000135	6800000000		30
Y39V9902	Place divisor on V track	bbbbbbb39			30
L09P9908	Divide	000000186	8000000003	3	40
		0000000308	0000000034	4	20
		0000000350	0000000347	7	20
		0000000380	00000003478	8	20
Z04L1901	Add constant 5 from Z04	0000000380	00000003483		30
Total:					190 Milliseconds

The quotient in positions 16-18 is \$3.48, and the remainder is 38.

Figure 133. Division Example No. 2

the divisor must be shifted to the left on the V track the number of positions equal to the maximum possible quotient minus eleven.

$$(\text{Number of positions to shift left on V}) = (\text{Maximum quotient digits}) - 11.$$

Sample Problem No. 3

A dividend of fourteen digits and a divisor of from two to four digits are used. The maximum size quotient possible is 13 digits. Using Rule 2, the low-order position of the dividend is positioned in L19. The maximum possible quotient (13 digits) minus 11 is equal to 2.

The divisor is shifted 2 places to the left on the V track by positioning it first in an accumulator.

It should be noted in Sample Problem No. 3 that the low-order position of the remainder is no longer located in position 08 of the accumulator track. If the quotient is more than 11 digits, the units position of the remainder will be one position to the left of the high-order position of the quotient (see Figure 134).

Unworkable Problem Considerations

Division by zero will cause a quotient of all 9's to be developed. If there is a possibility of a divide by zero,

	Number of Significant Digits	Track Location
Dividend: 67942895312489	14	W00-13
Divisor: 2751	4 maximum; 2 minimum	Z00-03
Quotient Desired: 0024697526467	13	

Instruction	Operation	Accumulator 0	Accumulator 1	Quotient Counter	Time in Milliseconds
W13L1914b5	Reset accumulators & load dividend	0000006794	2895312489		30
Z03L2704b5	Place divisor in accum to reposition	0000275100			30
L29V9906	Load divisor on V	0000275100			30
L09P9926	Divide	0000067942	8953124890	0	40
		0000679428	9531248900	0	20
		0001292289	5312489002	2	20
		0001918895	3124890024	4	20
		0002682953	1248900246	6	20
		0002070531	2489002469	9	20
		0001448312	4890024697	7	20
		0000728024	8900246975	5	20
		0001779248	9002469752	2	20
		0001286489	0024697526	6	20
		0001869890	0246975264	4	20
		0002102900	2469752646	6	20
		0001772002	4697526467	7	20

Total: 370 Milliseconds

The quotient in position 07-19 is 0024697526467, and the remainder is 1772.

Figure 134. Division Example No. 3

the program must test for the zero condition. This may be done by testing for blank transmission when the divisor is transferred to the V track.

If the rules for placement of the dividend and divisor are not followed, or the relative sizes for each vary beyond the prescribed limits of the original problem planning, all 9's may be developed because the divide operation will attempt to create a quotient digit greater than 9 on each quotient-digit-cycle.

Alternate Method of Divisor and Dividened Positioning

An alternate method which may be used for determining the placement of the dividend and divisor is detailed step by step below. This second method has the advantage of presenting a more visual representation of the problem and solution. It also automatically compensates for divisor and dividend placement in problems where specific limits have been set on the quotient size (for example, where the quotient is average unit cost and can never exceed \$999.99).

EXAMPLE 1 (QUOTIENTS 11 DIGITS OR LESS)

1. Lay out the problem as a simple long division using a divisor of *maximum size*, a dividend of *maximum size*, and the *maximum* quotient. Although all three of these conditions could never exist in any one problem, this procedure will allow proper alignment for programming purposes. Assume a problem with a 4-digit divisor, an 8-digit dividend with two decimal places, and a possible quotient of 7 digits.

$$\begin{array}{r} \text{XXXXX.XX} \\ \text{XXXX} \overline{) \text{XXXXXXXX.XX}} \end{array} \text{ or } \begin{array}{r} 00539.69 \\ 0012 \overline{) 006476.36} \end{array}$$

(Always align the units position of the quotient and the units position of the dividend.)

2. Add zeros to the right of the dividend if a larger quotient is required for half-adjusting.

$$\begin{array}{r} \text{XXXXX.XXXX} \\ \text{XXXX} \overline{) \text{XXXXXXXX.XX00}} \end{array} \text{ or } \begin{array}{r} 00539.6966 \\ 0012 \overline{) 006476.3600} \end{array}$$

In this case it is desired to half-adjust to the nearest mil.

3. Place the divisor under the dividend aligning the units position of the divisor under the first position of the quotient.

$$\begin{array}{r} \text{XXXXX.XX00} \\ \text{XXXX} \overline{) \text{XXXXXXXX.XXXX}} \\ \text{XXXX} \end{array} \text{ or } \begin{array}{r} 00539.6966 \\ 0012 \overline{) 006476.3600} \\ 0012 \end{array}$$

4. Draw a vertical line to the right of the high order quotient digit.

$$\begin{array}{r} \text{X} \text{XXXX.XXXX} \\ \text{XXXX} \overline{) \text{XX} \text{XXXX.XX00}} \\ \text{XXXX} \end{array} \text{ or } \begin{array}{r} 0 \text{0539.6966} \\ 0012 \overline{) 00 \text{6476.3600}} \\ 0012 \end{array}$$

5. This line defines the location of the dividend in accumulators 0 and 1.

		X	X	X	X	X	X	X	X												
	08	09	10	11	12	13	14	15	16	17	Accum. Pos.										
XXXX	X	X	X	X	X	X	X	X	0	0											
X X	X	X																			

or

			0	5	3	9	.	6	9	6	6										
	08	09	10	11	12	13	14	15	16	17											
0012	0	0	6	4	7	6	.	3	6	0	0										
0 0	1	2																			

6. The line also defines the position of the divisor on the multiplicand track.

				X	X	X	X	X	X	X	X	X	X									
XXXX	X	X	X	X	X	X	X	X	0	0												
	96	97	98	99	Multiplicand Track																	
X X	X	X																				

or

					0	5	3	9	.	6	9	6	6								
0012	0	0	6	4	7	6	.	3	6	0	0										
96	97	98	99																		
0 0	1	2																			

EXAMPLE 2 (QUOTIENTS OF GREATER THAN 11 DIGITS)

1. If the quotient digits to the right of the vertical line exceed ten, then a second line must be drawn to allow only ten right-hand digits. These ten positions will be in accumulator 1. This would happen when the quotient is large as illustrated below.

$$\begin{array}{r} \text{XXX} \text{XX.XXXXXXXXXX} \\ \text{XXXX} \overline{) \text{XXXX} \text{XX.XX000000}} \\ \text{XXXX00} \end{array}$$

or

$$\begin{array}{r} 005 \text{39.69666666} \\ 0012 \overline{) 0064 \text{76.36000000}} \\ 001200 \end{array}$$

2. Note that the divisor must be positioned two places to the left on the multiplicand track, so that the first quotient digit will not exceed 9.

			X	X	X	X	X	X	X	X	X	X	X	X	X	X	X	X	X
	06	07	08	09	10	11	12	13	14	15	16	17	18	19					
XXXX	X	X	X	X	X	X	X	X	0	0	0	0	0	0					
	94	95	96	97	98	99													
	X	X	X	X	0	0													

Multiplicand Track

or

			0	0	5	3	9	6	9	6	6	6	6	6	6	6	6	6
	06	07	08	09	10	11	12	13	14	15	16	17	18	19				
0012	0	0	6	4	7	6	3	6	0	0	0	0	0	0				
	94	95	96	97	98	99												
	0	0	1	2	0	0												

ADDITIONAL 350 DISK STORAGE

ONE ADDITIONAL IBM 350 Disk Storage Unit may be attached to the RAMAC to increase storage capacity from 50,000 up to 100,000 (100-character) records. The 50 additional disks, which are housed in a separate storage frame similar to the present 350 Disk Storage Unit, uses addresses from 50000 to 99999. One common address register is used for both files; however, each disk storage unit has its own address control register which is selected after analyzing the disk address to determine whether the address is above 49999 or below 50000. Programming remains the same as with a single disk storage unit. The subtraction of 5 from addresses above 4 in the high-order position of the address has been removed so that addresses of 50000 or over will select disk records located in the second file.

In general, systems with both disk storage units are programmed as if they were a single storage unit with 100 disks and a single arm. When the arm has moved to the desired address, the record is transferred to the process unit, processed, and then written back on the disk before seeking another record. The same average access time of approximately 600 milliseconds also applies to the second file.

It is not possible to have the access arms on both files moving at the same time. When two successive address instructions involving different files are given, the machine interlocks and the second arm will not move until the first arm has completed its seek. The record transferred to or from the disk storage is the one specified by the last address sent to the address register. Thus, if a seek is initiated in file one, the record read out, and a seek initiated in file two, file one must be readdressed

with the original address before the updated record can be rewritten in file one. Subsequently, file two must be addressed with the original address before reading out for processing. If the arms stay at the same location during processing there is no increase in access time, and only the time required to readdress the files is added to processing.

Readdressing must be adhered to in order to avoid writing records in incorrect locations.

An independent line cord is necessary to provide power to the additional disk storage unit, and data is transmitted through cables connected to the standard 350 Disk Storage Unit. Both disk storage units run continuously as long as power is on at the console.

DUAL ACCESS

ONE ADDITIONAL access mechanism is available as a Special Feature for each IBM 350 Disk Storage Unit attached to the 305 RAMAC system. With the addition of the second access arm (Figure 135), it is possible to have one access unit in position for reading or writing on a record while the other unit is moving to the next record. Normally, the units are addressed on an alternating basis so that processing for one record will overlap the seek for the next record. Dual access is particularly useful in applications where processing has not been continuous because access time for an item exceeds the amount of processing time required.

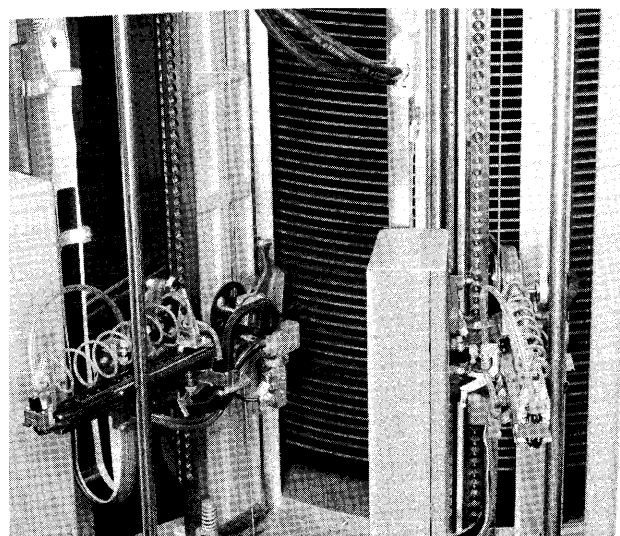

Figure 135. Dual Access Units

The two access units, (0 and 1) Figure 136, are controlled by individual address registers operating in conjunction with a single J address register or buffer. When a seek instruction is initiated, the address is carried to the J address register where it is, in turn, automatically directed to one of the individual address registers and the seek begins. The movement of the access unit is then under complete control of the address in its individual register, and the seek will not be disrupted by changes to the common J register or by read/write instructions which affect the other access unit.

There are two basic modes of operation with dual access:

1. The automatic sequencing mode in which addresses sent to the J address register alternate automatically between access unit 0 and 1, using first one and then the other.
2. The select mode where the control panel hubs provided for dual access are used to select the access unit which is to receive the next address to the J register.

Under the select mode, it is also possible to assign one access unit for operating through the entire program, simulating a standard single access system. In addition, selectors may be used to select either automatic sequencing or the select mode for operation within the same program.

Automatic Sequencing

When a disk storage unit is equipped with both access arms, the normal operation (requiring no additional control panel wiring) is automatic sequencing. An instruction which sends an address to the address register performs two functions:

1. It directs one of the access units to the record designated by the address.
2. It conditions the other access unit so that the next reference to the file (R instruction) will refer to the

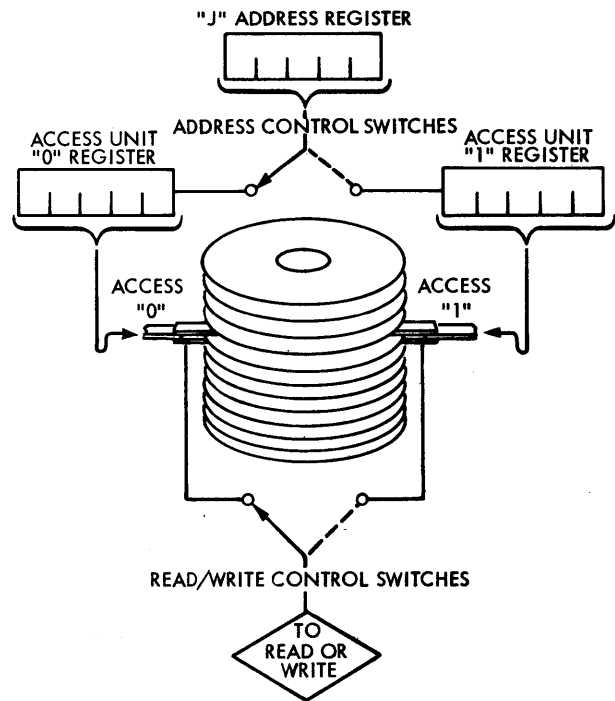
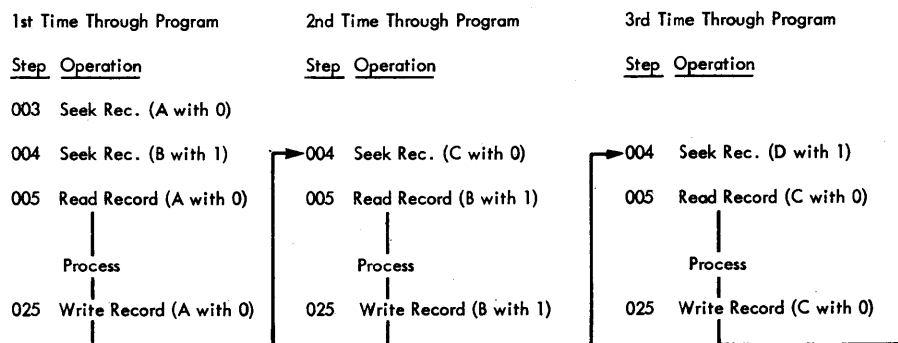

Figure 136. Schematic of Dual Access Units

record located by the previous seek instruction rather than the access unit in the process of performing a seek.

With the switches in the positions shown in Figure 136, an address received by the J address register would be directed to the 0 access register and the seek would begin. As soon as the seek has begun, both the address control and the read/write control switches transfer to access unit 1.

Because addressing of the access is internally controlled, programming dual access is much the same as programming a single faster access. However, to begin the cycle, two seek instructions, without an intervening read or write instruction, must be given. The first seek operation is then bypassed in processing succeeding items through the loop. For example:



The first seek instruction following a reset condition will be directed automatically to the 0 access unit. On the next seek instruction in the program, access 1 will seek the address sent to the address register and access unit 0 will be conditioned to read or write. Therefore, the next read or write instruction issued will apply to access 0.

A control code 4 in the 10th position of a seek (J) instruction will suppress switching of the read/write mechanism to the other access unit, and the same record which is being sought will be read by the following R instruction. On the next J instruction without a 4 control code in the 10th position, the system will resume alternate use of the access units.

The control code 4 is particularly useful in restart procedures and substitution routines where both seeking and reading or writing of the affected record must be accomplished by the same access unit to avoid getting out of step in the main program.

If provision is made for inquiries in a program utilizing two access units as a sequencing device, Inquiry should be tested prior to a J instruction. If a request for inquiry has been made, the access unit used for the last read or write will perform the seek and the read for the inquiry. The program is then resumed using the same access unit for the next J instruction.

Record Advance and Skip-To-Record may be used in an automatic sequencing program just as they are with a single access system. Because only a programmed instruction to the address register will cause switching of the read/write mechanism to the other access unit, the access arm used on the instruction which impulses Record Advance or Skip-To-Record will also locate and read or write the new record before switching resumes.

Select Mode of Operation

The programmer may find it useful to select a particular access unit for operation in a specified area of the program. With the addition of five hubs to the process panel, dual access can be controlled in a select mode.

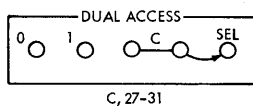

The common (C) hubs emit an impulse which must be wired to select (SEL) if the system is to operate in the select mode; when this switch is unwired, dual access operates as an automatic sequencing device.

The 0 and 1 hubs activate their respective access arms when impulsed in the select mode. These hubs are normally wired from either Program Exits or the common "C" hub of the dual access group; they may be wired from any impulse *originating* on the 305 process control panel with the exception of control impulses (CI) and the upper hub of the Inquiry ON switch.

The functions of these hubs in the select mode are detailed in the following descriptions of each operation.

Dual Access as Single Access System

In the select mode, a single access unit can be used throughout a program by wiring C to either 0 or 1, depending upon which unit is desired, and wiring the select switch (C to SEL) on, Figure 137. The system will then function exactly as a standard single access system.

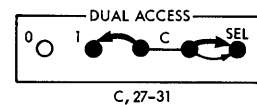

Figure 137. Using Only Access Unit No. 1

Selective Use of Access Units

In some applications time is saved by assigning one access unit to a particular location in the file referred to only in alternate routines, with the other access unit functioning for the normal routines of the program. In this way, running from one section of the file to another can be avoided and considerable time saved when substitute routines are required for processing. For example, in the transportation industry scheduled runs and their corresponding seat reservations can be grouped in one area of the file for processing. When all reservations are sold for a particular run, substitute routines can be transferred from a separate section of the file quickly if an access unit is already waiting in that area. The access unit reserved for the scheduled reservations is not disturbed and can resume normal processing without losing the time required to leave its assigned area and return.

For this type of operation, the C to SEL switch is wired on the control panel. After one of the access unit hubs, either 0 or 1, receives an impulse, the corresponding access unit will accept all J, Record Advances, Skip-To-Record, and R instructions until the other access unit hub is impulsed, Figure 138.

When used in this manner, the first access unit impulsive in the program should be 0 because an interlock will occur if arm 1 is used before arm 0 after turning power on. However, if arm 1 is used first, the interlock may be released and the program continued without error by depressing Check Reset and then Program Start.

In addition to assigning access 0 or 1 using program exit impulses, either the Program Exit or the C hub may be selected to activate an access unit on the basis of conditions arising during processing, Figure 139.

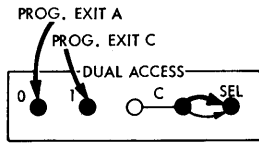

Figure 138. Program Exit Selection of Access Units

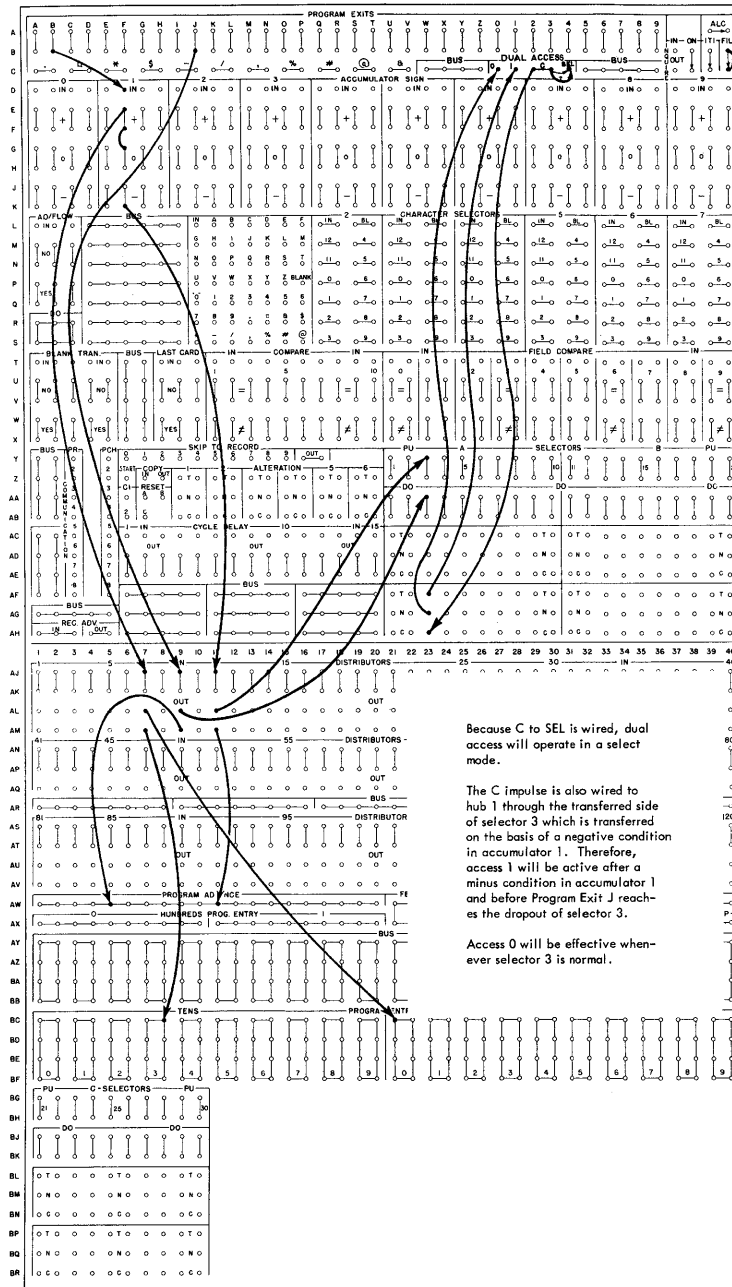

Figure 139. Selection of Access Units

Combining Sequencing and Selective Use of Access Units

The C to SEL switch can be selected and may be wired through the normal or transferred points of a selector. Therefore, the dual access units may be used as a sequencing device as well as individual units within the same program by selection of the C to SEL switch, Figure 140.

Impulses to the 0 and 1 hubs need not be selected, because the hubs are not effective when C to SEL is not wired.

The mode of operation must be established *before* either arm 0 or 1 is impulsed or before automatic sequencing of the access arms can be expected; therefore, any impulse to the pickup or dropout of a selector used to select the C to SEL switch cannot be the same impulse

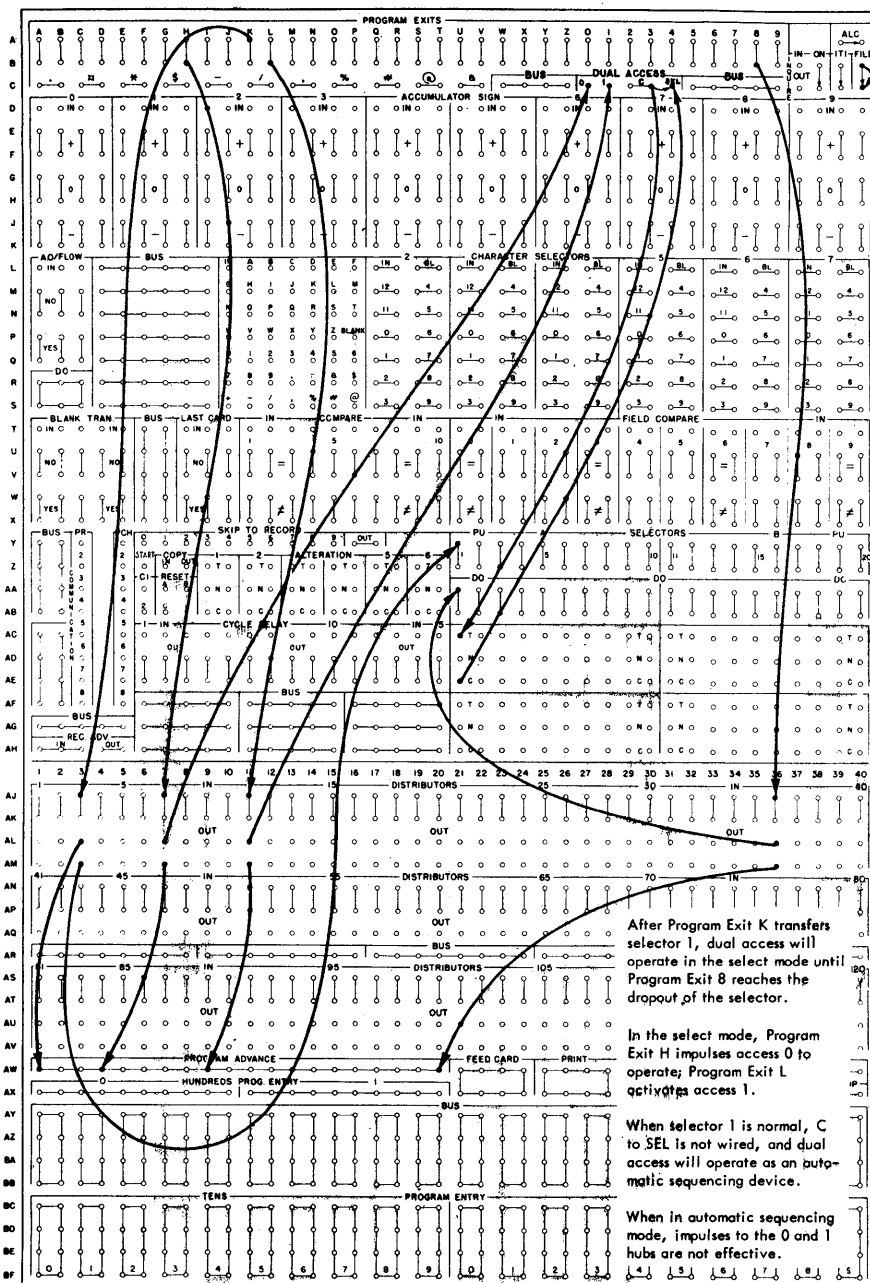

Figure 140. Combining Automatic Sequencing and Select Mode

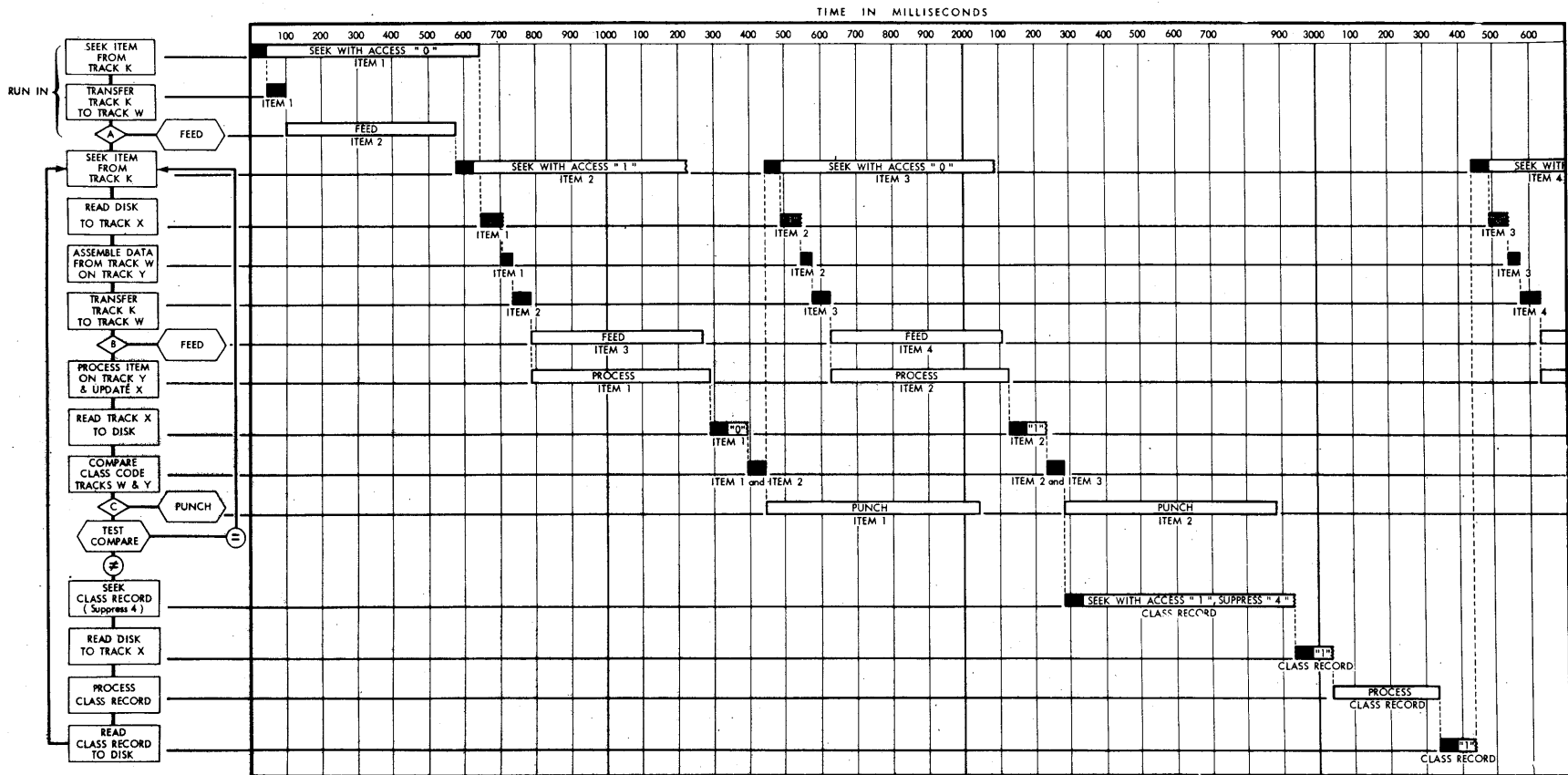

Figure 141. Sample Program — Dual Access

wired to the 0 or 1 hub unless a cycle delay is used. When an impulse performs two such functions, the branch wired to the function which is to occur last should be cycle delayed.

Sample Problem

To illustrate the overlapping possible with the dual access feature, a sample inventory control problem utilizing automatic sequencing is presented in the general block diagram and timing chart, Figure 141.

In this example, single item cards enter the system in class groups; item records in the file are updated, and a card is punched for each item. When a class change is recognized, the class record is transferred from the file and updated.

With single access, one item is normally processed on a working track while the next item is being fed to K; therefore, only two items are active in the system. Because two items, in addition to the card being fed to the K track, are required to take full advantage of overlapping with dual access — the one being processed and the other for which the seek is performed — two work-

ing tracks in addition to K are used. There are three items in or entering the system at all times:

1. The card feeding to the K track.
2. The card on the first working track (W), which is held there until the seek (started when it was on K) is completed. It also is compared against the card ahead for a change in class code while on the first working track.
3. The card, on the second working track (Y), which is actually being processed.

The feed instruction is given early enough in the program to complete card feeding before the seek instruction from K is given so that there is no interlock delay.

The program loop in this particular problem, although not detailed completely, requires approximately 860 milliseconds.

A 4 code in the 10th position of the instruction which seeks the class record suppresses switching of the Read/Write control. By using one access unit for seeking, reading, and writing the class record, sequential processing of the input items does not get out of step.

Control Panel Summary

EACH SECTION of the control panels is assigned a number under which the hubs are briefly described.

Process Control Panel (Figure 142)

1. **Program Exits.** These hubs emit an impulse whenever the corresponding program exit occurs in an instruction. The impulse is used to make tests on the control panel, and to transfer the program control to the first step of a new sequence of instructions. When one of these hubs emits, the program sequence is halted, and must be restarted by impulsing program advance or by impulsing program entries.

2. **Accumulator Sign.** Each accumulator has an associated selector that shows its sign. By using a program exit impulse, a test may be made to determine if an accumulator is positive, stands at zero, or is negative.

3. **Accumulator Overflow.** Whenever an accumulator overflows (tries to accumulate a number beyond its capacity), a path is established between each IN hub and its YES hub. These paths remain set up until the accumulator overflow selector is dropped out by impulsing DO. A normal path is established between the IN hub and the corresponding NO hubs when the selector is dropped out or when no overflow has occurred.

4. **Character Selectors.** The character selector provides a way of analyzing any character on a drum track. The position to be analyzed is entered into this unit by an instruction with hyphen (-99) as the TO address. Any character entered establishes test paths between each IN hub and the exit hubs corresponding to the character entered.

Four distinct paths are set up on the basic machine. Three of the paths are arranged so that a test impulse entered into the IN hub emerges from the hubs corresponding to the IBM card code of the character being tested. In the fourth path, an impulse wired into the IN hub emerges from one of the 48 exit hubs representing the specific letters, numbers, and special characters (including blank). The test paths remain set up until another character is addressed to the unit.

5. **Blank Transmission.** A 6 in the tenth position of an instruction causes the Blank Transmission selector to reset to a NO condition. If the information transferred from the core storage during the execution of the instruction is all zeros or blanks, the selector will transfer to a YES condition and the BLANK light on the 380 Console will be turned on. The selector will remain transferred and the light will remain on until another instruction with a 6 is read.

6. **Last Card.** This selector is used to control machine operation on the run-out. Normally, a path exists between each IN hub and the NO hub beneath it. When the cards have run out of the card reader hopper, and the last card has passed the second reading brushes, if no more cards are to be entered, the operator may depress the reader

start key and feed the last cards to the stacker. After the start key has been depressed, the last card selector transfers. The program control may be wired through this selector to control the run-out.

7. **Compare.** This selector stores the result of the last programmed comparison. A path is set up between each IN hub and the = (equal) hub beneath it whenever the two fields are exactly equal, and between the IN hubs and their \neq (not equal) hubs when the two fields fail to compare. These paths remain set up until another programmed comparison is made.

8. **Field Compare.** The field compare device is provided to allow, with one instruction, from one to ten fields on the track specified by the FROM address to be individually compared with the fields of a track specified by the TO address. The FROM address may refer to a process drum track, a disk track, or the core unit. The TO address may specify any process drum track other than the accumulator track. Neither the core unit nor the disk file may be used as the TO address. A 2 code is placed in the tenth position of the instruction to cause automatic field comparing. The results of a field comparison will be indicated in the ten selectors associated with the field compare device.

9. **Communication.** These hubs are connected to the correspondingly numbered hubs of the communication section on the printer, console, and punch control panels. They allow for signal communication between the machine units.

10. **Skip-To-Record.** When one of the numbered hubs associated with Skip-To-Record is impulsed, the access arm remains on the same disk and track, but the disk address register is advanced so that the units position of the disk address corresponds to the number of the hub impulsed.

After the corresponding address has been set up in the address register, the OUT hub emits. This impulse is wired to restart the program. Normally, this device will be used in conjunction with FIELD COMPARE.

11. **Record Advance.** These hubs advance the address in the address register one sector per impulse. This feature is used mainly to obtain additional sectors where a record is spread over more than one sector. When the IN hubs are impulsed, the address in the address register is advanced one sector on the same track. When the advance is completed, the OUT hubs emit an impulse that is wired to restart the program. When the advance goes from sector 9 to sector 0, the O/F hub emits instead of the OUT.

12. **Alteration.** A row of switches on the operator's panel at the console is provided to allow various changes to be made in the program setup by changing the settings of the switches. On the control panel, these switches are wired in a manner similar to selectors. Program exit impulses wired into the C hubs emerge from the N (normal) hub of the same vertical row if the corresponding toggle switch is in the normal position. They emerge from the T (transferred) hub if the toggle switch is transferred.

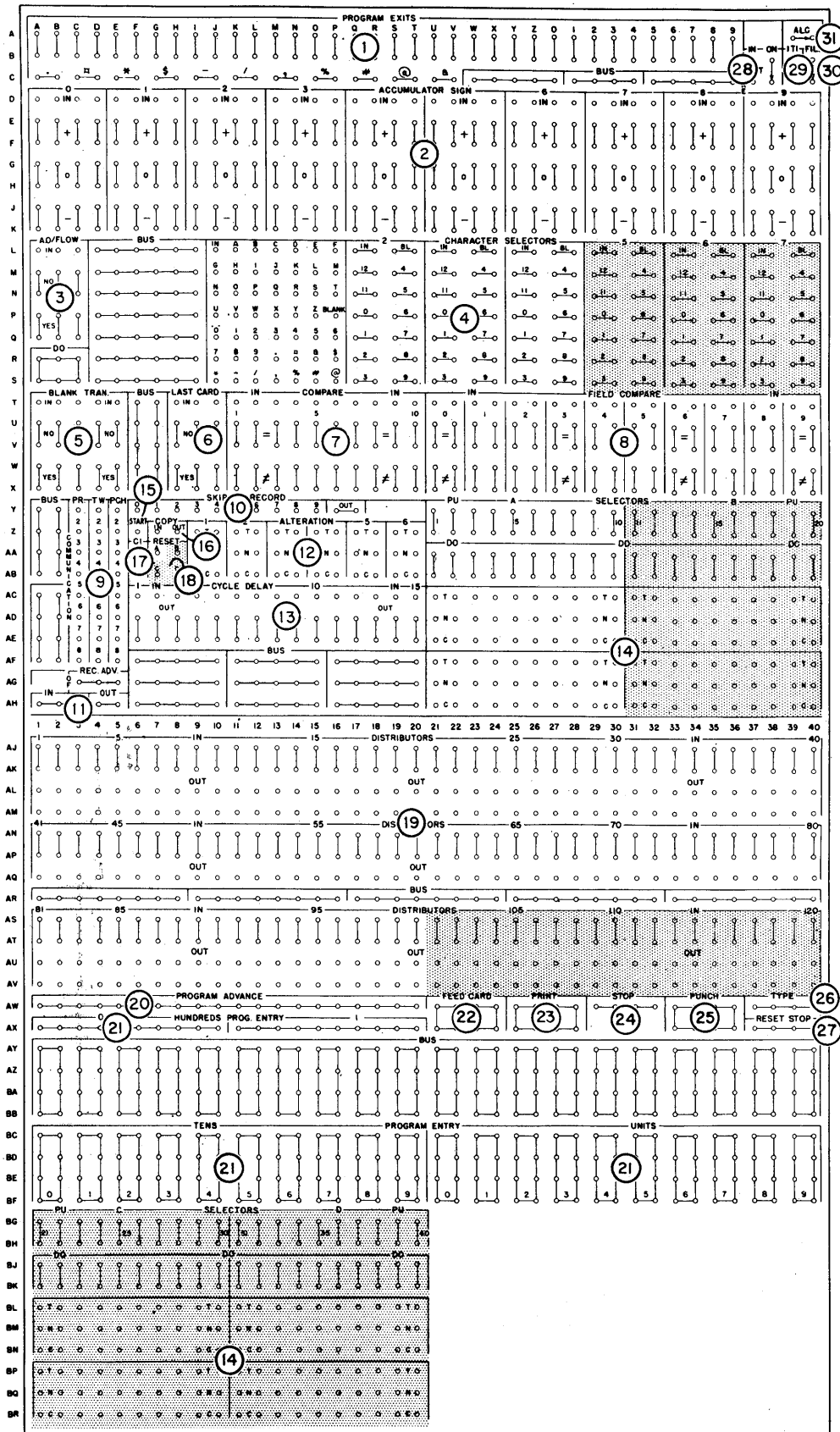

Figure 142. 305 Process Control Panel

13. **Cycle Delay.** These units provide a delayed impulse that may be used for control functions, such as the pickup and dropout of selectors. An impulse wired into the cycle delay IN hub emerges from the OUT hub thirty milliseconds later, where it may pick up or drop out selectors after the control impulse has ended. Whenever Cycle Delay is impulsed, programming must be advanced by the delayed OUT impulse.

14. **Selectors.** Latch-type selectors are furnished to provide for storage and for analysis of control. Each selector position has a COMMON, a NORMAL and a TRANSFERRED hub. The COMMON hub is connected to the NORMAL hub until the selector is picked up by impulsing the PICKUP hub. Then the COMMON hub is connected to the TRANSFERRED hub until the DROPOUT hub is impulsed.

15. **Start.** When the first input card after any run-out except non-process run-out has been read and checked, an impulse is emitted from this hub. This impulse is used in the same manner as a Program Exit impulse to start the stored program at the desired instruction.

16. **Copy.** When the COPY IN hub is impulsed, the machine automatically transfers the contents of the input track to track I of the program storage tracks. If the input card is punched with instructions, this records instructions 190-197 on track I. The IN hub may be impulsed from the START hub.

When the transfer to track I is completed, the OUT hub emits an impulse that is wired to start the stored program at any step. Usually it is wired to start the program at step 190.

17. **CI (Control Impulse).** Two buttons are provided on the operator's panel at the console to allow a control impulse to be emitted on the control panel. This allows the operator to pick up or drop out selectors, or initiate other functions from the console. These impulses are emitted from the correspondingly numbered CI hubs on the control panel.

18. **Reset.** When impulsed, this hub causes the corresponding group of ten selectors to be dropped out.

19. **Distributors.** Impulses that are used to initiate several functions are wired through distributors that serve the same function as split wires but prevent possible back circuits. An impulse wired into the IN hub of a distributor is available at the associated OUT hubs, but impulses cannot travel between OUT hubs, or from an OUT hub to the IN hub. Any impulse except that from the OUT hub of another distributor may be wired through a distributor.

20. **Program Advance.** The stored program sequence is halted when the control is brought to the control panel as an electrical impulse. To restart the program at the next higher step, the Program Exit impulse is wired to impulse PROGRAM ADVANCE.

21. **Program Entry.** When the program control has been brought to the control panel on a Program Exit, a new program sequence may be started by impulsing the appropriate program entries.

The hundreds program entry is impulsed only when it is desired to change program steps from steps below number 100 to steps above 100, or vice versa.

The new program step is set up by impulsing the tens and units hubs that correspond to the number of the program step desired. Distributors should be used.

22. **Feed Card.** Impulsing these hubs causes the card reader to feed a card past each station. The card passing first reading is automatically coded and recorded on one input track, while the card passing second reading is checked against the recording on the other input track that was recorded from that card on the previous card-feed cycle. When the card passing second reading has been checked, its input track is made available to the processing unit.

23. **Print.** Impulsing these hubs causes the printer to print from the output track. Format control on the printer determines the arrangement of the printing.

24. **Stop.** When these hubs are impulsed, the program will stop. If the program is advanced with the same program exit which impulses stop, the program may be restarted by depressing the program start key.

25. **Punch.** Impulsing these hubs causes the 323 Punch to punch from the output track. Wiring on the punch control panel determines which columns are punched.

26. **Type.** When the typewriter at the console prints an auxiliary document, impulsing these hubs causes the typewriter to print the information recorded on the Q track. Format control on the typewriter control panel determines the arrangement in which this information is typed.

27. **Reset Stop.** These hubs may be impulsed from a stored program exit impulse when processing is to be halted. Impulsing these hubs resets the processing unit and places the machine in an inquiry-only mode of operation so that inquiries may be made. Restart by depressing the reader start key with cards in the hopper and the feed clear.

28. **Inquire.** The pair of hubs marked ON form a switch that is jackplugged if manual inquiries to the disk records are to be allowed during processing.

The IN-OUT hubs form an interlock that is wired to allow the console to take control of the access arm at a time when it will not countermand the stored program instructions. The INQUIRE interlock is wired in the program at a point where the access arm has completed its use of the record. If the arm is about to be moved by the program, no harm will be done if the operator moves the access arm to some other record to make an inquiry. When the record has been obtained for the operator, the stored program resumes control and moves the arm to the next record required.

A program exit wired into the IN hub emerges immediately from the OUT hub if no inquiry has been set up at the console. The impulse from the OUT hub is wired to initiate the next program step.

29. **ITI (Inquiry-Type Interlock).** The typewriter may be used to make inquiries to the disk records as described in item 28. The typewriter may also be used as a secondary output printer by addressing the output record to Q track and impulsing TYPE on the control panel (see item 26). If both of these uses occur in the same program, the inquiry-type interlock must be jackplugged to prevent an inquiry from taking place while the typewriter is under program control.

30. **File Interlock.** This interlock is provided so that new programs may be tested without changing the information on the disks. When a program has been checked out, this switch is wired to allow the disk records to be changed. All operations except writing on the disks may be performed with the interlock off. A write operation will cause a FILE CHECK.

31. **ALC (Automatic Last Card).** If the ALC switch is not plugged (when the cards have run out of the card reader hopper, and the last card has passed the second reading brushes), the card reader will stop. The operator may depress the reader start key, and feed the last cards to the stacker. Just after the operator depresses the start key, the last card selector transfers.

If the ALC switch is plugged, the card reader will feed cards for one additional cycle before stopping. During this additional cycle the last card selector transfers, and any last-card routines that have been programmed utilizing the last card selector can be completed. The cards may then be fed into the stacker by depressing the reader start key.

Printer Control Panel (Figure 143)

1. **Print Control Exits.** These hubs emit control impulses as the printer is positioned to print the corresponding positions of the print line. Each hub emits one impulse per line printed; for example, hub five emits an impulse every time print position five is being set up.

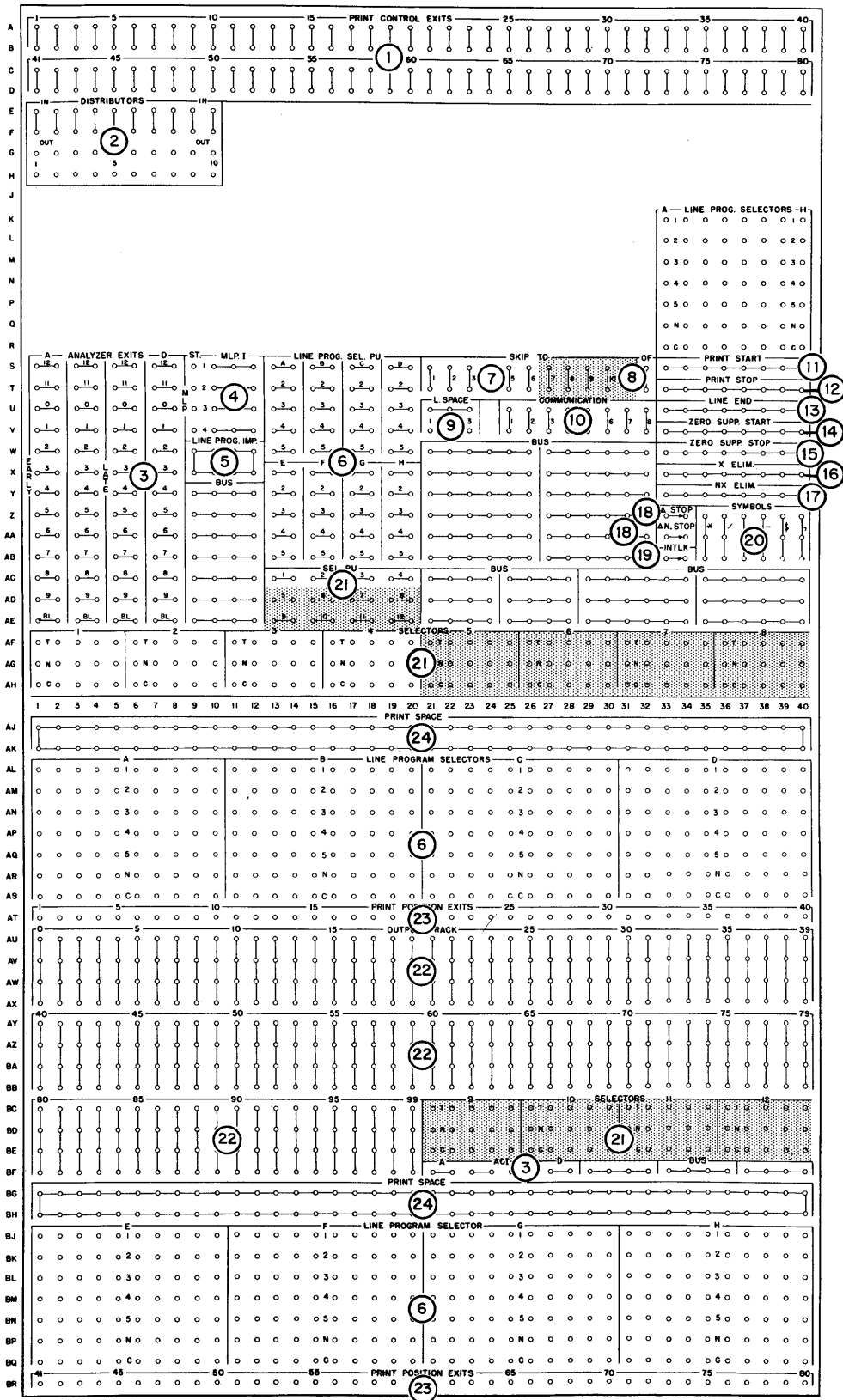

Figure 143. 370 Printer Control Panel

These impulses are wired to initiate functions such as zero suppression, X-elimination, etc.

2. **Distributors.** Impulses that are used to initiate several functions are wired through distributors that serve the same function as split wires but prevent possible back circuits. An impulse wired into the IN hub of a distributor is available at the associated OUT hubs, but impulses cannot travel between OUT hubs, or from an OUT hub to the IN hub. Any impulse except that from the OUT hub of another distributor may be wired through a distributor.

3. **Analyzers.** When a record has been transferred to the output track, and PRINT on the process control panel has been impulsed by a control code, the printer prepares to print a line. However, before the print mechanism moves from the home position, the output track may be analyzed.

By wiring from the ACI hubs of an analyzer to an output track position, the digit or character in that position of the output track will condition the analyzer so that the ANALYZER EXITS will emit in IBM code. The 2 exit emits for a 2, the 12 and 1 exits emit for an A, etc. If ACI is not wired to an output track position, blank will emit on each print cycle except MLP 2, 3, and 4.

4. **MLP (Multiple-Line Print).** The MLP unit controls the printing of multiple lines from a single output track. The START hub that corresponds to the number of lines desired is impulsed from an ANALYZER EXIT. The MLP I hubs emit an impulse at the beginning of the corresponding MLP line, in sequence 1, 2, 3, 4, up to the number of lines desired. These exit impulses are wired to pick up line program selectors to control the format on the corresponding print line.

5. **Line Program Impulse.** This impulse is available during the analysis portion of the print cycle. It is, however, inactive if MLP START has been previously impulsed. During an MLP operation, the MLP IMPULSE hubs emit, and the LINE PROGRAM IMPULSE hubs are inactive.

6. **Line Program Selectors.** The line program selectors are provided to allow format control of the information being printed from the output track. Each selector has eleven positions; ten of these are grouped near the output track and an eleventh position of each selector is near the control section. Each position has a COMMON hub, a NORMAL hub, and five TRANSFERRED hubs. The COMMON hub is connected to the NORMAL hub until one of the five pickup hubs is impulsed, usually from the MLP I hubs. Then the COMMON hub is connected to the correspondingly numbered TRANSFERRED hub above it. The selectors remain transferred until the line is printed and drop out as the print head returns to the home position.

7. **Skip-To.** These hubs are impulsed from ANALYZER EXITS or from 305 control impulses wired through communication channels to cause the tractor to feed the paper in the printer to the corresponding hole in the control tape. In the carriage control tape, channels 1-6 stop the corresponding skips. Channel 12 in the control tape causes an impulse to be emitted from the OF (Overflow hub) that may be wired to advance the paper to the first printing line on the following form.

8. **OF (Overflow).** When a hole is sensed in the 12 channel of the carriage control tape, during the analysis portion of a print cycle, it causes an impulse to be emitted from these hubs. The impulse may be wired to cause the paper to be skipped to the first line of the following form by impulsing one of the SKIP-TO hubs, and placing a hole in the control tape in that channel to stop the tape at the proper place. The OF impulse may also be wired through communication channels to the processing control panel, where it may pick up a selector that is tested in the course of the program to determine if the overflow condition exists. Then steps in the program can decide whether to complete the form or start the following form. If the printing is to overflow to the next form, the processing unit can, by program exits wired through communication channels, control the overflow skip.

9. **Line Space.** To allow variable spacing, the space control impulses are wired on the control panel. A jackplug may be inserted between one of the numbered hubs and the SPACE hub above it to cause single, double, or triple spacing. Alternatively, the space control wiring may be selected to allow variable spacing.

10. **Communication.** These hubs connect to the correspondingly numbered hubs on the 305 Process Control Panel to allow signal communication between the processing unit and the printer.

11. **Print Start.** These hubs are impulsed from PRINT CONTROL EXITS to start printing at any desired column as the print head moves across the paper. Once the printing is started, the machine will continue to print until printing is turned off by impulsing PRINT STOP. In this way, printing can be turned on and off several times in the course of printing a line to give added flexibility in format control. The PRINT CONTROL EXIT for the first column of each field to be printed is wired to these hubs.

12. **Print Stop.** These hubs are impulsed from the PRINT CONTROL EXIT of the first position not to be printed, to turn printing off, when other information is to be printed later on the same line. Impulsing these hubs causes printing to be suppressed until PRINT START is impulsed.

13. **Line End.** These hubs are wired from the PRINT CONTROL EXIT of the position after the last position to be printed on a line to cause the printing to stop and the print head to return to the home position. This allows the length of the printing line to be controlled. Variable printing lengths are possible by wiring LINE END through selectors.

14. **Zero Suppression Start.** These hubs are wired from the PRINT CONTROL EXIT of the high-order position of a field to eliminate the printing of zeros to the left of significant digits. When these hubs have been impulsed, the print unit spaces over positions containing zeros until a significant digit (1-9) is encountered and printed; then all zeros to the right of the significant digit are printed.

15. **Zero Suppression Stop.** Once ZERO SUPPRESSION START has been impulsed, zero suppression will continue until a significant digit (not zero) is encountered and printed or until it is ended by impulsing these hubs from the PRINT CONTROL EXIT of the first position not to be suppressed.

16. **X-Eliminate.** Negative numbers are recorded on the output track (as on all other processing tracks) by an X-bit over the low-order position. For example, the amount 125 stands on the output track as 12N. The X-ELIMINATE and NX-ELIMINATE hubs allow the printer to read the X-punch or the digit punch from an output track position to separate the signed character into its sign and digit components. These hubs are impulsed from PRINT CONTROL EXITS to cause only the digit portion of the character being set up to be printed.

17. **NX-Eliminate.** These hubs are impulsed from the PRINT CONTROL EXITS to allow only the sign portion of a character to be printed (item 16).

18. **Δ (Delta).** When the two hubs labeled Δ Stop are jackplugged, if a print setup error occurs, the machine will print a Δ in the left-hand margin opposite the line in error and the machine will stop.

When the two hubs labeled Δ N. Stop are jackplugged, the machine will print a Δ, but will not stop when a print setup error occurs.

If neither Δ STOP nor Δ N. STOP are plugged, the machine will stop, but a Δ will not be printed if a print setup error occurs.

19. **INTLK (Interlock).** These hubs must be jackplugged before any printing operation can be initiated. The printer will not operate if these hubs are left unplugged.

20. **Symbols.** These hubs are wired from the PRINT CONTROL EXITS to cause the corresponding symbol to be printed. These symbols may be selected through the line program selectors.

21. **Selectors.** These selectors may be used to supplement the line program selectors. Each selector has five positions, and each position has a COMMON, a NORMAL and a TRANSFERRED hub. Normally, a connection exists between the COMMON and the NORMAL hub, but when the PICKUP hub is impulsed, this connection is broken and a connection is made between the COMMON and the TRANSFERRED hub in the same vertical column. The selectors may be picked up in the same manner as the line program selectors, and they remain transferred for the entire print line.

22. **Output Track.** At each printing position, the output track is read in its entirety, but only one character is selected for printing. This selection is made by wiring the hub corresponding to the output track position desired to the PRINT POSITION EXIT corresponding to the printing position where the character is to print.

23. **Print Position Exits.** These hubs are wired from the output track (item 22) to cause the corresponding positions to be set up to print information on the output track. For example, to print position 10 of the output track in print position 50, OUTPUT TRACK 10 is wired from PRINT POSITION EXIT 50.

24. **Print Space.** All print positions that are not wired from the output track should be wired to these hubs. This indicates to the checking circuits that the printer is not to print in the corresponding column, and allows the checking circuits to detect any position that was wired to print and failed to set up correctly.

Punch Control Panel (Figure 144)

1. **Output Track.** These hubs emit the IBM codes of the information on the output track. These exits may be wired to the punch magnets to cause punching. This allows any of the 100 output track positions to be punched into any of the 80 card columns.

2. **Digit Selector.** The D1 hub at the top of the panel emits a series of impulses which are timed for punching the digits 12 through 9. If the D1 hub is wired to the C hub beneath it, the digit selector becomes a digit emitter with a 12 impulse available at the 12 hub, an 11 impulse available at the 11 hub, etc. If an output track position is wired to the C hub, whatever digit or character appears at that output track position will be made available in IBM code at the numbered hubs of the digit selector.

3. **Sign Conversion.** Within the system, the 12 holes are coded by a combination of X- and 0-bits. Also, sign control on negative fields is maintained by carrying an X-bit over the low-order position. If the low-order position of a field is zero and the field is negative, a 12-hole would be punched if this position were wired directly to a punch magnet. The sign conversion hubs are provided so that the 12-impulse available from the output track may be converted to the X/0 code desired for these positions.

In use, the low-order position of any numerical field that may be negative is wired from the output track to an IN hub and from the corresponding OUT hub to the punch magnet. If a 12-code is emitted from this position of the output track, it is punched as X/0. Any other negative number is overpunched with an X. Positive numbers pass through without conversion.

4. **Column Splits.** This is a 10-position selector that is automatically controlled to transfer between X and 0 time as the card is punched. This allows the 12 and X zones to be removed from columns and punched into other columns.

5. **Co-selectors.** As a special device, up to five groups of four 5-position Co-selectors may be installed to allow changes in punching format for different types of cards. Each selector is a five-position selector with two common pickup hubs. Each position has a C (common), N (normal) and a T (transferred) hub. The common hub is connected to the normal hub until the selector is picked up by impulsing the pickup hub. Then the common is connected to the transferred hub.

When the pickup is impulsed, the selector transfers immediately, and will remain transferred for the remainder of the punch cycle.

The Co-selector pickup hubs may be impulsed from any digit impulse, Half-After-Zero, (0.5), Pilot Selector COUPLE, or from the Punch Repeat OUT hubs; however, they should not be impulsed by a 305 Program Exit wired through a Communication Channel. Co-selectors must be used if it is necessary to select BC DET CONTROL wiring when controlling DPBC checking for different card formats, as well as the DPBC STOP, OFFSET, and BC OFF switches.

6. **Punch Magnets.** These hubs are entries to the 80 punch magnets that punch the correspondingly numbered columns of the card. These magnets are wired from the output track positions that are to be punched.

7. **Punch Brushes.** On the punch cycle after a card is punched, it passes a set of 80 reading brushes that read back the information that has been punched so that it may be given the double-punch blank-column check. These hubs are the exits for the reading on this cycle. The information may also be gangpunched back into the following card.

8. **DP & BC Det Entry.** These hubs may be wired from the punch brushes to check individual columns for double punching or lack of punching. This is particularly valuable in numerical fields, where every position must have one and only one hole. If the machine detects multiple punches or lack of a hole in any column wired, it will stop the machine if the control is wired to do so. The DPBC light on the punch unit is turned on to indicate the reason the machine stopped.

9. **BC Det Entry or GP Exit.** If the column being checked is wired into DP & BC DET ENTRY, the first impulse to enter the DP & BC DET ENTRY emerges from these hubs, from which it may be wired to a punch magnet for gangpunching.

If a column, in which double punching is permissible, is to be checked for blanks, these hubs are used as an entry. The first impulse to enter these hubs emerges from the DP & BC DET ENTRY hubs.

10. **BC Det Control.** If no checking for blank columns is to be done, the BLANK COLUMN OFF switch (item 12) must be wired. To check a field for blank columns, wire the field to the ENTRY or EXIT of the DP & BC. If any one field is to be checked, wire it to the left-hand entry positions and, in the blank-column detection control row, wire from the right-hand column of the field to the last position in the row. Several fields can be entered as one field for checking purposes.

11. **DPBC Stop.** When these hubs are jackplugged, the machine will stop if a DPBC error occurs. This switch may be selected if Co-selectors are used.

12. **BC Off (Blank Column Off).** These hubs must be jackplugged to turn the blank column detection feature off when no punched columns are to be checked for blank columns.

13. **Offset.** When the Offset Stacking Feature (special device) is installed, the DPBC Offset switch may be plugged to offset an error card rather than stop. It is also possible to offset different types of cards so that they may be easily distinguished from the main group of cards when removed from the stacker. This switch may be selected; however, Co-selectors must be used.

14. **INT (Interlock).** Whenever the punch is to be used to punch output cards for the processing unit, this control panel switch must be jackplugged.

15. **Gangpunch.** When this control panel switch is jackplugged, the 323 Punch is removed from the control of the processing unit and may be used as an independent gangpunch.

16. **Communication.** These hubs are connected to the correspondingly numbered hubs labeled *Punch Communication* on the process control panel.

17. **Punch Repeat.** When an impulse is wired to Punch Repeat IN (P or D), one additional card will automatically be punched from the same output track data.

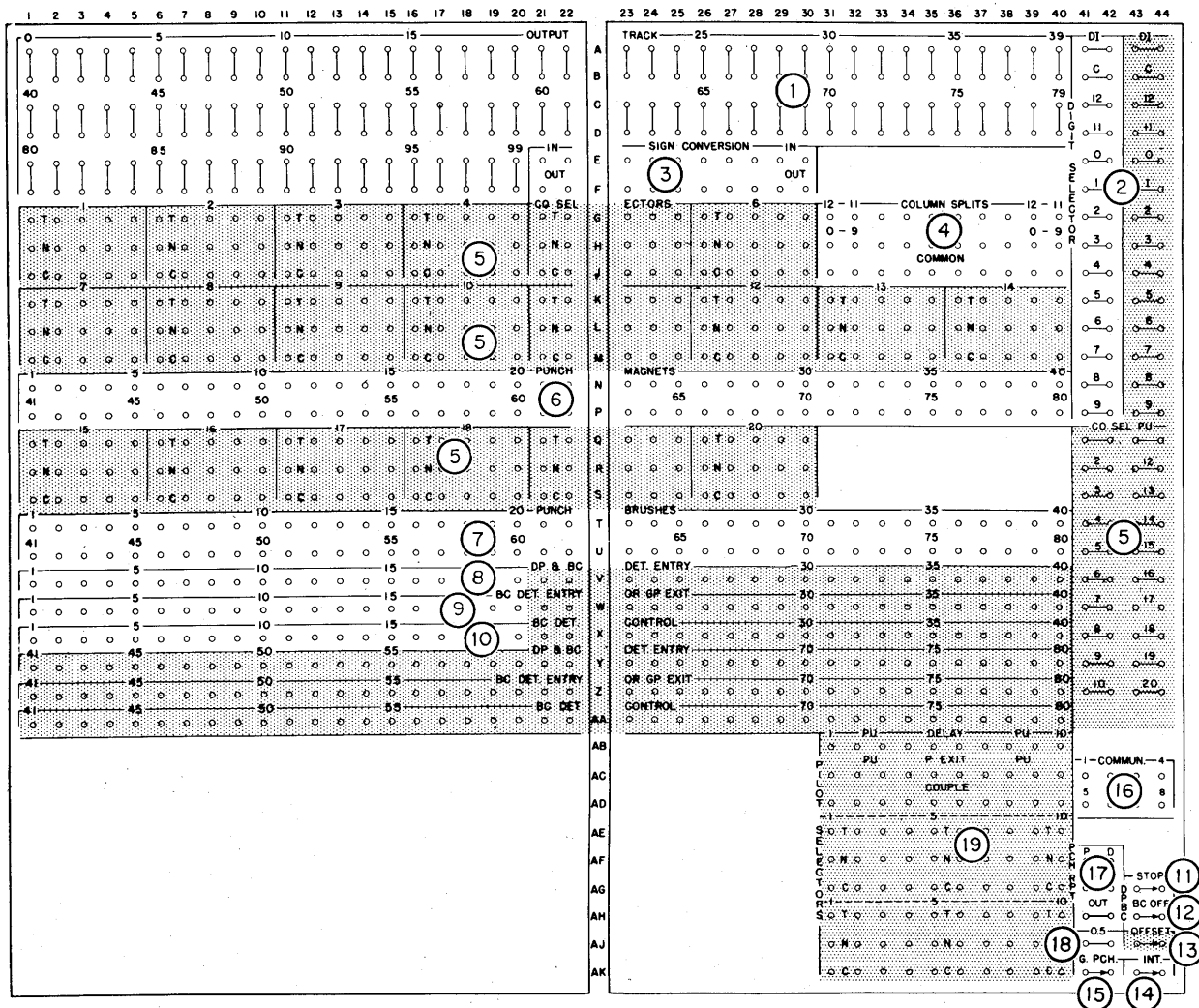

Figure 144. 323 Punch Control Panel

If selectors are used, two cards with different formats can be obtained from the single output track. Without selectors, two identical cards are punched.

When Punch Repeat has been impulsed, the OUT hub on the Punch Control Panel will emit just prior to punching time of the second card. This impulse may be wired to the D pickup of pilot selectors or to Co-selector pickups to control the punching for the second card.

A program exit wired through a communication channel for the purpose of impulsing punch repeat must be wired to the P (program exit) pickup. Also, the program exit that is wired to punch repeat must be the same program exit that is wired to PUNCH on the Process Control Panel.

Digits or couple exits used to impulse punch repeat must be directed to the D (digit) pickup for correct operation. As in the case of the P pickup when the D pickup of punch repeat has been impulsed, the OUT hub will emit just prior to punching time of the second card.

More than one additional card can be punched by impulsing Punch Repeat IN on successive punch cycles. The number of additional punch cycles can be controlled by the use of pilot selectors.

Punch Repeat will maintain its proper status during error restart procedures.

18. Half-After-Zero (0.5). This hub emits an impulse after zero time but before one time. It may be used to transfer selectors so that only the digits 1-9 are punched, or to separate the zone and numerical punching of alphabetic fields so that they can be wired for DPBC detection.

19. Pilot Selectors. Two groups of five 2-position Pilot Selectors may be installed as a special feature.

If a Program Exit is wired through a Communication Channel for the purpose of impulsing a Pilot Selector, the Program Exit must be wired to the P EXIT pickup. Improper operation will result if a Program Exit is wired to any other selector pickup. When the P EXIT pickup is impulsed, the selector will transfer immediately and will remain transferred for the duration of the associated punch cycle. The Program Exit that is wired to the P EXIT pickup must be the same Program Exit that is wired to PUNCH on the Process Control Panel.

It is possible to impulse the P EXIT pickup from a digit impulse; however, if an output error should occur, the selector will remain transferred throughout a run-out and run-in procedure. On a run-out and run-in procedure the last punched card is repunched on the run-in, and because the selector would be transferred during the repunching of the last punched card, operations such as split column control would not function properly.

The DEL (delay) pickup may be wired from any digit impulse, COUPLE, or from the Punch Repeat OUT hub. It cannot be impulsed by a Program Exit wired through a Communication Channel. When the DEL pickup is impulsed, the selector will transfer one punch cycle later, and will remain transferred for one cycle. In the event of an output error, selector control will be automatically maintained.

Associated with each Pilot Selector is a COUPLE hub. If a Pilot Selector is transferred by impulsing the P EXIT pickup from a Program Exit, the COUPLE hub will emit just prior to punching time for that card. If a selector is picked up by impulsing the DEL (delay) pickup, the COUPLE exit will emit one cycle later just prior to punching time.

If it is desirable to expand the number of available positions of a Pilot Selector, the COUPLE exit may be wired to a Co-selector pickup. The Co-selector will then function in the exact manner as the Pilot Selector. COUPLE may also be wired to the DEL pickup of another Pilot Selector to cause it to transfer one cycle later.

Typewriter Control Panel (Figure 145)

1. **Column Control Exits.** When the typewriter is being used for inquiries or for printing an auxiliary document, these hubs sequentially emit impulses that coincide with the reading of the corresponding position of the typewriter Q track. These impulses control the format of the information being printed.

The first Q track position to be read is controlled by wiring the COLUMN CONTROL ENTRY (item 13). Subsequently, the machine reads succeeding positions until the control is transferred elsewhere. This arrangement allows the typewriter to type fields from the typewriter track in any order.

If at any time the program unit or the column control delay are turned on, the COLUMN CONTROL EXITS stop emitting, but the same sequential position is held, unless the COLUMN CONTROL ENTRY is impulsed to transfer control to another position. When the PROGRAM ON hubs are impulsed, column control is turned off until COLUMN CONTROL ON is impulsed. When COLUMN CONTROL DELAY is impulsed, on the following cycle an impulse is emitted from the CCD hub, and then column control is turned on again automatically.

2. **Program Exits.** When PROGRAM ON is impulsed, these hubs sequentially emit impulses when the typewriter is being used for inquiries or for printing an auxiliary document. These impulses are used for typewriter control and to type constants, legends and special characters not on the typewriter track. Until the program is turned off by impulsing COLUMN CONTROL ON, the program advances through steps 0-4 in levels A-E. When the program is first turned on after the final dropout of the previous operation, PROGRAM EXIT A0 will emit, followed by A1, A2, A3, A4, B0, B1, B2, etc. The program impulses may be started at another point by impulsing PROGRAM ENTRIES (item 12).

3. **Digit Selector.** It is sometimes desirable to know the contents of a certain typewriter track position so that format control may be altered on the basis of the character coding. When the PU hub is impulsed from a COLUMN CONTROL EXIT, the character in that position is analyzed and emitted in IBM code from the hubs labelled 12-9. While this is taking place, the printing of the character is suppressed.

4. **CCD (Column Control Delay).** Whenever COLUMN CONTROL DELAY is impulsed, the CCD hubs emit an impulse that may be used for spacing or other functions. Column control is suspended for the cycle on which these hubs emit. After one cycle, the column control resumes from the step after the one on which the control was impulsed (item 21).

5. **Column Split (X-NX).** When COLUMN SPLIT is impulsed, on the next cycle column control is suspended and either the X- or NX-hub will emit. The X-hub emits if the character being analyzed by the column split device contained an X-bit. If no X-bit was present, the NX-hub emits (item 24).

6. **0 TR (Zero Transfer).** Whenever the zero transfer feature is turned on by impulsing ZERO SUP ON, (Item 22), a zero read

from the typewriter track is not printed, but an impulse is emitted from these hubs. This impulse may be wired to SPACE (Item 20) to maintain vertical column alignment.

7. **100 (Type 100).** Impulsing these hubs causes all 100 characters to be typed from the typewriter track, in position sequence, without format control.

8. **Format.** These hubs emit control impulses when the corresponding format key is depressed on the keyboard. The impulses from these hubs may be used to set selectors to establish format control for three different types of inquiries and to start the typewriter control panel program.

9. **Type.** When the TYPE hubs are impulsed on the process control panel, the typewriter TYPE hubs emit an impulse that may be used to control format for lines typed out under stored program control and to start the typewriter control panel program.

10. **Selectors.** Ten 2-position selectors are provided to facilitate format control. Normally a connection exists between each c hub and the N hub above it. When an impulse is wired to the PU hub this connection is broken and the c hub is connected to the T hub above it. This connection remains until the DO (dropout) hub is impulsed.

11. **Distributors.** Impulses that are used to initiate several functions are wired through distributors that serve the same function as split wires but prevent possible back circuits. An impulse wired into the IN hub of a distributor is available at the associated OUT hubs, but impulses cannot travel between OUT hubs, or from an OUT hub to the IN hub. Any impulse except that from the OUT hub of another distributor may be wired through a distributor.

12. **Program Entry (Also item 2).** To establish the beginning of a sequence of program impulses, one LEVEL hub and one STEP hub are impulsed in the same manner that the PROGRAM ENTRIES are impulsed on the process control panel. The program unit is turned on automatically by impulsing PROGRAM ENTRY without impulsing program on.

13. **Column Control Entry.** To establish the beginning of a sequence of column control (item 1), one TENS and one UNITS hub are impulsed in the same manner that the PROGRAM ENTRIES are impulsed on the process control panel. Column control is turned on automatically by impulsing COLUMN CONTROL ENTRY without impulsing COLUMN CONTROL ON.

COLUMN CONTROL ENTRY must not be impulsed at the same time as COLUMN SPLIT.

14. **Type Only.** When these hubs are impulsed from program exits or CCD, the corresponding characters are typed.

15. **Clear.** Impulsing these hubs causes the typing to stop and the carriage to return.

16. **Column Control On.** These hubs are impulsed to restore the typewriter to column control after program control has been used, if it is desired to restart from the track position after the last position used previously. Column control is turned on automatically if a column control entry is made. Program control is turned off.

17. **Program On.** These hubs are impulsed to place the typewriter under program control. Column control is turned off. Program control is turned on automatically when a program entry is made.

18. **Carriage Return.** Impulsing these hubs causes the typewriter carriage to return to the home position.

19. **Tabulate.** Impulsing these hubs causes the carriage to tabulate to the next tab stop.

20. **Space.** Impulsing these hubs causes the typewriter to space one space.

21. **Column Control Delay (Item 4).** When these hubs are impulsed, column control or program control (whichever is in effect) is suspended for one cycle, during which an impulse is emitted from

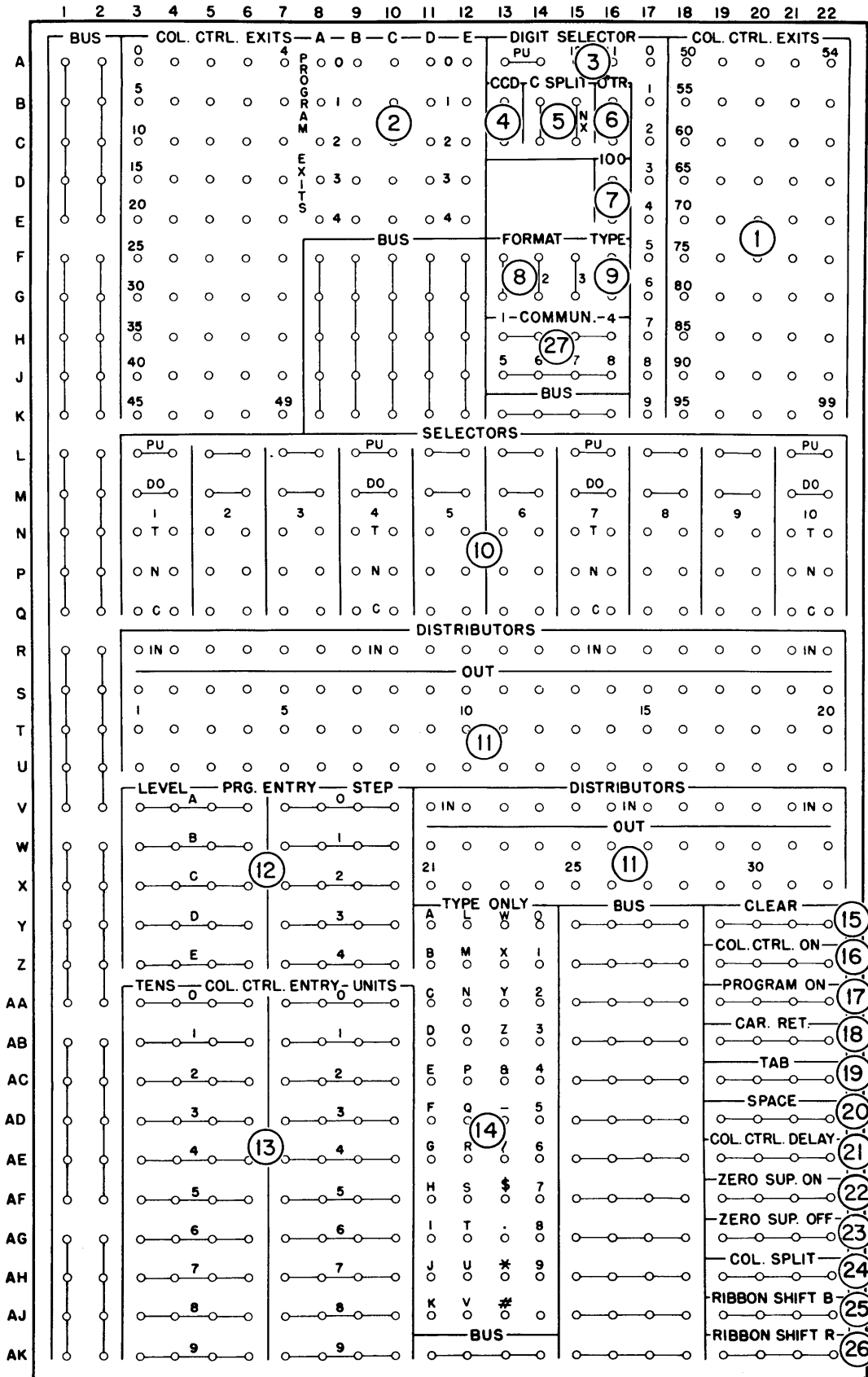

Figure 145. 380 Console Control Panel — Form 22-6329

the CCD hub (item 4). Column control or program control resumes control immediately after this cycle, continuing from the step after the step that was wired to impulse the delay.

22. **Zero Suppression On (Also item 6).** When this hub is impulsed, if a zero is read from the typewriter track it will not be typed, but an impulse will be emitted from the 0 TR hubs (item 6) which may be wired to cause spacing or some other function. The printing of zeros is resumed when the OFF hub is impulsed (item 23) or when a character other than zero is read from the track. This arrangement allows the zeros in the high-order position of fields to be suppressed. Zero Suppression ON is impulsed one position before it is to become active.

23. **Zero Suppression Off.** These hubs are impulsed to turn the zero suppression feature off when it is desired to print zeros to the left of significant digits, and the feature has been turned on by previous wiring. Zero Suppression OFF occurs immediately.

24. **Column Split.** Impulsing these hubs causes the column split device to analyze the character being typed for the presence or absence of an X-bit. On the next cycle, column control is automatically suspended and the COLUMN SPLIT X- or NX-hub will emit. When COLUMN SPLIT is impulsed from a COLUMN CONTROL EXIT, the corresponding Q track character will type only as a numerical digit. COLUMN SPLIT must not be impulsed at the same time as COLUMN CONTROL ENTRY.

25. **Ribbon Shift Black.** Impulsing this hub causes the typewriter to type through the black portion of a two-color ribbon.

26. **Ribbon Shift Red.** Impulsing this hub causes the typewriter to type through the red portion of a two-color ribbon.

27. **Communication.** These hubs connect to the correspondingly numbered hubs on the 305 Process Panel to allow signal communication between the processing unit and the console.

Systems Summary

Stored Program Coding

The stored program codes are repeated here for reference:

	FROM	TO
Processing Storage Tracks (Standard Machine)	W	W
	X	X
	Y	Y
	Z	Z
Processing Storage Tracks (Special Feature)	U	U
	/	/
Program and General Storage Tracks	#	#
	0	0
	1	1
	2	2
	3	3
	4	4
	5	5
	6	6
	7	7
	8	8
	9	9
	&	&
	A	A
	B	B
	C	C
	D	D
	E	E
F	F	
G	G	
H	H	
I	I	
Accumulator		L
Add		M
Subtract		
Read out and reset	M	V99
Read out	L	N99
Multiplicand	V	K
Multiplier		
Input Track	K	S
Output Track (Standard Machine)	S	R99
Disk Memory	R99	J
Address Register		-99
Character Selector		Q
Inquiry Track	Q	
Magnetic Core Unit	-99	
Punch Output Track (Special Feature)	S	S
Printer Output Track (Special Feature)	T	T

Control Operation Codes

These codes, in the ninth position of the instruction, cause the program to be brought to the control panel on the corresponding hubs.

A-Z, 0-9, . □ & \$ * - / , % # @ (47 characters)

Control Codes (10th Position)

These codes, in the tenth position of the instruction, operate as follows:

1: Compare the information in the TO and FROM locations — 1 to 100 columns.

2: Field compare from one to ten 10-position fields of a track specified by the FROM address with the fields of a track specified by the TO address.

3: Combined compare causes both the regular compare and field compare devices to compare information.

4: Suppress automatic sequencing of dual access.

5: Cause an accumulator to reset before an add, subtract, or multiply operation.

6: Checks a transfer for all blanks or zeros — Blank Transmission.

Approximate Operating Times

NOTE: All operating times included in this manual are approximate at the time of publication, and are subject to change. They are included to assist in programming.

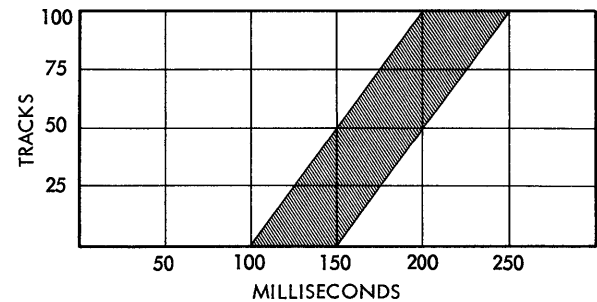

Figure 146. Seek Time for Access Arm moving from one track to another track on same disk

Seek Access Time. Figure 146 shows graphically the access time when the arm is moved between tracks on the same disk. For example, if the arm is moved from track 05 to track 55, a distance of 50 tracks, the access time will be from 150-200 milliseconds.

NOTE: If a seek calls for a record on the same track, the operation is completed in 50 milliseconds, the time to execute the seek instruction.

Figure 147 shows the range in access time when the arm is moved from an address on one disk to an address on another disk. For example, if the arm is moved from disk 15 to disk 40, a distance of 25 disks, the total access time will be from 550-650 milliseconds, depending on the number of tracks traversed.

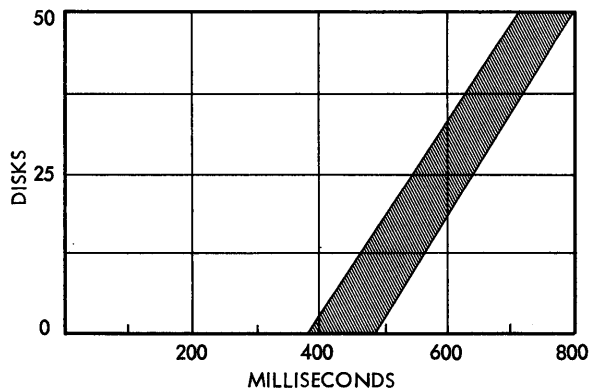

Figure 147. Seek Time for Access Arm moving from track on one disk to track on another disk

Card Feed Input (125 cpm maximum) 480 ms/card

Printer Output

80 positions	(29 lpm)	2050 ms/line
60 positions	(36.5 lpm)	1640 ms/line
40 positions	(50 lpm)	1200 ms/line
20 positions	(84 lpm)	720 ms/line
Punch Output	(100 cpm max.)	600 ms/card

Processing Control Unit

Transfer between drum tracks	30 ms/step
Transfer disk to drum track:	
	80 ms max., 55 ms avg., 30 ms min.

Transfer drum to disk:

	130 ms max., 105 ms avg., 80 ms min.
Control Panel Test	additional 20 ms.
Record Advance	additional 30 ms.
Skip-To-Record	additional 30 ms.
Seep Operation TO J	additional 20 ms.
Cycle Delay	additional 30 ms.

The Printer Output Graph shown in Figure 148 may be used as an aid when computing printing speeds.

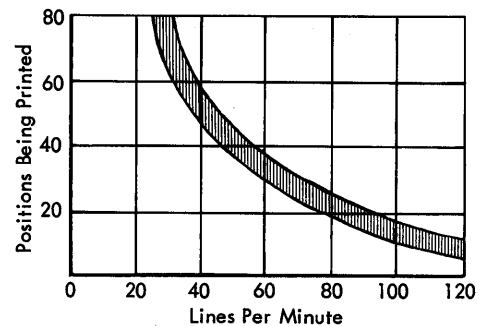

Figure 148. 370 Printer Speeds

Feature Summary

Features of the 305 RAMAC are summarized below. For each feature, the table indicates the number included in the standard machine, the units in which each optional addition may be made and the maximum available capacity.

<u>305 Features</u>	Standard	Increment	Maximum
Character selectors	3*	3	6
Distributors	100	20	120
Selectors	10	10	40
<u>323 Features</u>	Standard	Increment	Maximum
Co-selectors	0	4**	20
Pilot Selectors	0	5≠	10
Digit Selector	1	1	2
Offset Stacker	0	1	1
DPBC positions	20	10	80
<u>370 Features</u>	Standard	Increment	Maximum
Co-selectors	4**	4**	12**
Skip Stops	6	5	11

* One 48-position character selector standard.
 ** 5-position
 ≠ 2-position

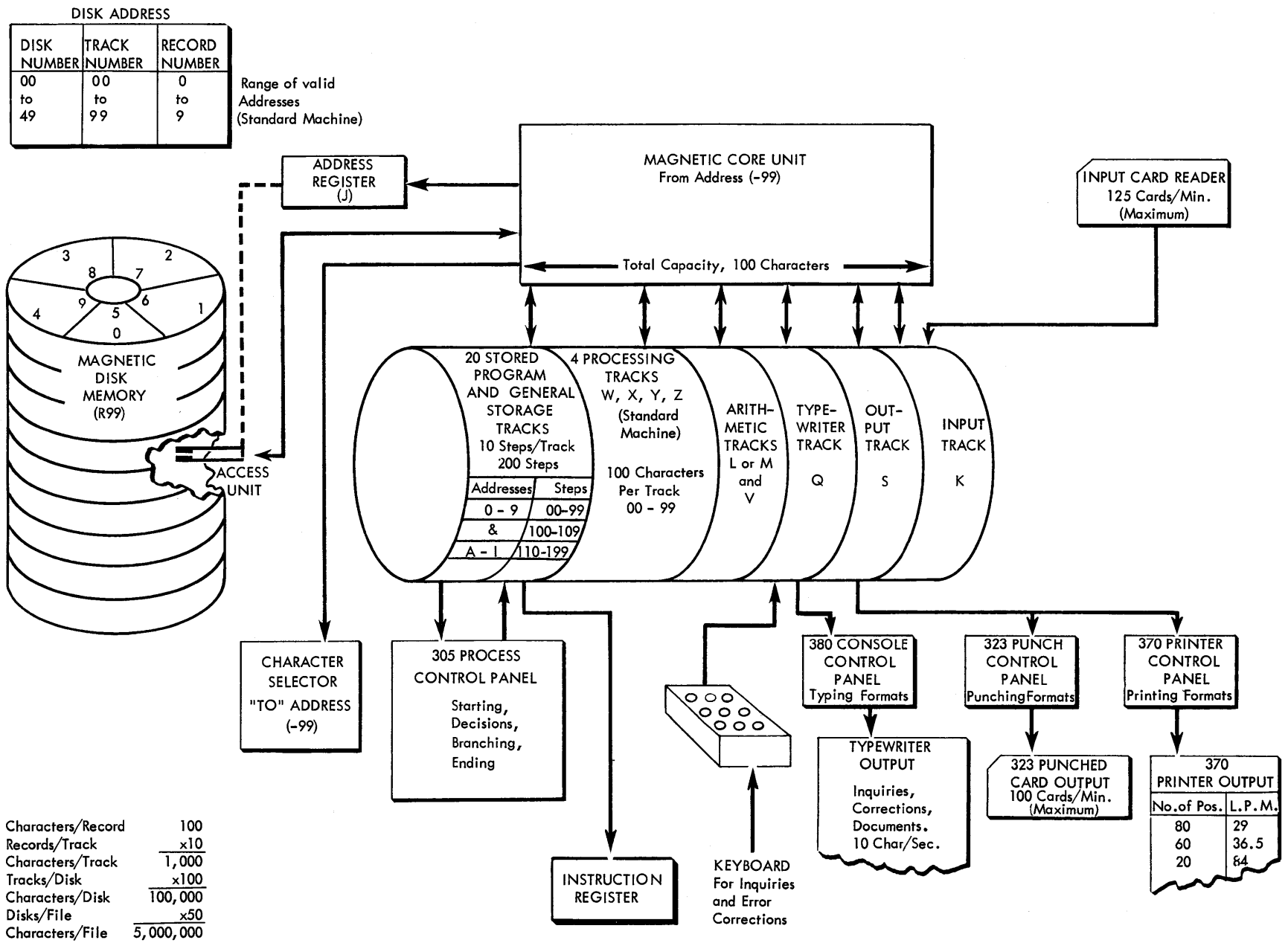

Figure 149. Summary of the 305 System

Index

	<i>Page</i>		<i>Page</i>
Accumulator Add	32	Character Keys (Keyboard)	76
Accumulator Overflow Light (380)	73	Character Selector	45, 167
Accumulator Overflow Selectors	34, 167	Character Selector Lights (380)	73
Accumulator Readout	32	Check Light (370)	101
Accumulator Readout and Reset	32	Check Reset Key (323)	126
Accumulator Sign Light (380)	73	Check Reset Key (370)	101
Accumulator Sign Selectors	34, 167	Check Reset Key (380)	69
Accumulator Subtract	32	Checking, Automatic Machine	63
Accumulators	30	Clear Hubs (380)	85, 174
ACI Hubs (370)	102	Clear Key (Keyboard)	76
Add	32	Clearing Disk Storage	39
Additional 350 Disk Storage	160	Clock Check	66, 135
Address Register	25	Clock Error-Correction	135
Address Summary of the 305 System	177	Clock Light (380)	74
Addressing, Programmed	25	Co-Selectors (323 Special Feature)	149, 172
Advantages, RAMAC Approach	7	Col Ctr On Hubs (380)	85
ALC Hubs	45, 169	Column Control Delay Hubs (380)	86, 174
Alter Key (Keyboard)	76	Column Control Entry Hubs (380)	84, 174
Alteration Switches (380)	69, 167	Column Control Exit Hubs (380)	82
Alteration Switch Selectors	46, 167	Column Control On Hubs (380)	85, 174
Alterations to Drum Tracks (Console)	80	Column Split Hubs (323)	127, 172
Alternate Method of Divisor and Dividend Positioning	159	Column Split Hubs (380)	89, 176
Analyzer Control Impulse Hubs (370)	102	Column Split X-NX Hubs (380)	89, 174
Analyzer Exit Hubs (370)	102, 171	Combined Compare	30
Approximate Operating Times	177	Combining Sequencing and Selective Use of Access Units	164
Arithmetic Operations	30	Common Operator Errors	148
Asterisk Protection (370)	145	Communication Channel Wiring	145
Automatic Last Card Hubs	45, 169	Communication Hubs (305)	48, 167
Automatic Machine Checking	63	Communication Hubs (323)	130, 172
Automatic Sequencing	161	Communication Hubs (370)	108, 171
		Communication Hubs (380)	84, 176
BC Det Control Hubs (323)	130, 172	Compare Hubs	28, 167
BC Det Entry or GP Exit Hubs (323)	129, 172	Comparing	27
BC Off Hubs (323)	129, 172	Console	11, 68
Blank Column Off Hubs (323)	129, 172	Console Control Panel	82, 175
Blank Transmission Light	73	Console Keyboard Functions	75
Blank Transmission Selectors	45, 167	Console Operating Procedures	78
Black Ribbon Shift	91	Console Reading Aid	148
		Console Typewriter	82
Card Punch	10, 125	Constructing a Sector Index and Storing a Record	53
Card Reader	9, 68	Control Buttons (380)	71
Carriage (370)	108	Control Codes	17, 177
Carriage Control Tape	110	Control Impulse (380)	71
Carriage Operating Features	91	Control Impulse Hubs	45, 169
Carriage Release (380)	96	Control Keys (380)	69
Carriage Return Key (Keyboard)	76	Control Operation Codes	177
Carriage Return Hubs (380)	85, 174	Control Panel Summary	167
CCD Hubs (380)	86, 174	Control Panel Summary (305)	167
Chaining	58	Control Panel Summary (323)	172
Changing 370 Printer Ribbon	115	Control Panel Summary (380)	174
Changing Hammer Platen	115	Control Panel Summary (370)	169
Character Coding System	63	Control Selector Switch (380)	70
		Control Stop Light (380)	75

	<i>Page</i>
Control Switches (380)	69
Control Tape	110
Copy Hubs	23, 169
CR (Keyboard)	76
Cycle Delay Hubs	45, 155, 169
Cycle Lights (380)	73
DC Off Key (380)	69
DC On (380)	72
Delta Δ (370)	108, 171
DI Hubs, Digit Impulse (323)	130
Digit Selector (323)	131, 172, 174
Digit Selector (380)	91
Disk Storage	25
Disk Storage Loading	41
Disk Storage Organization	49
Disk Storage Unloading	44
Distributors (305)	18, 169
Distributors (370)	106, 171
Distributors (380)	84, 174
Division-Direct (Special Feature)	155
Division-Programmed	36
Divisor and Dividend Positioning	155, 157
Divisor and Dividend Positioning, Alternate Method of	159
Double Punch and Blank Column Detection	127
DP & BC Det Entry Hubs (323)	129, 172
DP and BC Light (323)	127
DP and BC Restart	138
DPBC Stop Hubs (323)	130, 172
Drum	14
Dual Access	160
Dual Access as Single Access System	162
Dup Key, Duplicate Key (Keyboard)	76
Eighty-Two Rule of Activity	58
Eighty-Two Rule Procedure	61
Eighty-Two Rule, Typical Curves	62
Error Correction (Console)	134
Error Correction Procedures	134
Error Correction Procedures (323)	138
Examples of Console Operation	78
Expansion of Program Exits	144
Feature Summary	178
Feed and Punch Unit	126
Feed Card	20, 169
Feed Check	64
Feed Check Light (380)	72, 135
Feed Check Light (323)	126, 138
Feed Check Stop (380)	135
Feed Check Stop-Correction (380)	135
Field Compare	28
Field Compare Hubs	28, 167
Field Compare Lights (380)	73
File Check	65, 135
File Check Light (380)	74, 135
File Check-Correction	135
File Error Check	135
File Interlock Hubs	41, 169
File Loading	41
File Unloading	44
First Printing Line, Locating (370)	115
Form Control (370)	115
Form Feeding (380)	98
Form Light (370)	101, 137
Form Perforation Printing Limits	112
Form Sizes and Design (370)	112
Format Hubs (380)	82, 174
Format Keys (380 Keyboard)	75
Forms Thickness Adjustment Device (370)	114

	<i>Page</i>
Forms Tractor Clutch	113
From Address, Program Instructions	16
From Cycle	17
Gangpunch, G Pch (323)	130, 172
General Storage Tracks	15, 153
General Wiring Rules	139
Half Adjustment	36
Half Adjustment, Division	156
Half Adjustment, Multiplication	36
Half-After-Zero, 0.5 (323)	132, 173
Hammer Platen, Changing of	115
How to Change Typewriter Ribbon	97
Hundreds Program Entry, Program Entries	18
IBM 305 RAMAC Approach-Inventory Billing and A/R Application	7
IBM Punched Card Approach-Inventory Billing and A/R Application	5
Impression Control, Hammer Platen (370)	91
Impression Control (380)	96
Impression Indicator (380)	91
Indexing	52
Indicative Information	116
Indicator Lights (380)	71
Indirect Addressing	50
In-Line Processing	5
Input Track	18
Inquiries (Console)	79
Inquire Hubs	47, 169
Inquiry Light (380)	74
Inquiry-Type Interlock Hubs	47, 169
Inserting a New Form (370)	114
Inserting the Tape (370)	110
Instruction Cycle	17
Instruction Lights (380)	72
Instruction, Program	16
Interlock Hubs (370)	102, 171
Interlock Hubs, Int (323)	130, 172
Interlock Light (380)	74
Interlocked Track, Investigating	136
Internal Checking	63
Investigating Interlocked Track	136
ITI Hubs	47
K Test-K Run	70
K Track	18
Keyboard (380)	77
Keyboard Functions	75
Keys and Levers (380 Typewriter)	91
Keys and Lights (323)	126
Keys and Lights (370)	100
Last Card Light (380)	73
Last Card Operation	47
Last Card Selectors	47, 167
Latch-Type Selectors	154
LC Light (380)	73
Lights (323)	126
Lights (380)	71
Lights (370)	101
Limits, Form Perforation Printing	112
Line End Hubs (370)	107, 171
Line Position Reset	96
Line Program Impulse Hubs (370)	122, 171
Line Program Selectors (370)	105, 171
Line Space Hubs (370)	119, 171
Line Space Lever (380)	97
Load Rating	140

	<i>Page</i>		<i>Page</i>
Loading Disk Storage	41	Print Control Exit Hubs (370)	105, 169
Loading the Program	21	Print Control Functional Hubs	106
Locating First Print Line (370)	115	Print Cycle	101
Locating the Record During Processing, Index Method	58	Print Hubs (305)	20, 169
		Print Position Exit Hubs (370)	102, 172
Machine Checking, Automatic	63	Print Repeat Switch (370)	114
Machine Components	9	Print Space Hubs (370)	102, 172
Machine Schematic	11, 149	Print Start Hubs (370)	107, 171
Magnetic Core Unit	16	Print Stick	99
Main Line Power Switch (370)	101	Print Stop Hubs (370)	107, 171
Main Line Power Switch (323)	126	Printer (370)	99
Margin Release Key, Typewriter	91	Printer Control Panel (370)	101, 169
Margin Reset, Left Hand	93	Printer Control Panel Entries	124
Margin Reset, Right Hand	93	Printer Keys and Lights	100
Margin Set Key	93	Printer Output Track (Special Feature)	153
Master Power-Off	69	Printer Ribbon, Changing of	115
MLP Hubs (370)	120, 171	Printing Limits, Form Perforation	112
Multiple Copy Control (380)	97	Printing Overflow Indicative Information	116
Multiple Line Printing	120	Process Control Panel	13, 168
Multiplicand Track	34	Process Tracks	15, 153
Multiplication	34	Processing Control Unit	178
		Processing Drum	14
Non-Process Runout Key (380)	69	Processing Errors	134
NX - Eliminate Hubs (370)	107, 171	Processing Unit	9, 153
		Program Advance	18, 169
OF Hubs (370)	116, 171	Program and General Storage Tracks	15
Off-Set Stacking Feature (323 Special Feature)	152, 172	Program Entry Hubs (380)	84, 174
On-Off Lever, Typewriter	93	Program Entry Hubs (305)	17, 169
Operating Hints	148	Program Entry Isolation	154
Operating Features, Carriage	113	Program Exit Expansion	144
Operating Features (380 Typewriter)	91	Program Exit Hubs (305)	17, 167
Operating Keys and Lights (323)	126	Program Exit Hubs (380)	84, 174
Operating Keys and Lights (370)	100	Program Exit Split	153
Operating Speeds	9	Program Instruction	16
Operating Times, Approximate	177	Program Load Button (380)	22, 71
Other Control Panel Functions (323)	130	Program Loading	21
Other Control Panel Hubs (370)	108	Program Loading Load Cards	21
Other Logic Elements (305)	45	Program On Hubs (380)	85, 174
Other Wiring Rules	140	Program Selector Switches (380)	71
Output Check	66	Program Set Key (380)	69
Output Printer	10	Program Start Key (380)	69
Output Track	20	Program Step (380)	72
Output Track Hubs (323)	127, 172	Program Step Indicators (380)	72
Output Track Hubs (370)	102, 172	Program Stop Key (380)	69
Overall Machine Schematic	11	Program Testing, Console	80
Overflow Hub (370)	116, 171	Program Tracks	15
Overflow Indicative Information	116	Program-On Hubs (380)	85
Overflow Light, Accumulator (380)	73	Programmed Division	36
Overflow Selector, Accumulator	34	Punch Brush Hubs (323)	127, 172
		Punch Feed Check	138
Paper Release Lever (380)	97	Punch Control Panel	127, 173
Paper Scale (380)	97	Punch Hubs (305)	20, 169
Parity Check	65	Punch Interlock	130
Parity Check - Correction	134	Punch Repeat	131, 172
Parity Error (370)	136	Punch Unit	126
Parity Error (323)	134, 137	Punching the Tape (370)	110
Parity Light (323)	126, 137	Punch-Magnet Hubs (323)	127, 172
Parity Light (380)	74		
Pilot Selectors (323 Special Feature)	149, 173	Q Track, Typewriter Output	20
Pin Feed Platen (Typewriter)	98		
Platen, Changing (370)	115	Random Access Method of Accounting and Control	5
Platen Removal (Typewriter)	98	Read Check	64, 135
Platen Variable	97	Read Check Light	72, 135
Power Off (380)	69	Read Check Stop - Correction	135
Power Off, Master (380)	69	Read From and To Disk Storage	26
Power On Key (380)	69	Read Key (Keyboard)	75
Power On Light (323)	127	Read Out and Reset	33
Power On Light (370)	101	Reader Power Light	72
Power On Light (380)	71	Reader Ready Light	72
Print Check - Correction	136	Reader Start Key (380)	69

	<i>Page</i>		<i>Page</i>
Reader Stop Key (380)	69	Summary of 305 System	177
Readout, Accumulator	32	Symbols Hubs (370)	108, 171
Readout and Reset, Accumulator	32	System Organization	9
Ready Light (323)	126	Systems Summary	177
Ready Light (370)	101		
Record Advance Hubs	27, 167	Tab Clear Key, Typewriter	91
Red Ribbon Shift	91	Tab Set Key, Typewriter	93
Removing the Platen (380)	98	Tabulate Hubs (380)	86, 174
Reset Hubs (305)	45, 169	Tape Inserting	110
Reset Key (370)	101	Tape Punching	110
Reset Key (380)	69	Tape-Controlled Carriage	10, 108
Reset Light (380)	75	Test Light (380)	74
Reset Stop Hubs	43, 169	Test Lock	71
Reset-Add	32	Testing a Program (Console)	80
Reset-Multiply	36	Testing Procedures (Console)	80
Reset-Subtract	32	Testing Typewriter Format	80
Restart Procedures	134	Timing Chart (323)	132
Restarting the Same Job	78	Timing Chart (370)	123
Restore Key, Carriage	113	T-Track (Special Feature)	153
Ribbon 370, Changing	115	To Address, Program Instructions	16
Ribbon 380, Changing	97	To Cycle	17
Ribbon Shift Black Hubs (380)	89, 176	Track Clearing	21, 81
Ribbon Shift Red Hubs (380)	89, 176	Type 100 (380)	89, 174
Ribbon, Typewriter	97	Type Hubs (380)	82, 174
		Type Hubs (305)	21, 169
Schematic of the Complete Machine	11, 179	Type Only Entry (380)	89, 174
Select Lights (380)	73	Typewriter Column Light (380)	73
Select Mode of Operation	162	Typewriter Control Panel	82, 175
Selective Use of Access Units	162	Typewriter Format, Testing of	80
Selector Lights (380)	73	Typewriter Impression Indicator	91
Selectors (305)	45, 154, 169	Typewriter Margin Release Key	91
Selectors (370)	105, 172	Typewriter Output	20
Selectors (380)	85, 174	Typewriter Ribbon, How to Change	97
Sign Control, Accumulator	33	Typewriter Tab Set Lever	93
Sign Control, Division	155	Typical Curves Obtained Using 80-20 Rule	62
Sign Conversion Hubs (323)	127, 172		
S-Track	20	Unequal Compare Light (380)	73
Skip-to Hubs (370)	116, 171	Unloading Disk Storage	44
Skip-to Record Hubs	30, 167	Unworkable Problem Consideration, Division	158
Space Bar (Keyboard)	76	Use of Control Panel Distributors	141
Space Hubs (380)	86, 174		
Special Features	149	V Track	34
Speeds of Operations, Approximate	177		
Start Hub (305)	43, 169	Wiring Rules	139
Start Key (323)	126	Wiring and Operating Suggestions	139
Start Key (370)	100	Wiring and Programming Suggestions	144
Starting at a Specific Program Step	78	Working Tracks, General Storage	9, 14, 15
Starting the Machine After a Power Off Condition	78	Write Key (Keyboard)	76
Start-Stop Procedures (Console)	78		
Stick Printing	99	X-Eliminate Hubs	107, 171
Stop Hubs (305)	43, 169	X-No X and O-No O Character Selector	150
Stop Key (323)	126	X-NX Hubs (380)	89
Stop Key (370)	100		
Stop Key, Carriage	113	Zero Suppression Off Hubs (380)	86, 176
Stop Light (380)	72	Zero Suppression On Hubs (380)	86, 176
Stop-Start Procedures (Console)	78	Zero Suppression Start Hubs (370)	107, 171
Stopping at Specific Program Step	78	Zero Suppression Stop Hubs (370)	107, 171
Stored Program	13	Zero Transfer OTR Hubs (380)	89, 174
Stored Program Coding	177		
Subtract, Accumulator	32		

